

# NPN SILICON PLANAR MEDIUM POWER DARLINGTON TRANSISTORS

## ZTX602 ZTX603

ISSUE 1 – MARCH 94

### FEATURES

- \* 80 Volt  $V_{CEO}$
- \* 1 Amp continuous current
- \* Gain of 2K at  $I_C=1$  Amp
- \*  $P_{tot} = 1$  Watt

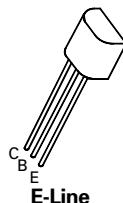

### ABSOLUTE MAXIMUM RATINGS.

PARAMETER	SYMBOL	ZTX602	ZTX603	UNIT
Collector-Base Voltage	$V_{CBO}$	80	100	V
Collector-Emitter Voltage	$V_{CEO}$	60	80	V
Emitter-Base Voltage	$V_{EBO}$		10	V
Peak Pulse Current	$I_{CM}$		4	A
Continuous Collector Current	$I_C$		1	A
Power Dissipation at $T_{amb} = 25^\circ\text{C}$ derate above $25^\circ\text{C}$	$P_{tot}$		1 5.7	W mW/°C
Operating and Storage Temperature Range	$T_j; T_{stg}$		-55 to +200	°C

### ELECTRICAL CHARACTERISTICS (at $T_{amb} = 25^\circ\text{C}$ unless otherwise stated).

PARAMETER	SYMBOL	ZTX602		ZTX603		UNIT	CONDITIONS.
		MIN.	MAX.	MIN.	MAX.		
Collector-Base Breakdown Voltage	$V_{(BR)CBO}$	80		100		V	$I_C=100\mu\text{A}$
Collector-Emitter Breakdown Voltage	$V_{(BR)CEO}$	60		80		V	$I_C=10\text{mA}^*$
Emitter-Base Breakdown Voltage	$V_{(BR)EBO}$	10		10		V	$I_E=100\mu\text{A}$
Collector Cut-Off Current	$I_{CBO}$		0.01 10		0.01 10	$\mu\text{A}$ $\mu\text{A}$ $\mu\text{A}$ $\mu\text{A}$	$V_{CB}=60\text{V}$ $V_{CB}=80\text{V}$ $V_{CB}=60\text{V}, T_{amb}=100^\circ\text{C}$ $V_{CB}=80\text{V}, T_{amb}=100^\circ\text{C}$
Emitter Cut-Off Current	$I_{EBO}$		0.1		0.1	$\mu\text{A}$	$V_{EB}=8\text{V}$
Collector-Emitter Cut-Off Current	$I_{CES}$		10		10	$\mu\text{A}$ $\mu\text{A}$	$V_{CES}=60\text{V}$ $V_{CES}=80\text{V}$
Collector-Emitter Saturation Voltage	$V_{CE(sat)}$		1.0 1.0		1.0 1.0	V V	$I_C=400\text{mA}$ , $I_B=0.4\text{mA}^*$ $I_C=1\text{A}, I_B=1\text{mA}^*$
Base-Emitter Saturation Voltage	$V_{BE(sat)}$		1.8		1.8	V	$I_C=1\text{A}, I_B=1\text{mA}^*$
Base-Emitter Turn-On Voltage	$V_{BE(on)}$		1.7		1.7	V	$I_C=1\text{A}, V_{CE}=5\text{V}^*$

# ZTX602 ZTX603

## ELECTRICAL CHARACTERISTICS (at $T_{amb} = 25^{\circ}\text{C}$ unless otherwise stated).

PARAMETER	SYMBOL	ZTX602		ZTX603		UNIT	CONDITIONS.
		MIN.	MAX.	MIN.	MAX.		
Static Forward Current Transfer Ratio	$h_{FE}$	2K 5K 2K 0.5K	100K	2K 5K 2K 0.5K	100K		$I_C=50\text{mA}, V_{CE}=5\text{V}$ $I_C=500\text{mA}, V_{CE}=5\text{V}^*$ $I_C=1\text{A}, V_{CE}=5\text{V}^*$ $I_C=2\text{A}, V_{CE}=5\text{V}^*$
Transition Frequency	$f_T$	150		150		MHz	$I_C=100\text{mA}, V_{CE}=10\text{V}$ $f=20\text{MHz}$
Input Capacitance	$C_{ibo}$	90 Typical				pF	$V_{EB}=500\text{mV}, f=1\text{MHz}$
Output Capacitance	$C_{obo}$	15 Typical				pF	$V_{CB}=10\text{V}, f=1\text{MHz}$
Switching Times	$t_{on}$	0.5 Typical				$\mu\text{s}$	$I_C=500\text{mA}, V_{CE}=10\text{V}$ $I_{B1}=I_{B2}=0.5\text{mA}$
	$t_{off}$	1.1 Typical				$\mu\text{s}$	

\*Measured under pulsed conditions. Pulse width=300 $\mu\text{s}$ . Duty cycle  $\leq 2\%$

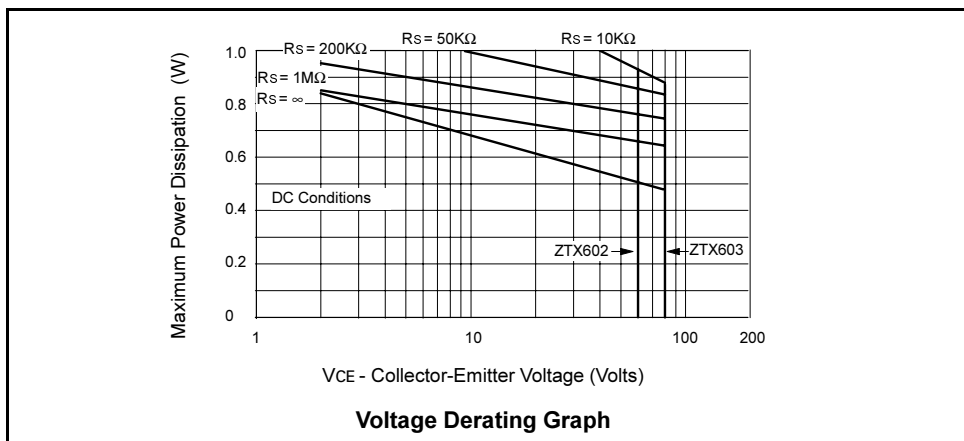

The maximum permissible operational temperature can be obtained from this graph using the following equation

$$T_{amb(max)} = \frac{\text{Power(max)} - \text{Power(act)}}{0.0057} + 25^{\circ}\text{C}$$

$T_{amb(max)}$  = Maximum operating ambient temperature

Power(max) = Maximum power dissipation figure, obtained from the above graph for a given  $V_{CE}$  and source resistance ( $R_S$ )

Power(actual) = Actual power dissipation in users circuit

# ZTX602 ZTX603

## TYPICAL CHARACTERISTICS

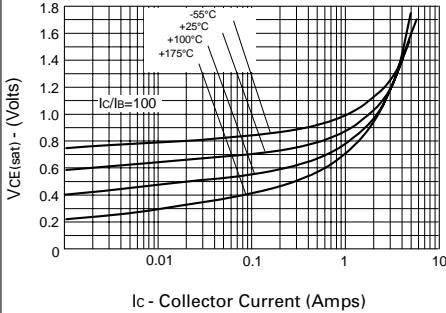

**$V_{CE(sat)}$  v  $I_C$**

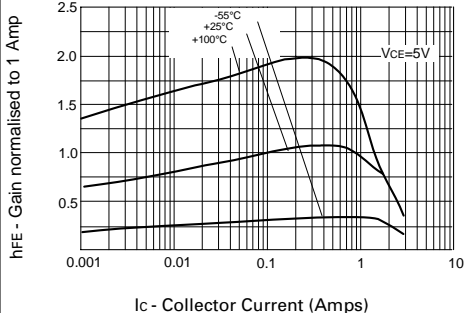

**hFE v  $I_C$**

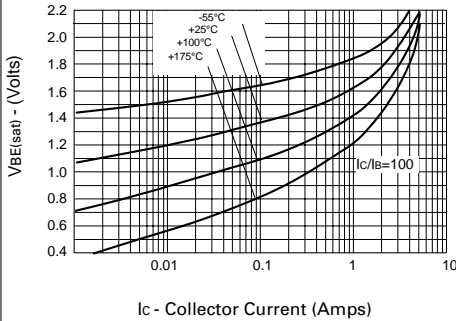

**$V_{BE(sat)}$  v  $I_C$**

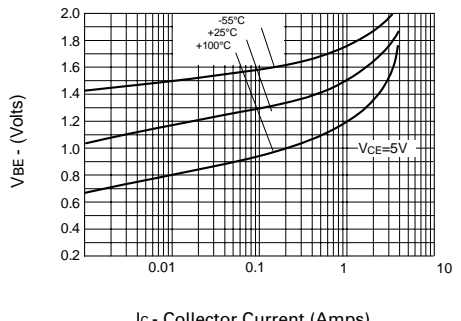

**$V_{BE(on)}$  v  $I_C$**

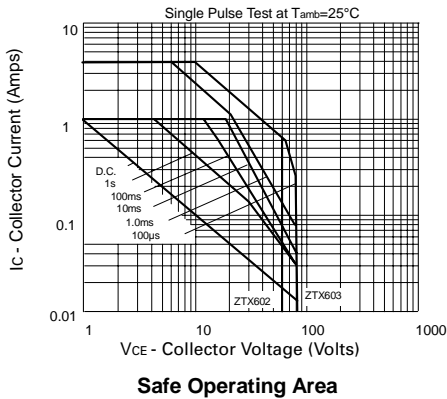

# Mouser Electronics

Authorized Distributor

Click to View Pricing, Inventory, Delivery & Lifecycle Information:

[Diodes Incorporated:](#)

[ZTX603STZ](#) [ZTX603](#)