



## BULD742C

High voltage fast-switching  
NPN power transistor

### Features

- Low spread of dynamic parameters
- High voltage capability
- Minimum lot-to-lot spread for reliable operation
- Very high switching speed

### Applications

- Electronic ballast for fluorescent lighting
- Switch mode power supplies

### Description

The device is manufactured using high voltage Multi-Epitaxial Planar technology for high switching speeds and high voltage capability. Thanks to an increased intermediate layer, it has an intrinsic ruggedness which enables the transistor to withstand an high collector current level during breakdown condition, without using the transil protection usually necessary in typical converters for lamp ballast.

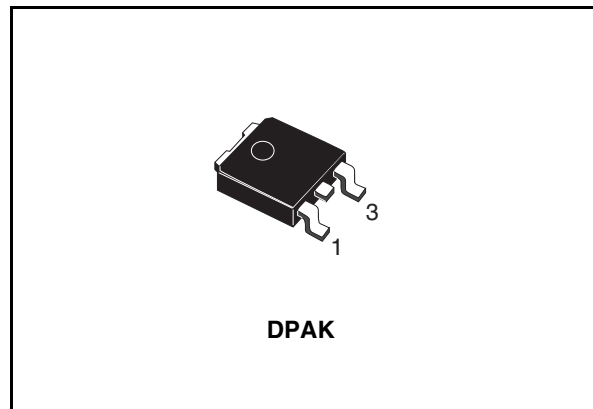

Figure 1. Internal schematic diagram

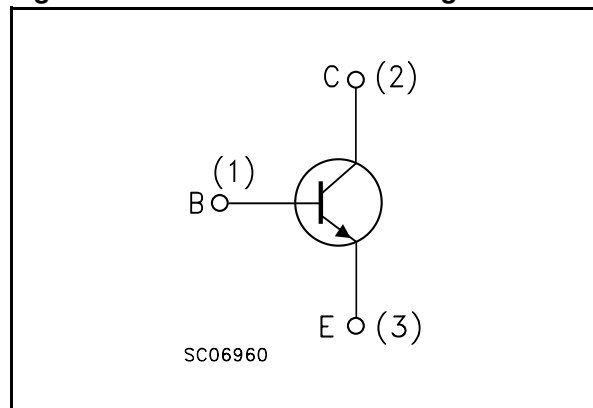

Table 1. Device summary

Order code	Marking	Package	Packaging
BULD742CT4	BULD742C	DPAK	Tape & reel

## Contents

<b>1</b>	<b>Electrical ratings</b> .....	<b>3</b>
<b>2</b>	<b>Electrical characteristics</b> .....	<b>4</b>
	2.1 Electrical characteristics (curves) .....	5
<b>3</b>	<b>Test circuit</b> .....	<b>7</b>
<b>4</b>	<b>Package mechanical data</b> .....	<b>8</b>
<b>5</b>	<b>Packaging mechanical data</b> .....	<b>10</b>
<b>6</b>	<b>Revision history</b> .....	<b>11</b>

# 1 Electrical ratings

**Table 2. Absolute maximum rating**

Symbol	Parameter	Value	Unit
$V_{CES}$	Collector-emitter voltage ( $V_{BE} = 0$ )	1050	V
$V_{CEO}$	Collector-emitter voltage ( $I_B = 0$ )	400	V
$V_{EBO}$	Emitter-base voltage ( $I_C = 0$ , $I_B = 2$ A, $t_p < 10$ ms)	$V_{(BR)EBO}$	V
$I_C$	Collector current	4	A
$I_{CM}$	Collector peak current ( $t_p < 5$ ms)	8	A
$I_B$	Base current	2	A
$I_{BM}$	Base peak current ( $t_p < 5$ ms)	4	A
$P_{tot}$	Total dissipation at $T_C = 25^\circ\text{C}$	45	W
$T_{stg}$	Storage temperature	-65 to 150	$^\circ\text{C}$
$T_J$	Max. operating junction temperature	150	$^\circ\text{C}$

**Table 3. Thermal data**

Symbol	Parameter	Value	Unit
$R_{thj-case}$	Thermal resistance junction - case	2.78	$^\circ\text{C/W}$
$R_{thj-amb}$	Thermal resistance junction - ambient	73	$^\circ\text{C/W}$

## 2 Electrical characteristics

( $T_{\text{case}} = 25^{\circ}\text{C}$  unless otherwise specified)

**Table 4. Electrical characteristics**

Symbol	Parameter	Test Conditions	Min.	Typ.	Max.	Unit
$I_{\text{CES}}$	Collector cut-off current ( $V_{\text{BE}} = 0$ )	$V_{\text{CE}} = 1050 \text{ V}$		0.2	10	$\mu\text{A}$
$I_{\text{CEO}}$	Collector cut-off current ( $I_{\text{B}} = 0$ )	$V_{\text{CE}} = 400 \text{ V}$		10	250	$\mu\text{A}$
$V_{(\text{BR})\text{EBO}}$	Emitter base breakdown voltage ( $I_{\text{C}} = 0$ )	$I_{\text{E}} = 1 \text{ mA}$	15	19	24	V
$V_{\text{CEO(sus)}}^{(1)}$	Collector-emitter sustaining voltage ( $I_{\text{B}} = 0$ )	$I_{\text{C}} = 10 \text{ mA}$	400	450		V
$V_{\text{CE(sat)}}^{(1)}$	Collector-emitter saturation voltage	$I_{\text{C}} = 1 \text{ A}$ $I_{\text{B}} = 0.2 \text{ A}$ $I_{\text{C}} = 3.5 \text{ A}$ $I_{\text{B}} = 1 \text{ A}$		0.15 0.6	0.5 1.5	V V
$V_{\text{BE(sat)}}^{(1)}$	Base-emitter saturation voltage	$I_{\text{C}} = 3.5 \text{ A}$ $I_{\text{B}} = 1 \text{ A}$		1.1	1.5	V
$h_{\text{FE}}^{(1)}$	DC current gain	$I_{\text{C}} = 0.1 \text{ A}$ $V_{\text{CE}} = 5 \text{ V}$ $I_{\text{C}} = 0.8 \text{ A}$ $V_{\text{CE}} = 3 \text{ V}$	48 25	75 35	100 50	
$t_{\text{s}}$ $t_{\text{f}}$	Resistive load Storage time Fall time	$I_{\text{C}} = 2 \text{ A}$ $V_{\text{CC}} = 125 \text{ V}$ $I_{\text{B1}} = -I_{\text{B2}} = 400 \text{ mA}$ $t_{\text{p}} = 300 \mu\text{s}$ $V_{\text{BE(off)}} = -5 \text{ V}$		2.4 350	3.5 500	$\mu\text{s}$ ns
$E_{\text{ar}}$	Repetitive avalanche energy	$L = 2 \text{ mH}$ $C = 1.8 \text{ nF}$ $V_{\text{BE(off)}} = -5 \text{ V}$	6			mJ

1. Pulsed duration = 300 ms, duty cycle  $\leq 1.5\%$

## 2.1 Electrical characteristics (curves)

Figure 2. Safe operating area

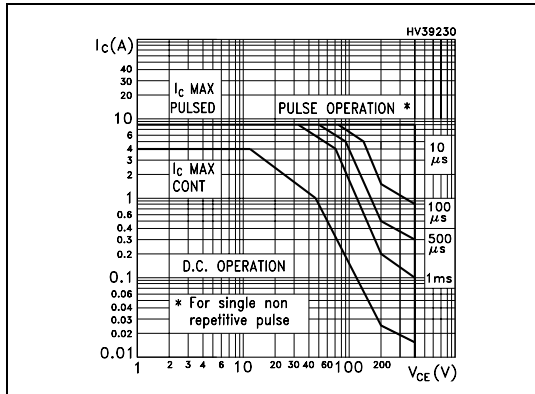

Figure 3. Derating curve

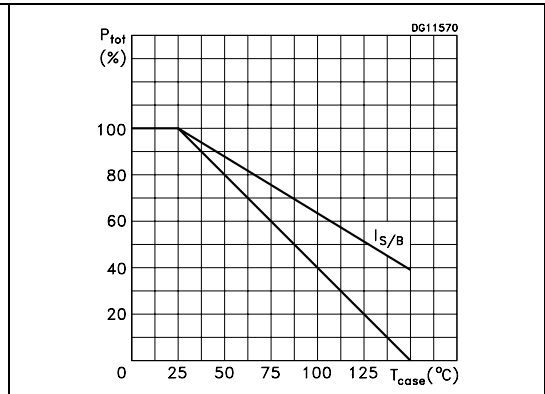

Figure 4. Output characteristics

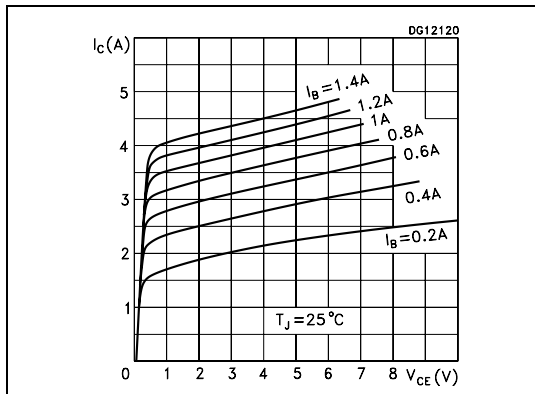

Figure 5. DC current gain

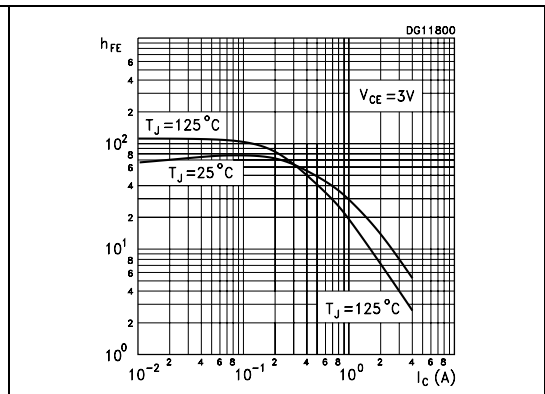

Figure 6. DC current gain

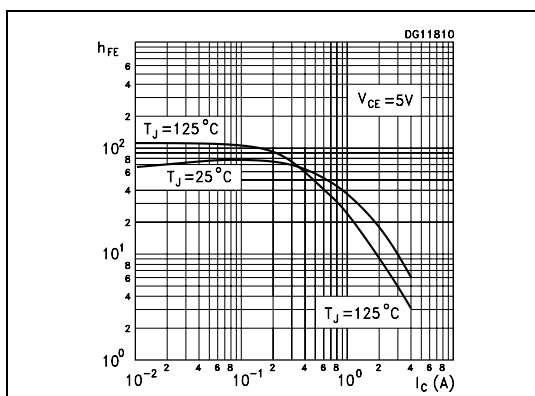
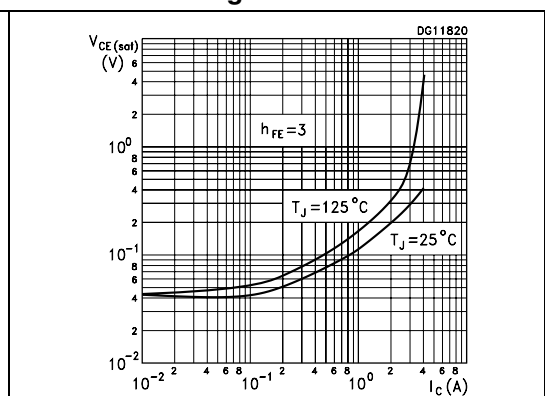
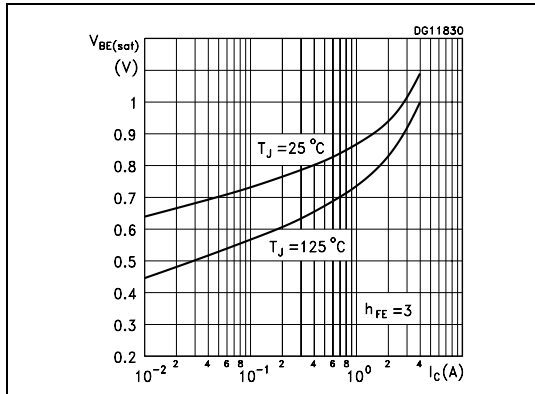

Figure 7. Collector - emitter saturation voltage



**Figure 8. Base-emitter saturation voltage**



**Figure 9. Resistive load switching on times ( $h_{FE} = 5$ )**

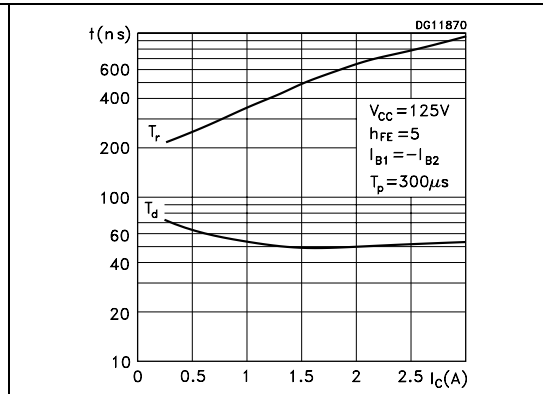

**Figure 10. Resistive load switching off times ( $h_{FE} = 5$ )**

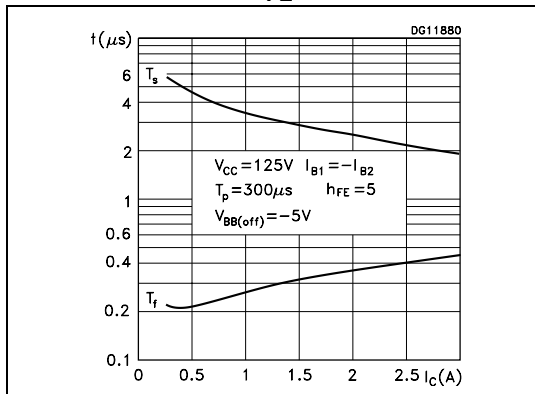

**Figure 11. Resistive load switching on times ( $h_{FE} = 10$ )**

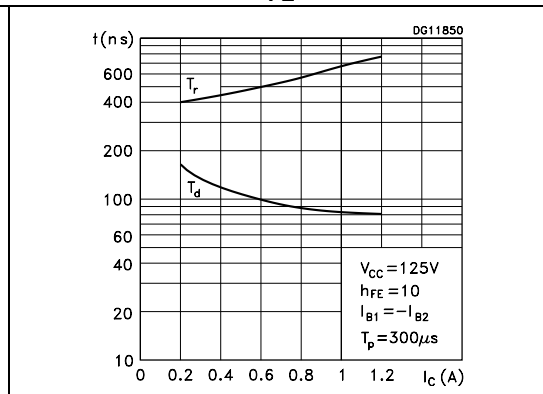

**Figure 12. Resistive load switching off times ( $h_{FE} = 10$ )**

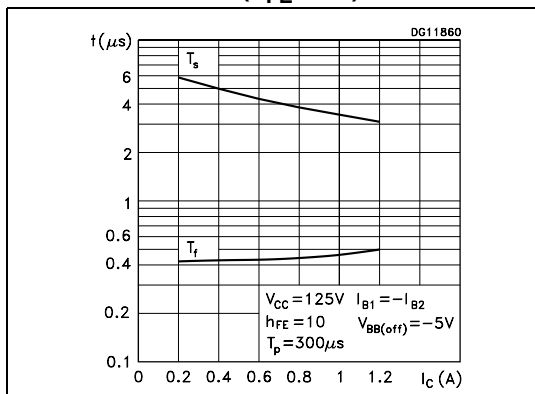

**Figure 13. Reverse biased SOA**

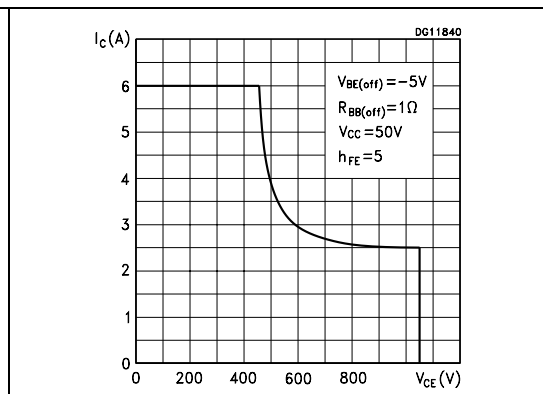

### 3 Test circuit

Figure 14. Energy rating test circuit

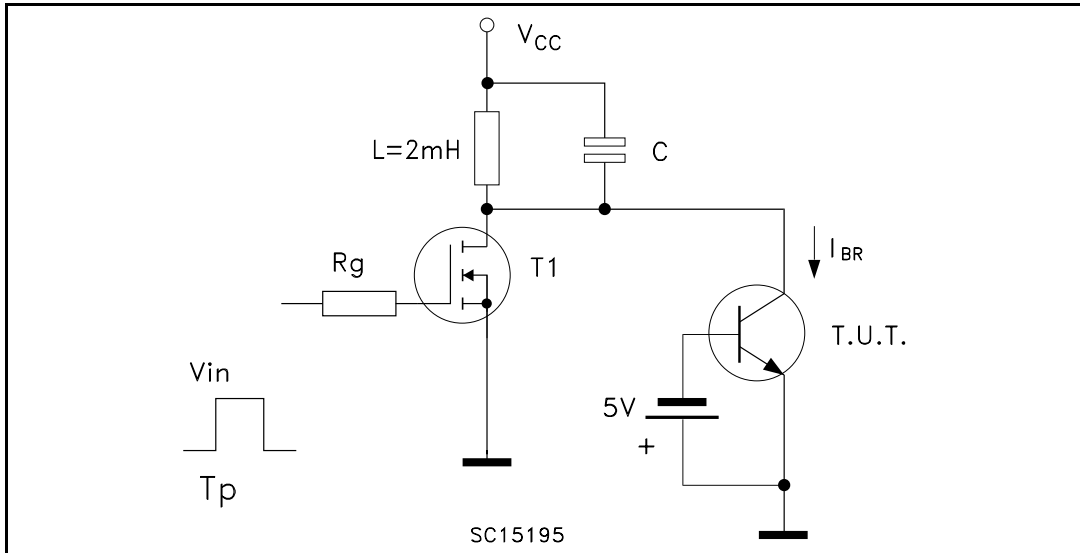
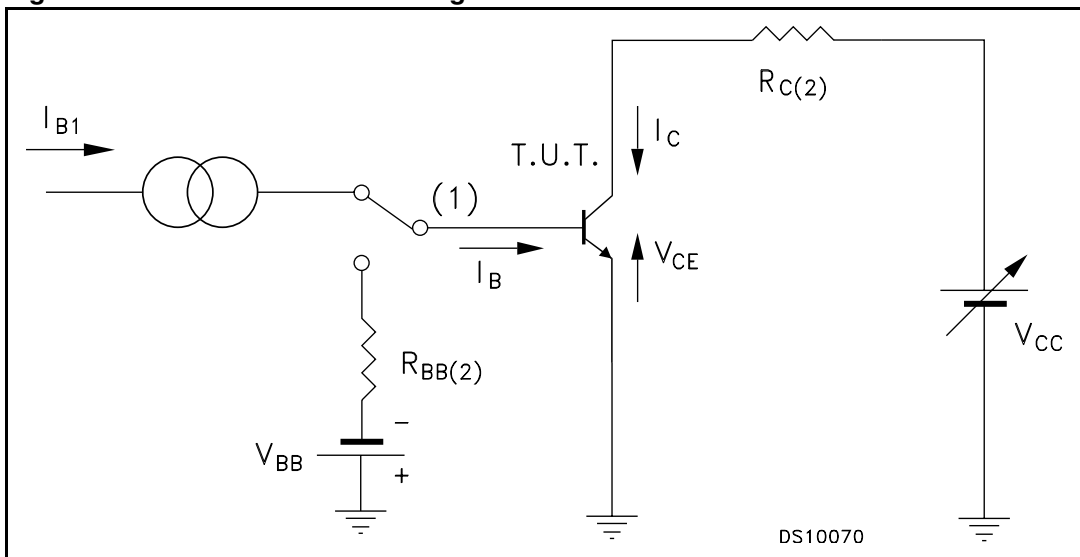

Figure 15. Resistive load switching test circuit



## 4 Package mechanical data

In order to meet environmental requirements, ST offers these devices in ECOPACK® packages. These packages have a Lead-free second level interconnect. The category of second level interconnect is marked on the package and on the inner box label, in compliance with JEDEC Standard JESD97. The maximum ratings related to soldering conditions are also marked on the inner box label. ECOPACK is an ST trademark. ECOPACK specifications are available at: [www.st.com](http://www.st.com)



**DPAK MECHANICAL DATA**

DIM.	mm.			inch		
	MIN.	TYP	MAX.	MIN.	TYP.	MAX.
A	2.2		2.4	0.086		0.094
A1	0.9		1.1	0.035		0.043
A2	0.03		0.23	0.001		0.009
B	0.64		0.9	0.025		0.035
b4	5.2		5.4	0.204		0.212
C	0.45		0.6	0.017		0.023
C2	0.48		0.6	0.019		0.023
D	6		6.2	0.236		0.244
D1		5.1			0.200	
E	6.4		6.6	0.252		0.260
E1		4.7			0.185	
e		2.28			0.090	
e1	4.4		4.6	0.173		0.181
H	9.35		10.1	0.368		0.397
L	1			0.039		
(L1)		2.8			0.110	
L2		0.8			0.031	
L4	0.6		1	0.023		0.039
R		0.2			0.008	
V2	0°		8°	0°		8°

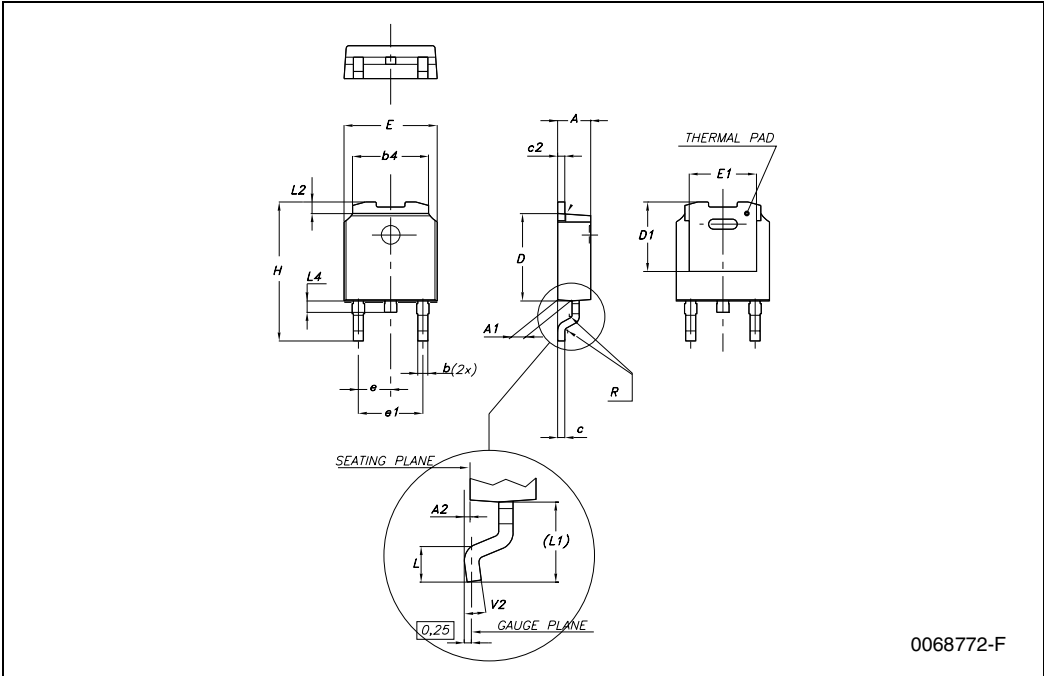

# 5 Packaging mechanical data

## DPAK FOOTPRINT

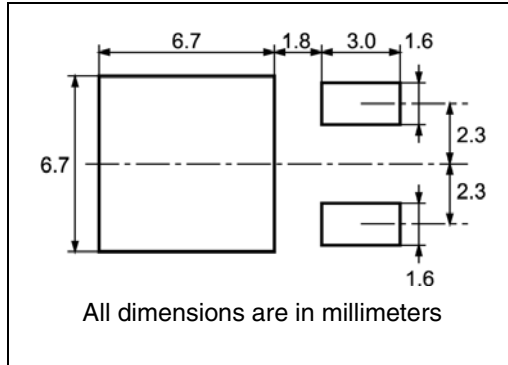

## TAPE AND REEL SHIPMENT

DIM.	mm		inch	
	MIN.	MAX.	MIN.	MAX.
A		330		12.992
B	1.5		0.059	
C	12.8	13.2	0.504	0.520
D	20.2		0.795	
G	16.4	18.4	0.645	0.724
N	50		1.968	
T		22.4		0.881

BASE QTY	BULK QTY
2500	2500

DIM.	mm		inch	
	MIN.	MAX.	MIN.	MAX.
A0	6.8	7	0.267	0.275
B0	10.4	10.6	0.409	0.417
B1		12.1		0.476
D	1.5	1.6	0.059	0.063
D1	1.5		0.059	
E	1.65	1.85	0.065	0.073
F	7.4	7.6	0.291	0.299
K0	2.55	2.75	0.100	0.108
P0	3.9	4.1	0.153	0.161
P1	7.9	8.1	0.311	0.319
P2	1.9	2.1	0.075	0.082
R	40		1.574	
W	15.7	16.3	0.618	0.641

## 6 Revision history

**Table 5. Document revision history**

Date	Revision	Changes
09-Aug-2007	1	First release.

**Please Read Carefully:**

Information in this document is provided solely in connection with ST products. STMicroelectronics NV and its subsidiaries ("ST") reserve the right to make changes, corrections, modifications or improvements, to this document, and the products and services described herein at any time, without notice.

All ST products are sold pursuant to ST's terms and conditions of sale.

Purchasers are solely responsible for the choice, selection and use of the ST products and services described herein, and ST assumes no liability whatsoever relating to the choice, selection or use of the ST products and services described herein.

No license, express or implied, by estoppel or otherwise, to any intellectual property rights is granted under this document. If any part of this document refers to any third party products or services it shall not be deemed a license grant by ST for the use of such third party products or services, or any intellectual property contained therein or considered as a warranty covering the use in any manner whatsoever of such third party products or services or any intellectual property contained therein.

**UNLESS OTHERWISE SET FORTH IN ST'S TERMS AND CONDITIONS OF SALE ST DISCLAIMS ANY EXPRESS OR IMPLIED WARRANTY WITH RESPECT TO THE USE AND/OR SALE OF ST PRODUCTS INCLUDING WITHOUT LIMITATION IMPLIED WARRANTIES OF MERCHANTABILITY, FITNESS FOR A PARTICULAR PURPOSE (AND THEIR EQUIVALENTS UNDER THE LAWS OF ANY JURISDICTION), OR INFRINGEMENT OF ANY PATENT, COPYRIGHT OR OTHER INTELLECTUAL PROPERTY RIGHT.**

**UNLESS EXPRESSLY APPROVED IN WRITING BY AN AUTHORIZED REPRESENTATIVE OF ST, ST PRODUCTS ARE NOT RECOMMENDED, AUTHORIZED OR WARRANTED FOR USE IN MILITARY, AIR CRAFT, SPACE, LIFE SAVING, OR LIFE SUSTAINING APPLICATIONS, NOR IN PRODUCTS OR SYSTEMS, WHERE FAILURE OR MALFUNCTION MAY RESULT IN PERSONAL INJURY, DEATH, OR SEVERE PROPERTY OR ENVIRONMENTAL DAMAGE. ST PRODUCTS WHICH ARE NOT SPECIFIED AS "AUTOMOTIVE GRADE" MAY ONLY BE USED IN AUTOMOTIVE APPLICATIONS AT USER'S OWN RISK.**

Resale of ST products with provisions different from the statements and/or technical features set forth in this document shall immediately void any warranty granted by ST for the ST product or service described herein and shall not create or extend in any manner whatsoever, any liability of ST.

ST and the ST logo are trademarks or registered trademarks of ST in various countries.

Information in this document supersedes and replaces all information previously supplied.

The ST logo is a registered trademark of STMicroelectronics. All other names are the property of their respective owners.

© 2007 STMicroelectronics - All rights reserved

STMicroelectronics group of companies

Australia - Belgium - Brazil - Canada - China - Czech Republic - Finland - France - Germany - Hong Kong - India - Israel - Italy - Japan - Malaysia - Malta - Morocco - Singapore - Spain - Sweden - Switzerland - United Kingdom - United States of America

[www.st.com](http://www.st.com)

# Mouser Electronics

Authorized Distributor

Click to View Pricing, Inventory, Delivery & Lifecycle Information:

[STMicroelectronics:](#)

[BULD742CT4](#)