

THIS DRAWING IS UNPUBLISHED. RELEASED FOR PUBLICATION 20  
COPYRIGHT 20 Y ALL RIGHTS RESERVED.

LOC H DIST -

REVISIONS					
P	LTR	DESCRIPTION	DATE	DWN	APVD
	G1	Adhesive tape width changed back to 6 mm	05FEB2016	SS	PS

REFERENCE MATING INTERFACE PATTERN:  
1,27 STAGGERED PITCH x 1,5 ROW-DISTANCE.

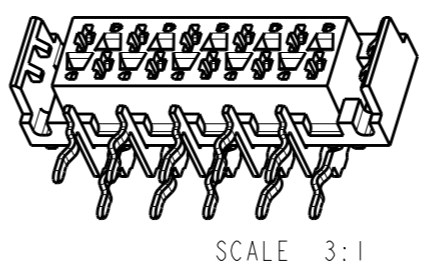
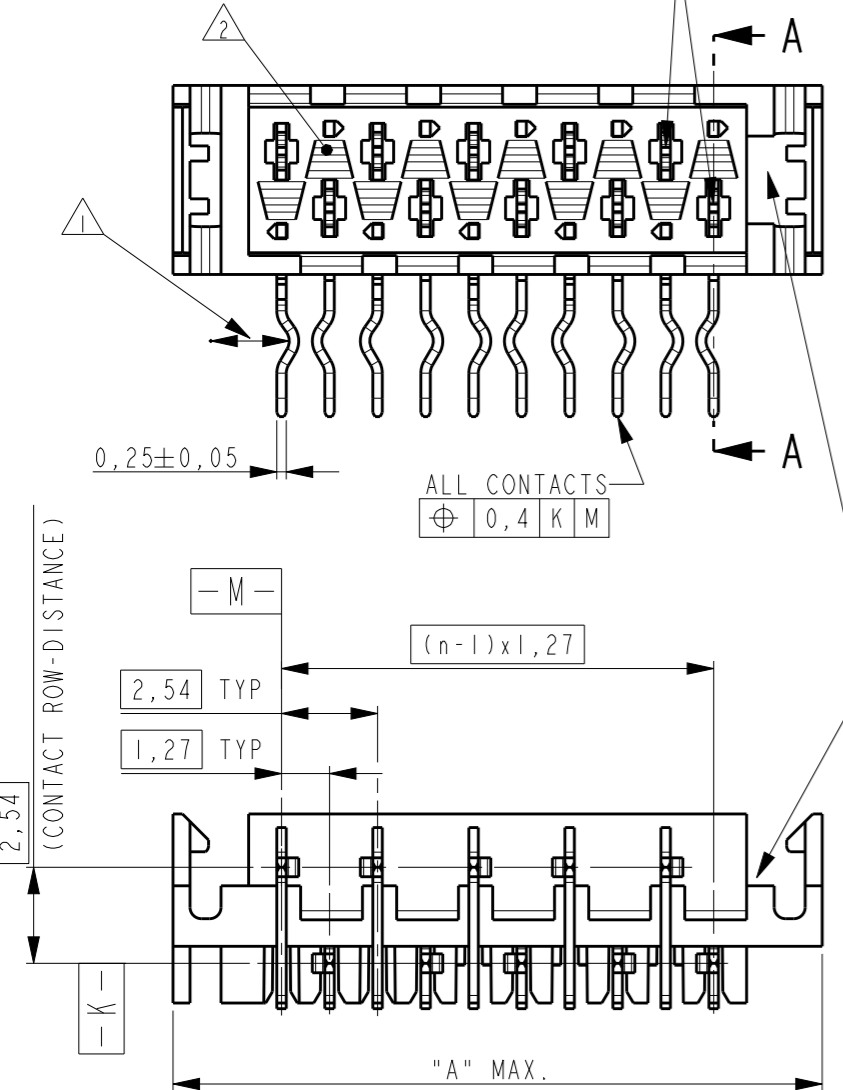

POLARISATION SLOT

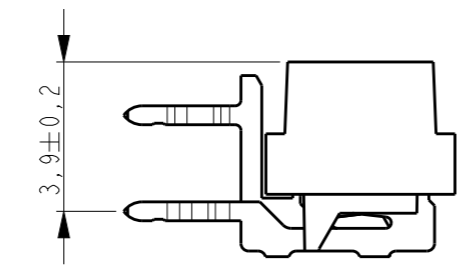

NOTES:

- 1 IN EACH ROW, DIRECTION OF KINKS STARTS RANDOM. IN EACH ROW, SEQUENTIAL CONTACTS HAVE OPPOSITE KINK DIRECTIONS.
- 2 CORING-OUTS FOR MANUFACTURING PURPOSE ONLY. SHAPE MAY VARY, BUT IS NOT FUNCTIONAL FOR THE APPLICATION.
- 3 SHOWN IS A 10 POSITION CONNECTOR.
- 4 THIS AREA IS RESERVED FOR CONTACTS.

PART NUMBER	NR. OF POS "n"	"A" MAX
338070-4	4	9,7
338070-6	6	12,2
338070-8	8	14,7
1-338070-0	10	17,3
1-338070-2	12	19,8
1-338070-4	14	22,4
1-338070-6	16	24,9
1-338070-8	18	27,4
2-338070-0	20	30,0

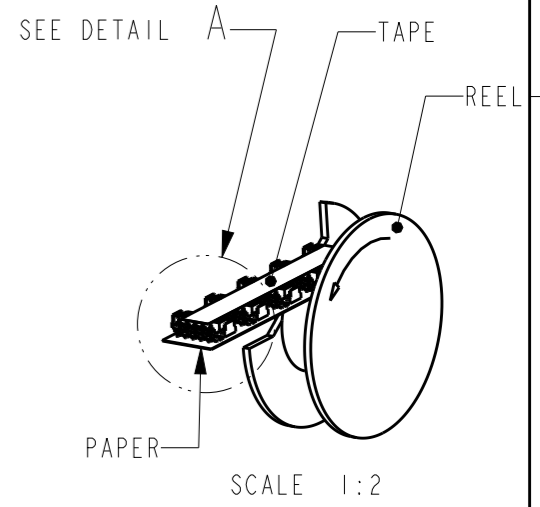
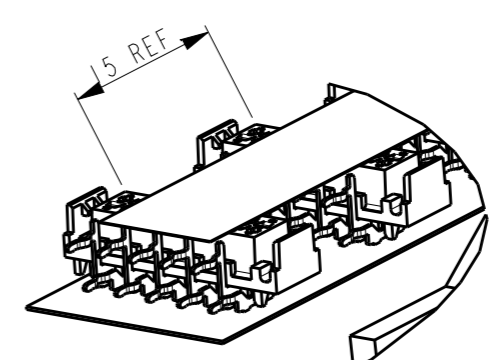

REEL PACKAGING DEREELING DIRECTION AND CONNECTOR POSITION. QUANTITY 2500 CONNECTORS PER REEL FOR ALL PART NUMBER.

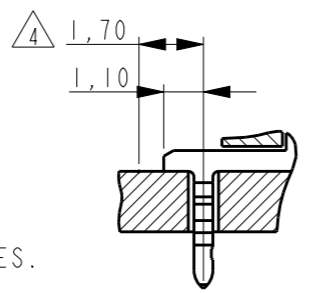
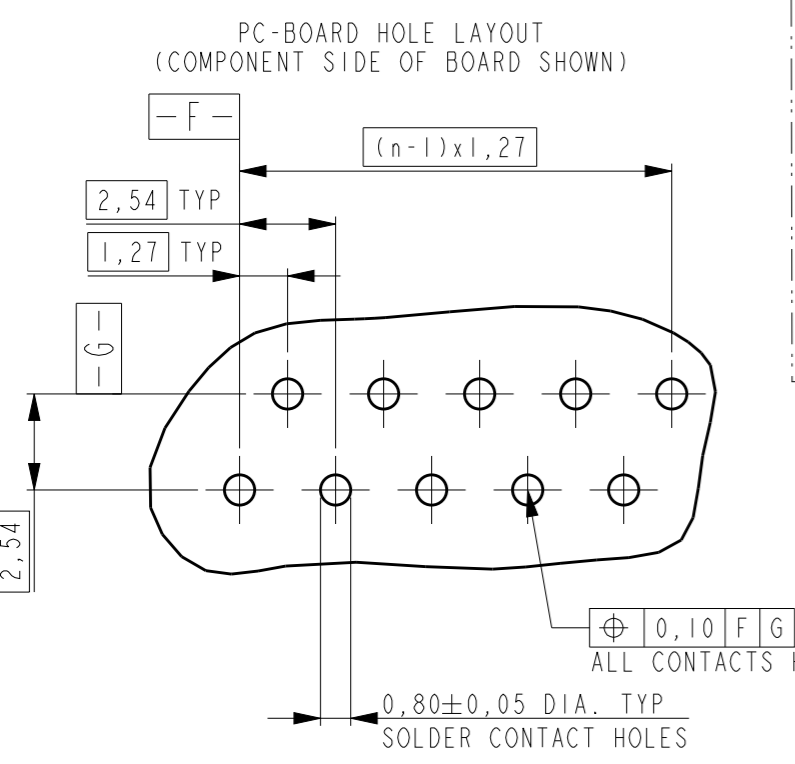

THIS DRAWING IS A CONTROLLED DOCUMENT.

DIMENSIONS:	TOLERANCES UNLESS OTHERWISE SPECIFIED:
mm	
	0 PLC $\pm$
	1 PLC $\pm$
	2 PLC $\pm$
	3 PLC $\pm$
	4 PLC $\pm$
	ANGLES $\pm 1^\circ$
MATERIAL	FINISH

2 HOUSING	G.F. POLYESTER PBT	RED
1 FEMALE CONTACT	PHOSPHOR BRONZE	TIN OVER NICKEL
ITEM NO.	DESCRIPTION	MATERIAL
DWN 03-JUN-96	DENNIS KESSLER	
CHK	HUUB VAN DELFT	
APVD	ERIC IJLJENS	
PRODUCT SPEC	108-19052	
APPLICATION SPEC		
WEIGHT		
Customer Drawing	SCALE 5:1	SHEET 1 OF 1 REV G1



CONNECTOR, FEMALE-ON-BOARD, SIDE-ENTRY, THRU-HOLE, WITH LATCHES, Micro-MatCh

# Mouser Electronics

Authorized Distributor

Click to View Pricing, Inventory, Delivery & Lifecycle Information:

[TE Connectivity:](#)

[1-338070-4](#)