

0.5 Nm RPT5 3.9 Watts 3.9 W Part number made to order



- Torque rating of gearbox : 0.5 Nm, sintered metal gears
- Motors : nominal power 3 W, interference suppression for standard stocked products
- Speed range : 1 to 895 rpm
- Optional encoder built into the motor

Part numbers

	Type	Type	Voltage	Output speed (rpm)	Ratios (i)
82862006	3.9 W	828620/2	24 V	45	95,4

Specifications

Electrical characteristics

Motor	828600
Gearbox	810120 / 810122
Maximum permitted torque from gearmotor under continuous conditions for 1 million turns (Nm)	0,5
Axial load static (daN)	1
Radial load static (daN)	8
Max. output power (W)	3,9
Nominal output (W)	3
Gearbox case temperature rise (°C)	50
Weight (g)	160 / 170

Made to order products, available on request

Motors :

- other supply voltages
- motors with 2 ball bearings
- shaft lengths at front and/or rear
- connection by radial tags or leads
- specific interference suppression
- encoder : 5 pulses per revolution

Gearboxes :

- special shaft, no flat/length
- ball bearings
- special fixings
- other reduction ratios
- special lubrication

Dimensions (mm)

828620

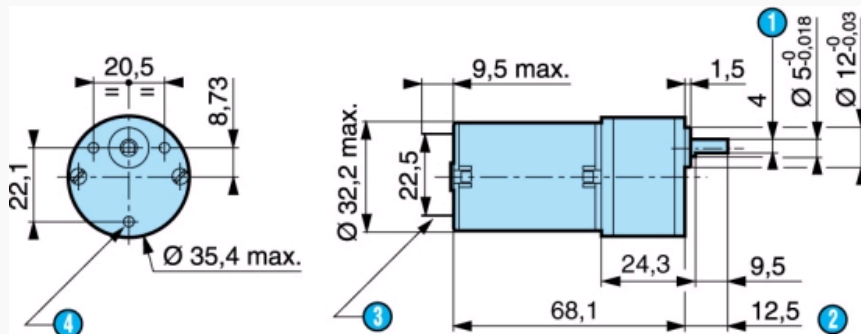

N°	Legend
①	4 across flats
②	Shaft pushed-in
③	2 standard tags NFC 20-120, series 2.8 x 0.5 mm
④	3 holes M3 depth 4.5 mm

Dimensions (mm)

828622

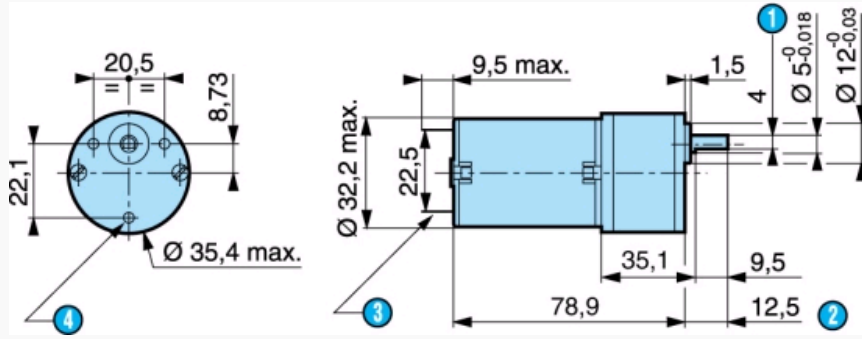

N°	Legend
1	4 across flats
2	Shaft pushed-in
3	2 standard tags NFC 20-120, series 2.8 x 0.5 mm
4	3 holes M3 depth 4.5 mm

Curves

Curve : torque/nominal speed

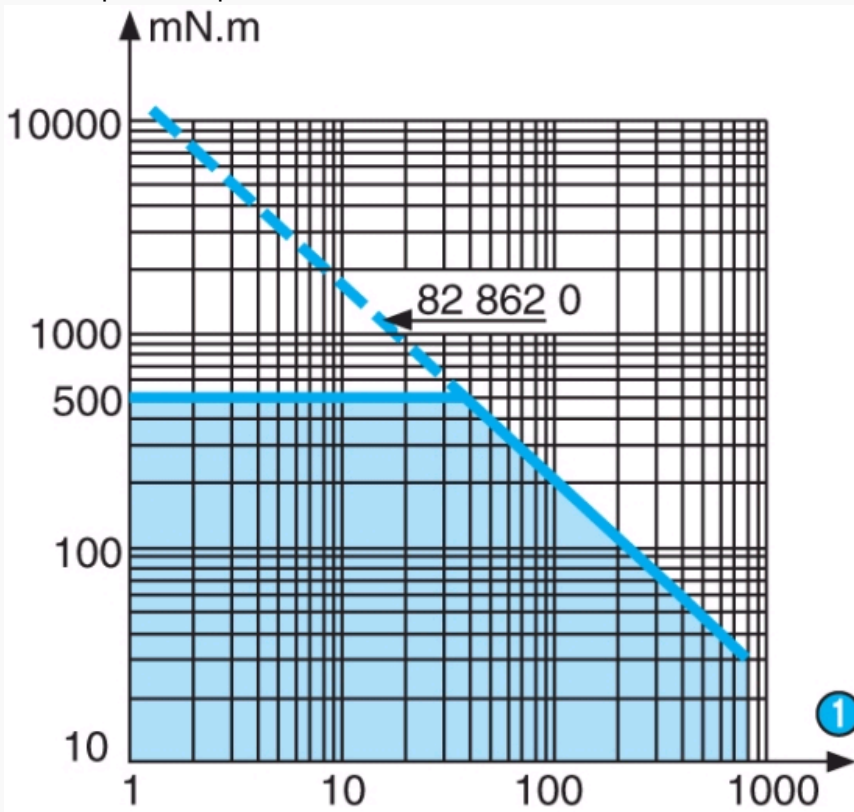

N°	Legend
1	rpm

Product adaptations



- Special supply voltage
- Lead output
- 1 or 5 pulse Hall effect encoder
- Special connectors
- Special shaft

- Special reduction ratio
- Special materials for pinion
- Special ball bearings
- Special adaptor plate
- EMC filter
- With shorter 1 W motor

Mouser Electronics

Authorized Distributor

Click to View Pricing, Inventory, Delivery & Lifecycle Information:

[Crouzet:](#)

[82862006](#)