

TPS54140EVM-429 1.5-A, SWIFT™ Regulator Evaluation Module

Contents

1	Introduction	2
2	Test Setup and Results	3
3	Board Layout.....	10
4	Schematic and Bill of Materials.....	12

List of Figures

1	TPS54140EVM-429 Efficiency	4
2	TPS54140EVM-429 Low Current Efficiency	5
3	TPS54140EVM-429 Load Regulation.....	5
4	TPS54140EVM-429 Line Regulation.....	6
5	TPS54140EVM-429 Transient Response	6
6	TPS54140EVM-429 Loop Response	7
7	TPS54140EVM-429 Output Ripple	7
8	TPS54140EVM-429 Input Ripple	8
9	TPS54140EVM-429 Start-Up Relative to V_{IN}	9
10	TPS54140EVM-429 Eco-mode™ Operation.....	9
11	TPS54140EVM-429 Top-Side Layout	10
12	TPS54140EVM-429 Bottom-Side Layout	11
13	TPS54140EVM-429 Top-Side Assembly.....	11
14	TPS54140EVM-429 Schematic	13

List of Tables

1	Input Voltage and Output Current Summary	2
2	TPS54140EVM-429 Performance Specification Summary.....	2
3	Output Voltages Available	3
4	EVM Connectors and Test Points	4
5	TPS54140EVM-429 Bill of Materials.....	14

1 Introduction

This user's guide contains background information for the TPS54140 as well as support documentation for the TPS54140EVM-429 evaluation module (HPA429). Also included are the performance specifications, the schematic, and the bill of materials for the TPS54140EVM-429.

1.1 Background

The TPS54140 dc/dc converter is designed to provide up to a 1.5 A output from an input voltage source of 3.5 V to 42 V. Rated input voltage and output current range for the evaluation module are given in [Table 1](#). This evaluation module is designed to demonstrate the small printed-circuit-board areas that may be achieved when designing with the TPS54140 regulator. The switching frequency is externally set at a nominal 500 kHz. The high-side MOSFET is incorporated inside the TPS54140 package along with the gate drive circuitry. The low drain-to-source on resistance of the MOSFET allows the TPS54140 to achieve high efficiencies and helps keep the junction temperature low at high output currents. The compensation components are external to the integrated circuit (IC), and an external divider allows for an adjustable output voltage. Additionally, the TPS54140 provides adjustable slow start and undervoltage lockout inputs. The absolute maximum input voltage is 42 V for the TPS54140EVM-429.

Table 1. Input Voltage and Output Current Summary

EVM	INPUT VOLTAGE RANGE	OUTPUT CURRENT RANGE
TPS54140EVM-429	$V_{IN} = 25 \text{ V to } 42 \text{ V}$	0 A to 1.5A

1.2 Performance Specification Summary

A summary of the TPS54140EVM-429 performance specifications is provided in [Table 2](#). Specifications are given for an input voltage of $V_{IN} = 34 \text{ V}$ and an output voltage of 3.3 V, unless otherwise specified. The TPS54140EVM-429 is designed and tested for $V_{IN} = 25 \text{ V to } 42 \text{ V}$. The ambient temperature is 25°C for all measurements, unless otherwise noted.

Table 2. TPS54140EVM-429 Performance Specification Summary

SPECIFICATION	TEST CONDITIONS	MIN	TYP	MAX	UNIT
V_{IN} voltage range		25	34	42	V
Output voltage set point			3.3		V
Output current range	$V_{IN} = 25 \text{ V to } 42 \text{ V}$	0		1.5	A
Line regulation	$I_O = 0.75 \text{ A}$, $V_{IN} = 25 \text{ V to } 42 \text{ V}$		$\pm 0.025\%$		
Load regulation	$V_{IN} = 34 \text{ V}$, $I_O = 0 \text{ A to } 1.5 \text{ A}$		$\pm 0.05\%$		
Load transient response	$I_O = 0.25 \text{ A to } 1.25 \text{ A}$	Voltage change		-55	mV
		Recovery time		1	ms
	$I_O = 1.25 \text{ A to } 0.25 \text{ A}$	Voltage change		60	mV
		Recovery time		1	ms
Loop bandwidth	$V_{IN} = 34 \text{ V}$, $I_O = 1.5 \text{ A}$		21		kHz
Phase margin	$V_{IN} = 34 \text{ V}$, $I_O = 1.5 \text{ A}$		62		°
Input ripple voltage	$I_O = 1.5 \text{ A}$		160		mV _{PP}
Output ripple voltage	$I_O = 1.5 \text{ A}$		5		mV _{PP}
Output rise time			4		ms
Operating frequency			500		kHz
Maximum efficiency	TPS54140EVM-429, $V_{IN} = 25 \text{ V}$, $I_O = 0.6 \text{ A}$		86%		

1.3 Modifications

These evaluation modules are designed to provide access to the features of the TPS54140. Some modifications can be made to this module.

1.3.1 Output Voltage Set Point

To change the output voltage of the EVM, it is necessary to change the value of resistor R_6 . Changing the value of R_6 can change the output voltage above 0.8 V. The value of R_6 for a specific output voltage can be calculated using [Equation 1](#).

$$R_6 = 10 \text{ k}\Omega \times \frac{(V_{\text{OUT}} - 0.8 \text{ V})}{0.8 \text{ V}} \quad (1)$$

[Table 3](#) lists the R_6 values for some common output voltages. Note that V_{IN} must be in a range so that the minimum on-time is greater than 130 ns, and the maximum duty cycle is less than 91%. The values given in [Table 3](#) are standard values, not the exact value calculated using [Equation 1](#).

Table 3. Output Voltages Available

Output Voltage (V)	R_6 Value (k Ω)
1.8	12.4
2.5	21.5
3.3	31.6
5	52.3

Be aware that changing the output voltage can affect the loop response. It may be necessary to modify the compensation components. See the datasheet for details.

2 Test Setup and Results

This section describes how to properly connect, set up, and use the TPS54140EVM-429 evaluation module. The section also includes test results typical for the evaluation module and covers efficiency, output voltage regulation, load transients, loop response, output ripple, input ripple, and start-up.

2.1 Input / Output Connections

The TPS54140EVM-429 is provided with input/output connectors and test points as shown in [Table 4](#). A power supply capable of supplying 1A must be connected to J1 through a pair of 20 AWG wires. The load must be connected to J4 through a pair of 20 AWG wires. The maximum load current capability must be 1.5 A. Wire lengths must be minimized to reduce losses in the wires. Test-point TP1 provides a place to monitor the V_{IN} input voltages with TP2 providing a convenient ground reference. TP9 is used to monitor the output voltage with TP10 as the ground reference.

Table 4. EVM Connectors and Test Points

Reference Designator	Function
J1	V_{IN} (see Table 1 for V_{IN} range)
J2	V_{OUT} , 3.3 V at 0.5 A maximum
TP1	V_{IN} test point at V_{IN} connector
TP2	GND test point at V_{IN}
TP3	EN test point. Connect EN to ground to disable, open to enable.
TP4	Slow start monitor test point
TP5	PWRGD test point
TP6	PH test point
TP7	Output voltage test point at voltage divider. Used for loop response measurements.
TP8	Test point between voltage divider network and output. Used for loop response measurements.
TP9	Output voltage test point at OUT connector
TP10	GND test point at OUT connector

2.2 Efficiency

The efficiency of this EVM peaks at a load current of about 0.5 A - 1 A and then decreases as the load current increases towards full load. Figure 1 shows the efficiency for the TPS54140EVM-429 at an ambient temperature of 25°C.

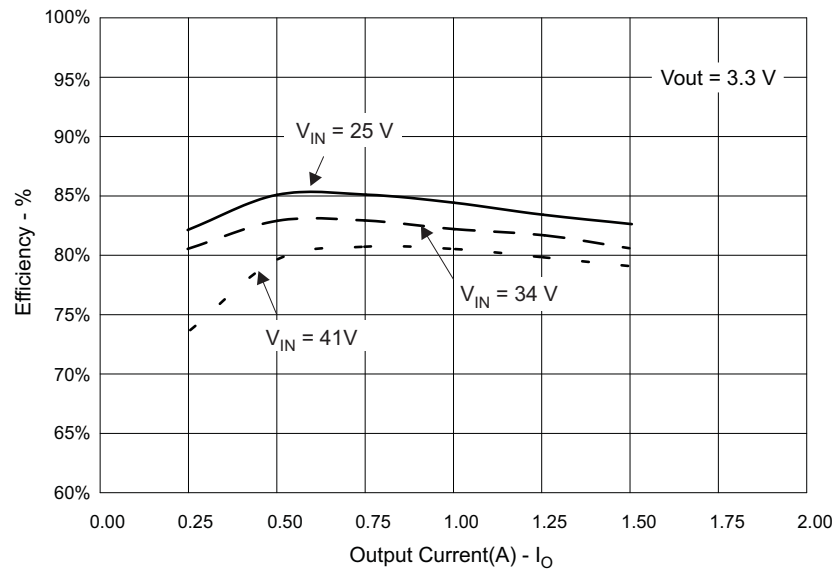

Figure 1. TPS54140EVM-429 Efficiency

Figure 2 shows the efficiency for the TPS54140EVM-429 at lower output currents between 0.02 A and 0.25 A at an ambient temperature of 25°C.

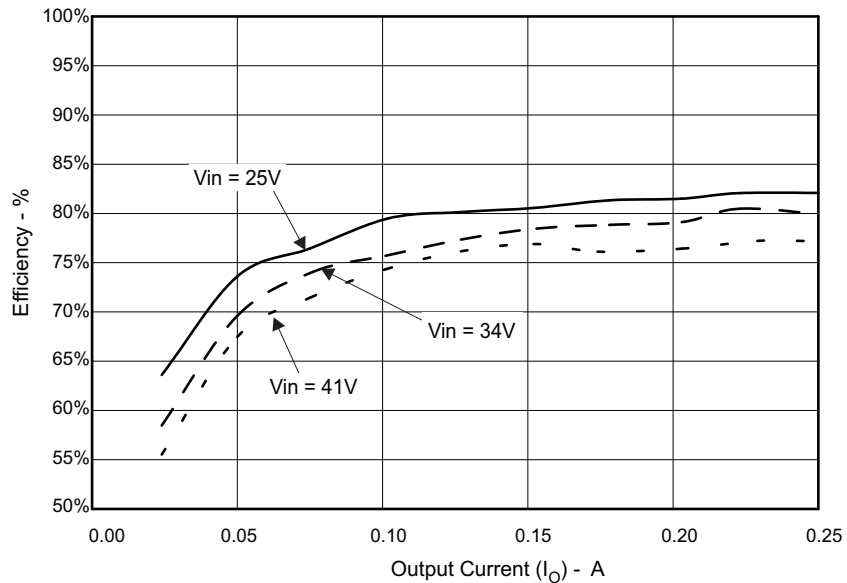

Figure 2. TPS54140EVM-429 Low Current Efficiency

The efficiency may be lower at higher ambient temperatures, due to temperature variation in the drain-to-source resistance of the internal MOSFET.

2.3 Output Voltage Load Regulation

The load regulation for the TPS54140EVM-429 is shown in Figure 3.

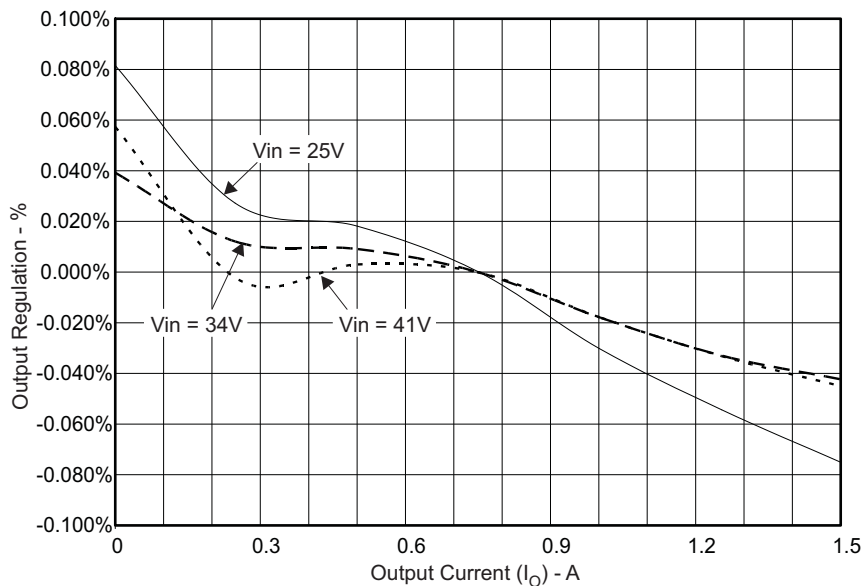

Figure 3. TPS54140EVM-429 Load Regulation

Measurements are given for an ambient temperature of 25°C.

2.4 Output Voltage Line Regulation

The line regulation for the TPS54140EVM-429 is shown in Figure 4.

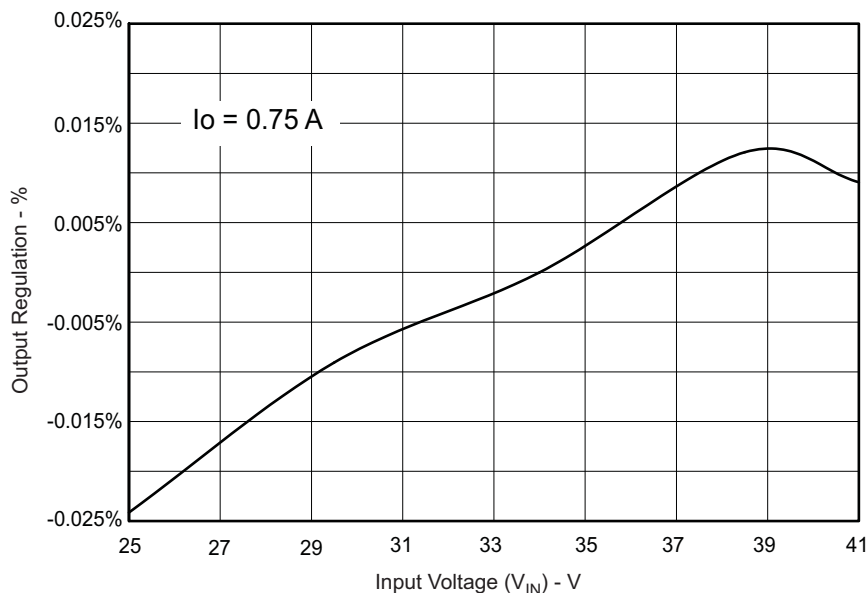

Figure 4. TPS54140EVM-429 Line Regulation

2.5 Load Transients

The TPS54140EVM-429 response to load transients is shown in Figure 5. The current step is from 0.25 A to 1.25 A. The input voltage is 34 V. Total peak-to-peak voltage variation is as shown, including ripple and noise on the output.

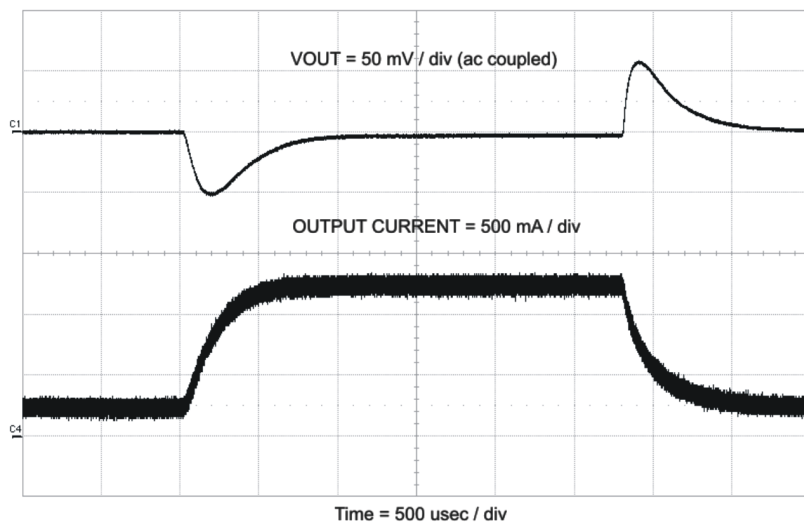

Figure 5. TPS54140EVM-429 Transient Response

2.6 Loop Characteristics

The TPS54140EVM-429 loop-response characteristics are shown in Figure 6 . Gain and phase plots are shown for V_{IN} voltage of 34V. Load current for the measurement is 1.5 A.

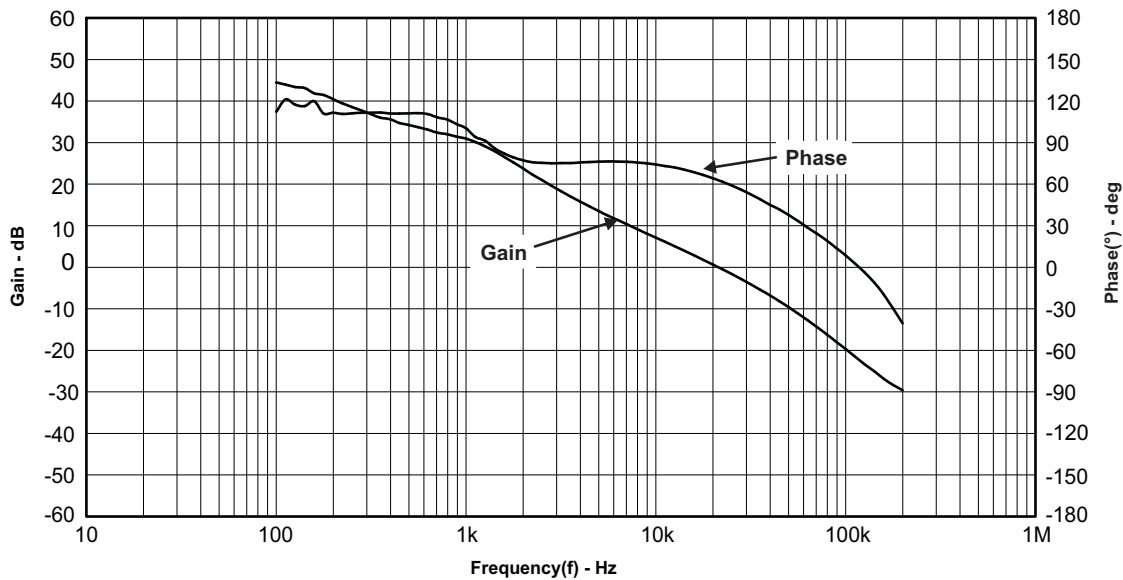

Figure 6. TPS54140EVM-429 Loop Response

2.7 Output Voltage Ripple

The TPS54140EVM-429 output voltage ripple is shown in Figure 7 . The output current is the rated full load of 1.5 A and $V_{IN} = 34$ V. The ripple voltage is measured directly across the output capacitors.

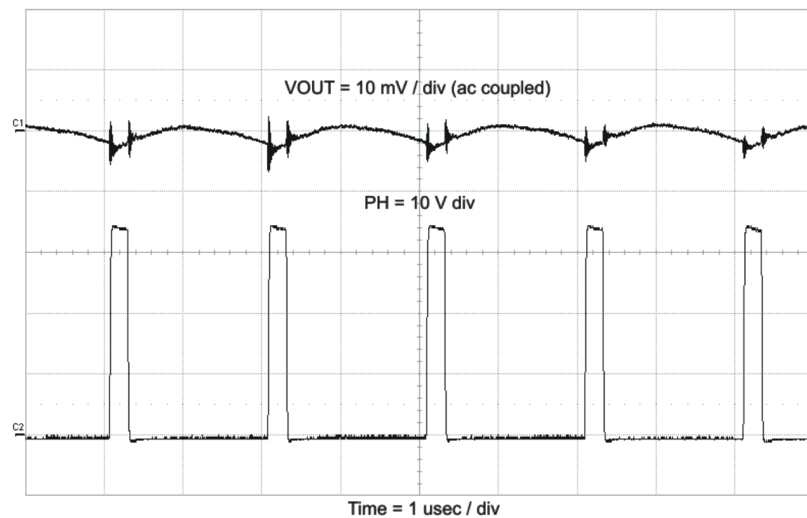

Figure 7. TPS54140EVM-429 Output Ripple

2.8 Input Voltage Ripple

The TPS54140EVM-429 input voltage ripple is shown in [Figure 8](#). The output current is the rated full load of 1.5 A and $V_{IN} = 34$ V. The ripple voltage is measured directly across the input capacitors.

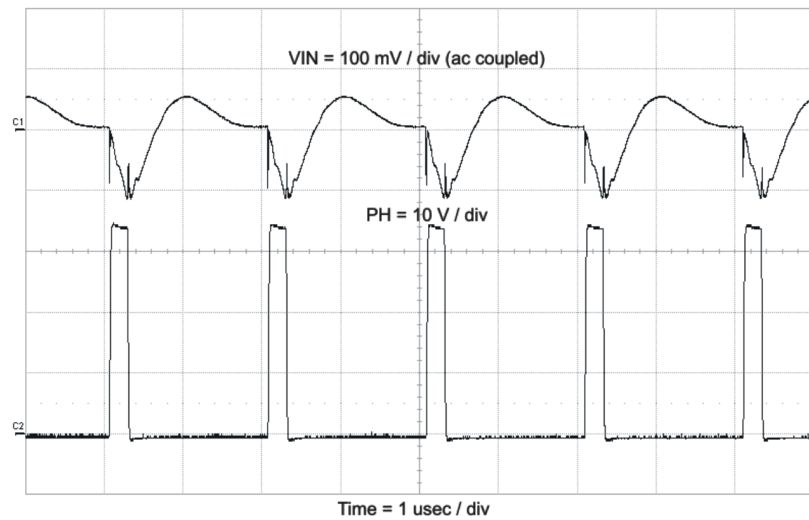

Figure 8. TPS54140EVM-429 Input Ripple

2.9 Powering Up

The start-up waveforms are shown in [Figure 9](#). In [Figure 9](#), the top trace shows V_{OUT} , and the bottom trace shows V_{IN} . The input voltage is initially applied, and when the input reaches the undervoltage lockout threshold, the start-up sequence begins and the output ramps up at the externally set rate toward the value of 3.3 V. The input voltage for this waveform is 34 V with a 1.5 A load.

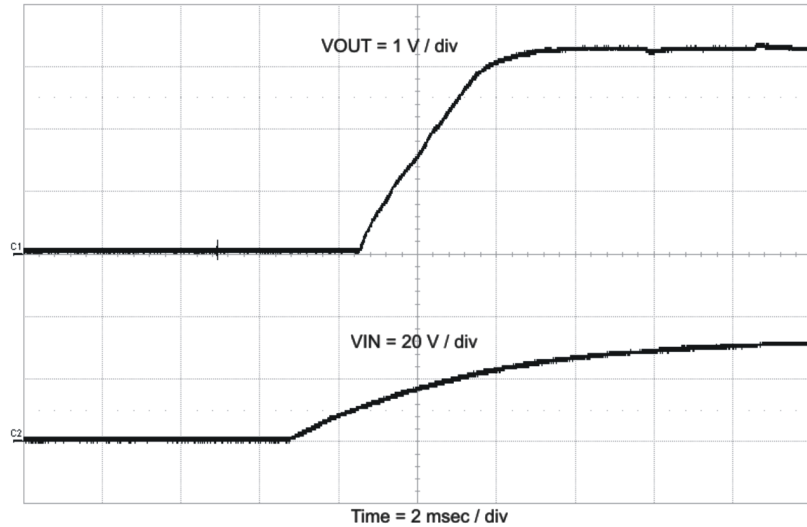

Figure 9. TPS54140EVM-429 Start-Up Relative to V_{IN}

2.10 Eco-mode™ Operation

At light load currents, the TPS54140 is designed to operate in pulse skipping Eco-mode™. When the COMP pin lowers to 500 mV typical, the device enters Eco-mode™ operation.

[Figure 10](#) shows Eco-mode operation, channel 1(C1) shows the output voltage while channel 2(C2) shows the switching node (PH).

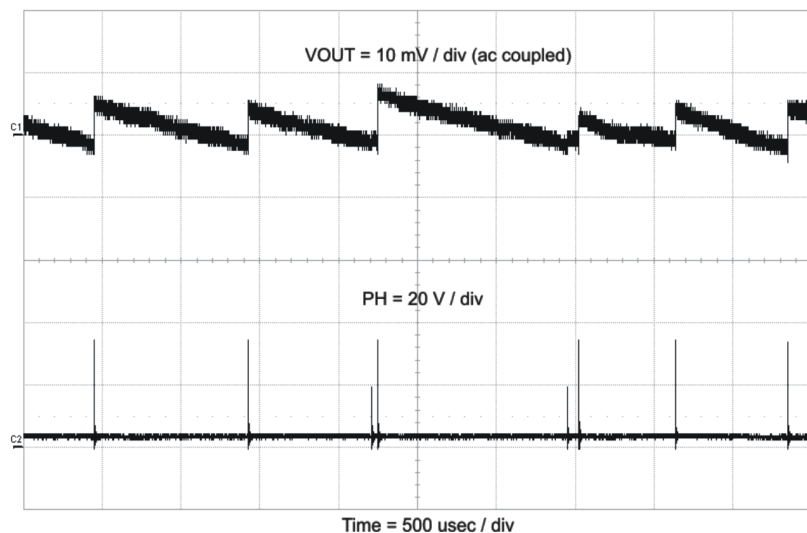

Figure 10. TPS54140EVM-429 Eco-mode™ Operation

3 Board Layout

This section provides a description of the TPS54140EVM-429, board layout, and layer illustrations.

3.1 Layout

The board layout for the TPS54140EVM-429 is shown in [Figure 11](#) through [Figure 13](#). The topside layer of the EVM is laid out in a manner typical of a user application. The top and bottom layers are 2-oz. copper.

The top layer contains the main power traces for V_{IN} , V_{OUT} , and V_{PHASE} . Also on the top layer are connections for the remaining pins of the TPS54140 and a large area filled with ground. The bottom layer contains ground and a signal route for the BOOT capacitor. The top and bottom and internal ground traces are connected with multiple vias placed around the board including ten vias directly under the TPS54140 device to provide a thermal path from the top-side ground plane to the bottom-side ground plane.

The input decoupling capacitors (C2, and C3) and bootstrap capacitor (C6) are all located as close to the IC as possible. In addition, the voltage set-point resistor divider components are also kept close to the IC. The voltage divider network ties to the output voltage at the point of regulation, the copper V_{OUT} trace past the output capacitor (C5). For the TPS54140, an additional input bulk capacitor may be required (C1), depending on the EVM connection to the input supply.

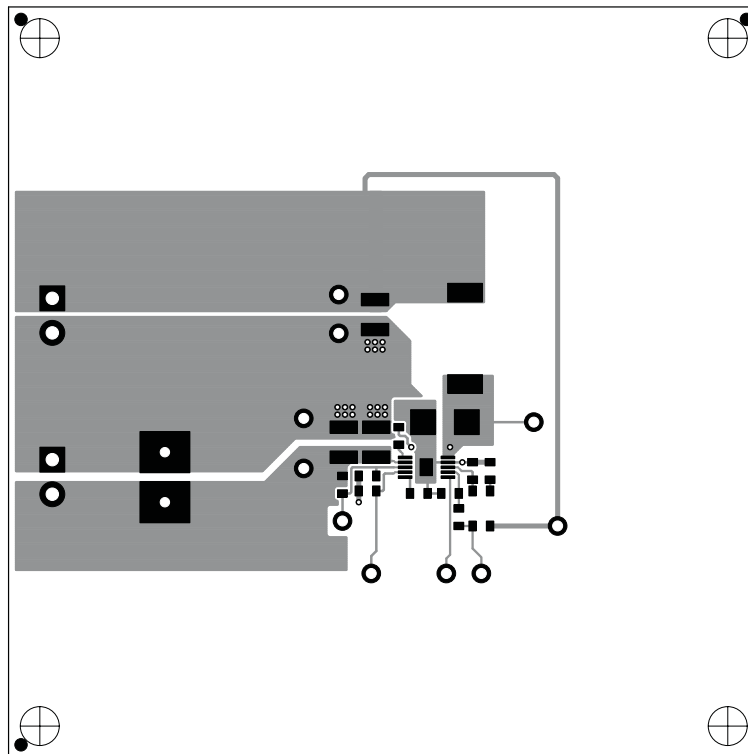

Figure 11. TPS54140EVM-429 Top-Side Layout

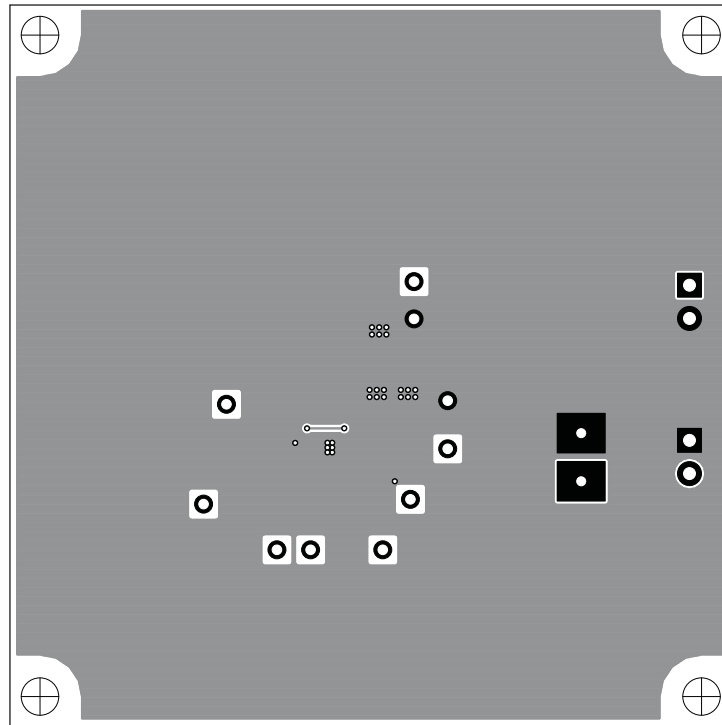

Figure 12. TPS54140EVM-429 Bottom-Side Layout

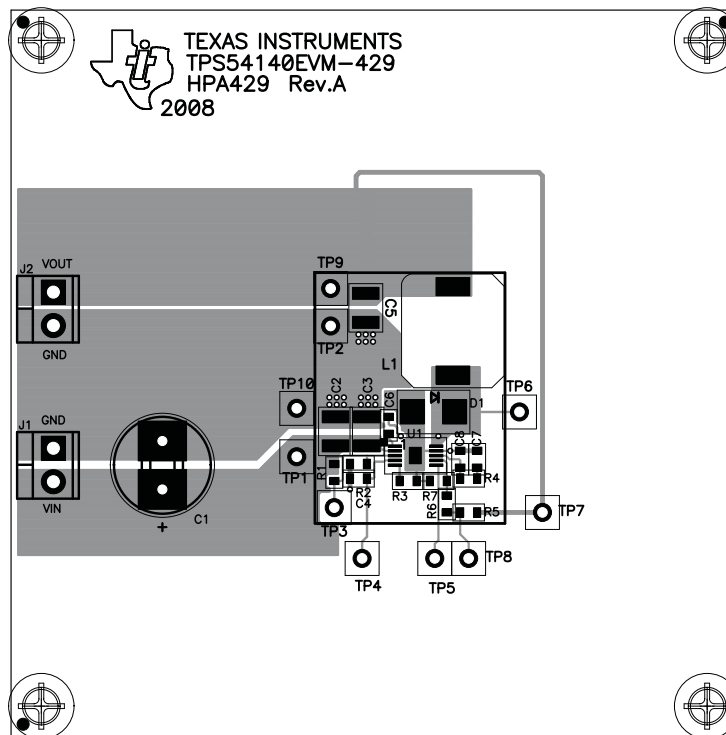

Figure 13. TPS54140EVM-429 Top-Side Assembly

3.2 Estimated Circuit Area

The estimated printed circuit board area for the components used in this design is 0.55 in². This area does not include test point or connectors.

4 Schematic and Bill of Materials

This section presents the TPS54140EVM-429 schematic and bill of materials.

4.1 Schematic

Figure 14 is the schematic for the TPS54140EVM-429.

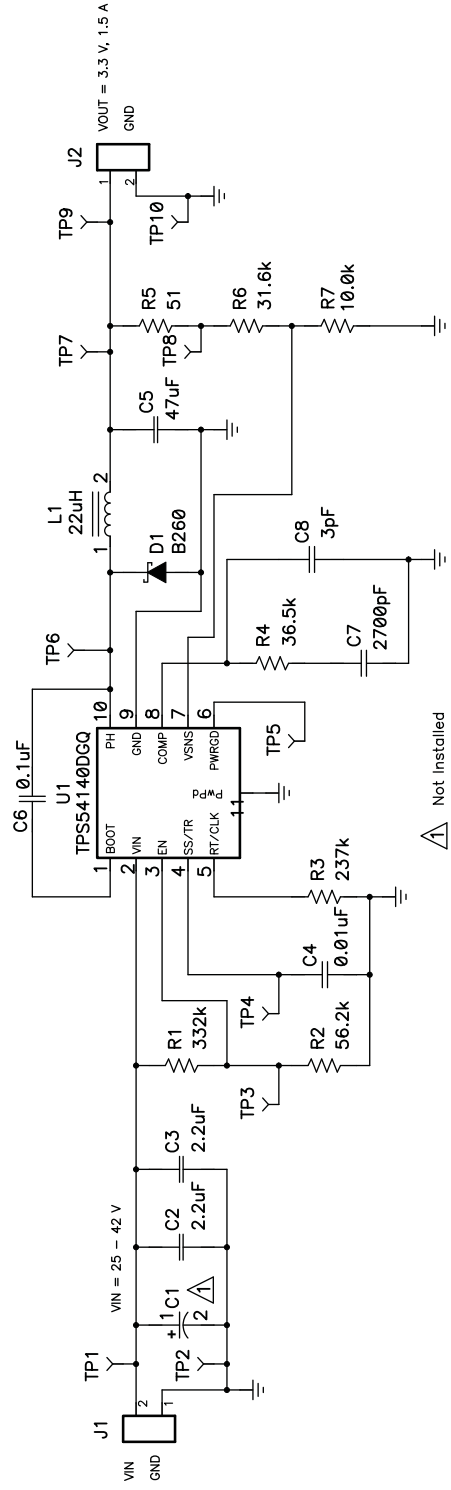

Figure 14. TPS54140EVM-429 Schematic

4.2 Bill of Materials

Table 5 presents the bill of materials for the TPS54140EVM-429.

Table 5. TPS54140EVM-429 Bill of Materials

Count	RefDes	Value	Description	Size	Part Number	MFR
0	C1	Open	Capacitor, multi pattern, SM 1210 to E case + F THole	Multi sizes	Engineering Only	Std
2	C2, C3	2.2uF	2.2uF Capacitor, Ceramic, 100V, X7R, 10%	1210	Std	Std
1	C4	0.01uF	Capacitor, Ceramic, 25V, X5R, 20%	0603	Std	Std
1	C5	47uF	Capacitor, Ceramic, 10V, X5R, 20%	1210	Std	Std
1	C6	0.1uF	Capacitor, Ceramic, 25V, X5R, 10% "	0603	Std	Std
1	C7	2700pF	Capacitor, Ceramic, 10V, X5R, 10%	0603	Std	Std
1	C8	3pF	Capacitor, Ceramic, 50V, NPO, ±25pF	0603	Std	Std
1	D1	B260	Diode, Schottky, 2A, 60V	SMB	B260-13-F	Motorola
2	J1, J2	ED1514	Terminal Block, 2-pin, 6-A, 3.5mm	0.27" x 0.25"	ED1514	OST
1	L1	22uH	Inductor, SMT, 2.36A, 61milliohm	0.402 x 0.394 inch	MSS1048-223MLB	Coilcraft
1	R1	332k	Resistor, Chip, 1/16W, 1%	0603	Std	Std
1	R2	56.2k	Resistor, Chip, 1/16W, 1%	0603	Std	Std
1	R3	237k	Resistor, Chip, 1/16W, 1%	0603	Std	Std
1	R4	36.5k	Resistor, Chip, 1/16W, 1%	0603	Std	Std
1	R5	51	Resistor, Chip, 1/16W, 1%	0603	Std	Std
1	R6	31.6k	Resistor, Chip, 1/16W, 1%	0603	Std	Std
1	R7	10.0k	Resistor, Chip, 1/16W, 1%	0603	Std	Std
7	TP1, TP3, TP4, TP6, TP7 - TP9	5000	Test Point, Red, Thru Hole Color Keyed	0.100 x 0.100 inch	5000	Keystone
3	TP2, TP5, TP10	5001	Test Point, Black, Thru Hole Color Keyed	0.100 x 0.100 inch	5001	Keystone
1	U1	TPS54140D GQ	IC, DC-DC Converter, 3.3V, 1.5A	MSOP-10	TP54160DGQ	TI
1			PCB, 3.0" x 3.0		HPA429	Any

EVALUATION BOARD/KIT IMPORTANT NOTICE

Texas Instruments (TI) provides the enclosed product(s) under the following conditions:

This evaluation board/kit is intended for use for **ENGINEERING DEVELOPMENT, DEMONSTRATION, OR EVALUATION PURPOSES ONLY** and is not considered by TI to be a finished end-product fit for general consumer use. Persons handling the product(s) must have electronics training and observe good engineering practice standards. As such, the goods being provided are not intended to be complete in terms of required design-, marketing-, and/or manufacturing-related protective considerations, including product safety and environmental measures typically found in end products that incorporate such semiconductor components or circuit boards. This evaluation board/kit does not fall within the scope of the European Union directives regarding electromagnetic compatibility, restricted substances (RoHS), recycling (WEEE), FCC, CE or UL, and therefore may not meet the technical requirements of these directives or other related directives.

Should this evaluation board/kit not meet the specifications indicated in the User's Guide, the board/kit may be returned within 30 days from the date of delivery for a full refund. **THE FOREGOING WARRANTY IS THE EXCLUSIVE WARRANTY MADE BY SELLER TO BUYER AND IS IN LIEU OF ALL OTHER WARRANTIES, EXPRESSED, IMPLIED, OR STATUTORY, INCLUDING ANY WARRANTY OF MERCHANTABILITY OR FITNESS FOR ANY PARTICULAR PURPOSE.**

The user assumes all responsibility and liability for proper and safe handling of the goods. Further, the user indemnifies TI from all claims arising from the handling or use of the goods. Due to the open construction of the product, it is the user's responsibility to take any and all appropriate precautions with regard to electrostatic discharge.

EXCEPT TO THE EXTENT OF THE INDEMNITY SET FORTH ABOVE, NEITHER PARTY SHALL BE LIABLE TO THE OTHER FOR ANY INDIRECT, SPECIAL, INCIDENTAL, OR CONSEQUENTIAL DAMAGES.

TI currently deals with a variety of customers for products, and therefore our arrangement with the user **is not exclusive.**

TI assumes **no liability for applications assistance, customer product design, software performance, or infringement of patents or services described herein.**

Please read the User's Guide and, specifically, the Warnings and Restrictions notice in the User's Guide prior to handling the product. This notice contains important safety information about temperatures and voltages. For additional information on TI's environmental and/or safety programs, please contact the TI application engineer or visit www.ti.com/esh.

No license is granted under any patent right or other intellectual property right of TI covering or relating to any machine, process, or combination in which such TI products or services might be or are used.

FCC Warning

This evaluation board/kit is intended for use for **ENGINEERING DEVELOPMENT, DEMONSTRATION, OR EVALUATION PURPOSES ONLY** and is not considered by TI to be a finished end-product fit for general consumer use. It generates, uses, and can radiate radio frequency energy and has not been tested for compliance with the limits of computing devices pursuant to part 15 of FCC rules, which are designed to provide reasonable protection against radio frequency interference. Operation of this equipment in other environments may cause interference with radio communications, in which case the user at his own expense will be required to take whatever measures may be required to correct this interference.

EVM WARNINGS AND RESTRICTIONS

It is important to operate this EVM within the input voltage range and the output current range specified in Table 1.

Exceeding the specified input range may cause unexpected operation and/or irreversible damage to the EVM. If there are questions concerning the input range, please contact a TI field representative prior to connecting the input power.

Applying loads outside of the specified output range may result in unintended operation and/or possible permanent damage to the EVM. Please consult the EVM User's Guide prior to connecting any load to the EVM output. If there is uncertainty as to the load specification, please contact a TI field representative.

During normal operation, some circuit components may have case temperatures greater than 55°C. The EVM is designed to operate properly with certain components above 60°C as long as the input and output ranges are maintained. These components include but are not limited to linear regulators, switching transistors, pass transistors, and current sense resistors. These types of devices can be identified using the EVM schematic located in the EVM User's Guide. When placing measurement probes near these devices during operation, please be aware that these devices may be very warm to the touch.

Mailing Address: Texas Instruments, Post Office Box 655303, Dallas, Texas 75265
Copyright = 2006, Texas Instruments Incorporated

IMPORTANT NOTICE

Texas Instruments Incorporated and its subsidiaries (TI) reserve the right to make corrections, modifications, enhancements, improvements, and other changes to its products and services at any time and to discontinue any product or service without notice. Customers should obtain the latest relevant information before placing orders and should verify that such information is current and complete. All products are sold subject to TI's terms and conditions of sale supplied at the time of order acknowledgment.

TI warrants performance of its hardware products to the specifications applicable at the time of sale in accordance with TI's standard warranty. Testing and other quality control techniques are used to the extent TI deems necessary to support this warranty. Except where mandated by government requirements, testing of all parameters of each product is not necessarily performed.

TI assumes no liability for applications assistance or customer product design. Customers are responsible for their products and applications using TI components. To minimize the risks associated with customer products and applications, customers should provide adequate design and operating safeguards.

TI does not warrant or represent that any license, either express or implied, is granted under any TI patent right, copyright, mask work right, or other TI intellectual property right relating to any combination, machine, or process in which TI products or services are used. Information published by TI regarding third-party products or services does not constitute a license from TI to use such products or services or a warranty or endorsement thereof. Use of such information may require a license from a third party under the patents or other intellectual property of the third party, or a license from TI under the patents or other intellectual property of TI.

Reproduction of TI information in TI data books or data sheets is permissible only if reproduction is without alteration and is accompanied by all associated warranties, conditions, limitations, and notices. Reproduction of this information with alteration is an unfair and deceptive business practice. TI is not responsible or liable for such altered documentation. Information of third parties may be subject to additional restrictions.

Resale of TI products or services with statements different from or beyond the parameters stated by TI for that product or service voids all express and any implied warranties for the associated TI product or service and is an unfair and deceptive business practice. TI is not responsible or liable for any such statements.

TI products are not authorized for use in safety-critical applications (such as life support) where a failure of the TI product would reasonably be expected to cause severe personal injury or death, unless officers of the parties have executed an agreement specifically governing such use. Buyers represent that they have all necessary expertise in the safety and regulatory ramifications of their applications, and acknowledge and agree that they are solely responsible for all legal, regulatory and safety-related requirements concerning their products and any use of TI products in such safety-critical applications, notwithstanding any applications-related information or support that may be provided by TI. Further, Buyers must fully indemnify TI and its representatives against any damages arising out of the use of TI products in such safety-critical applications.

TI products are neither designed nor intended for use in military/aerospace applications or environments unless the TI products are specifically designated by TI as military-grade or "enhanced plastic." Only products designated by TI as military-grade meet military specifications. Buyers acknowledge and agree that any such use of TI products which TI has not designated as military-grade is solely at the Buyer's risk, and that they are solely responsible for compliance with all legal and regulatory requirements in connection with such use.

TI products are neither designed nor intended for use in automotive applications or environments unless the specific TI products are designated by TI as compliant with ISO/TS 16949 requirements. Buyers acknowledge and agree that, if they use any non-designated products in automotive applications, TI will not be responsible for any failure to meet such requirements.

Following are URLs where you can obtain information on other Texas Instruments products and application solutions:

Products

Amplifiers	amplifier.ti.com
Data Converters	dataconverter.ti.com
DLP® Products	www.dlp.com
DSP	dsp.ti.com
Clocks and Timers	www.ti.com/clocks
Interface	interface.ti.com
Logic	logic.ti.com
Power Mgmt	power.ti.com
Microcontrollers	microcontroller.ti.com
RFID	www.ti-rfid.com
RF/IF and ZigBee® Solutions	www.ti.com/lprf

Applications

Audio	www.ti.com/audio
Automotive	www.ti.com/automotive
Broadband	www.ti.com/broadband
Digital Control	www.ti.com/digitalcontrol
Medical	www.ti.com/medical
Military	www.ti.com/military
Optical Networking	www.ti.com/opticalnetwork
Security	www.ti.com/security
Telephony	www.ti.com/telephony
Video & Imaging	www.ti.com/video
Wireless	www.ti.com/wireless

Mailing Address: Texas Instruments, Post Office Box 655303, Dallas, Texas 75265
Copyright © 2009, Texas Instruments Incorporated