

Schottky Diode Gen²

$$V_{RRM} = 100V$$

$$I_{FAV} = 2 \times 25A$$

$$V_F = 0.72V$$

High Performance Schottky Diode
Low Loss and Soft Recovery
Common Cathode

Part number

DSA50C100HB

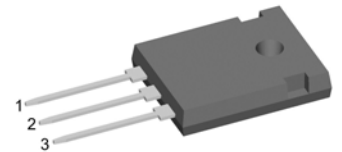

Backside: cathode

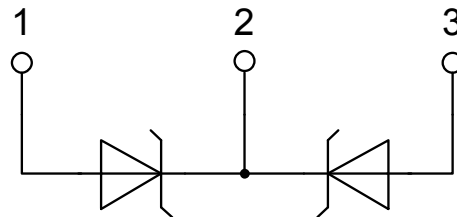

Features / Advantages:

- Very low V_f
- Extremely low switching losses
- Low I_{rm} values
- Improved thermal behaviour
- High reliability circuit operation
- Low voltage peaks for reduced protection circuits
- Low noise switching

Applications:

- Rectifiers in switch mode power supplies (SMPS)
- Free wheeling diode in low voltage converters

Package: TO-247

- Industry standard outline
- RoHS compliant
- Epoxy meets UL 94V-0

Schottky				Ratings		
Symbol	Definition	Conditions	min.	typ.	max.	Unit
V_{RSM}	max. non-repetitive reverse blocking voltage				100	V
V_{RRM}	max. repetitive reverse blocking voltage				100	V
I_R	reverse current, drain current	$V_R = 100\text{ V}$			450	μA
		$V_R = 100\text{ V}$			5	mA
V_F	forward voltage drop	$I_F = 25\text{ A}$			0.90	V
		$I_F = 50\text{ A}$			1.07	V
		$I_F = 25\text{ A}$			0.72	V
		$I_F = 50\text{ A}$			0.90	V
I_{FAV}	average forward current	$T_C = 155^\circ\text{C}$			25	A
		rectangular $d = 0.5$				
V_{FO}	threshold voltage	} for power loss calculation only			0.45	V
r_F	slope resistance				7.3	m Ω
R_{thJC}	thermal resistance junction to case				0.95	K/W
R_{thCH}	thermal resistance case to heatsink			0.25		K/W
P_{tot}	total power dissipation				160	W
I_{FSM}	max. forward surge current	$t = 10\text{ ms}; (50\text{ Hz}), \text{ sine}; V_R = 0\text{ V}$			440	A
C_J	junction capacitance	$V_R = 12\text{ V}$ $f = 1\text{ MHz}$			289	pF

Package TO-247			Ratings			
Symbol	Definition	Conditions	min.	typ.	max.	Unit
I_{RMS}	RMS current	per terminal ¹⁾			50	A
T_{VJ}	virtual junction temperature		-55		175	°C
T_{op}	operation temperature		-55		150	°C
T_{stg}	storage temperature		-55		150	°C
Weight				6		g
M_D	mounting torque		0.8		1.2	Nm
F_C	mounting force with clip		20		120	N

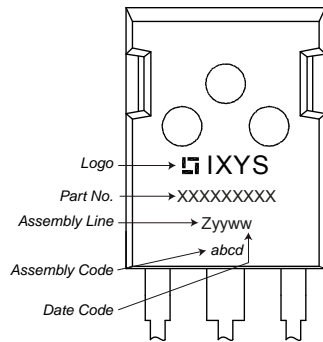
Product Marking

Part number

- D = Diode
- S = Schottky Diode
- A = low VF
- 50 = Current Rating [A]
- C = Common Cathode
- 100 = Reverse Voltage [V]
- HB = TO-247AD (3)

Ordering	Part Number	Marking on Product	Delivery Mode	Quantity	Code No.
Standard	DSA50C100HB	DSA50C100HB	Tube	30	502774

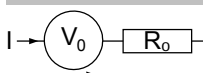
Similar Part	Package	Voltage class
DSA50C100QB	TO-3P (3)	100
DSA60C100PB	TO-220AB (3)	100

Equivalent Circuits for Simulation
** on die level*
 $T_{VJ} = 175\text{ °C}$

Schottky

$V_{0\ max}$	threshold voltage	0.45	V
$R_{0\ max}$	slope resistance *	4.7	mΩ

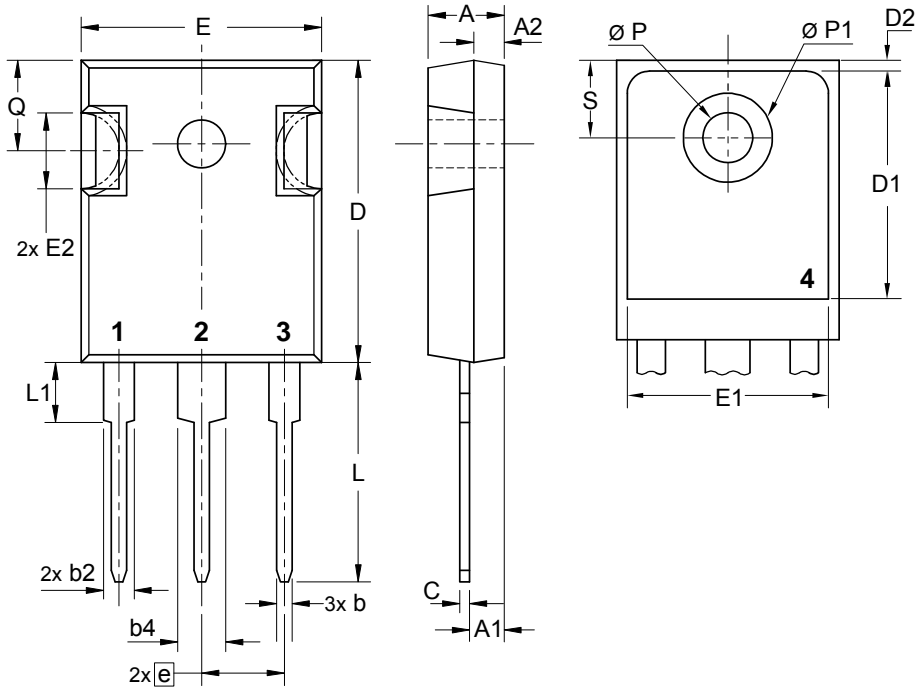
Outlines TO-247

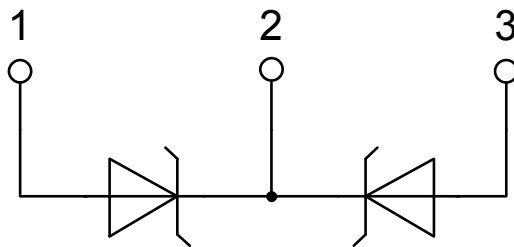

Sym.	Inches		Millimeter	
	min.	max.	min.	max.
A	0.185	0.209	4.70	5.30
A1	0.087	0.102	2.21	2.59
A2	0.059	0.098	1.50	2.49
D	0.819	0.845	20.79	21.45
E	0.610	0.640	15.48	16.24
E2	0.170	0.216	4.31	5.48
e	0.215 BSC		5.46 BSC	
L	0.780	0.800	19.80	20.30
L1	-	0.177	-	4.49
Ø P	0.140	0.144	3.55	3.65
Q	0.212	0.244	5.38	6.19
S	0.242 BSC		6.14 BSC	
b	0.039	0.055	0.99	1.40
b2	0.065	0.094	1.65	2.39
b4	0.102	0.135	2.59	3.43
c	0.015	0.035	0.38	0.89
D1	0.515	-	13.07	-
D2	0.020	0.053	0.51	1.35
E1	0.530	-	13.45	-
Ø P1	-	0.29	-	7.39



Schottky

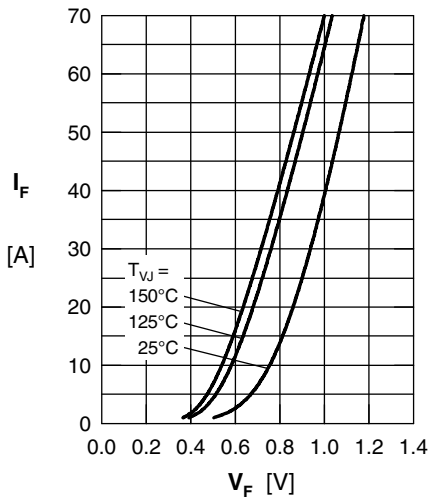

Fig. 1 Maximum forward voltage drop characteristics

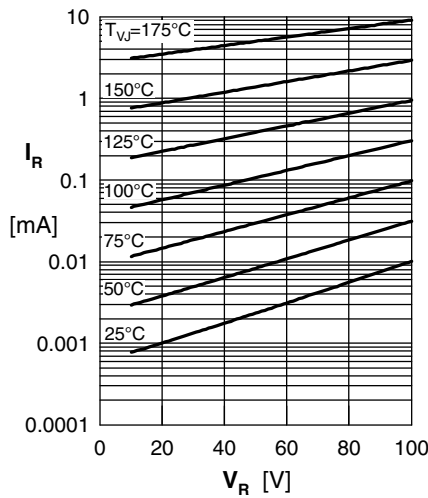

Fig. 2 Typ. reverse current I_R vs. reverse voltage V_R

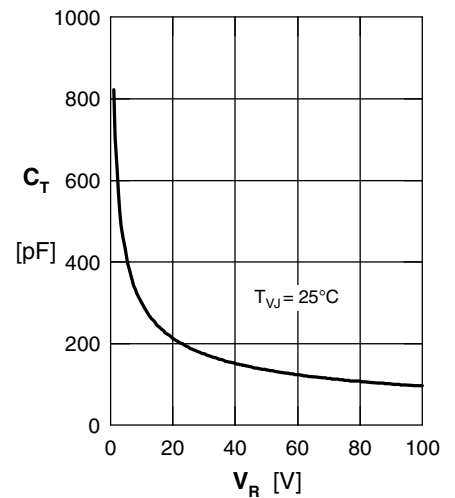

Fig. 3 Typ. junction capacitance C_T vs. reverse voltage V_R

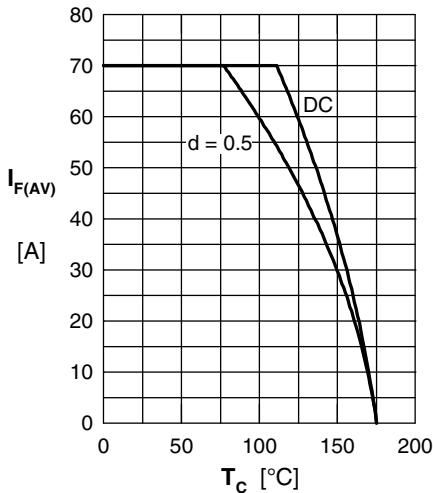

Fig. 4 Average forward current $I_{F(AV)}$ vs. case temperature T_C

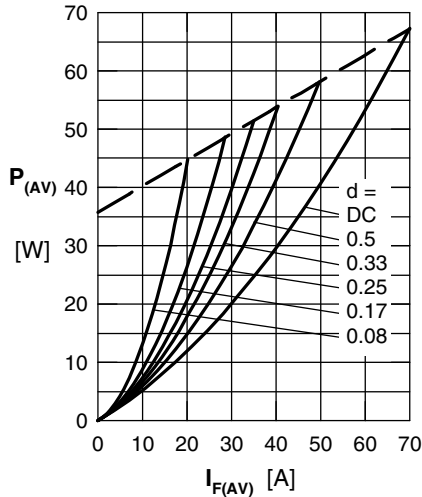

Fig. 5 Forward power loss characteristics

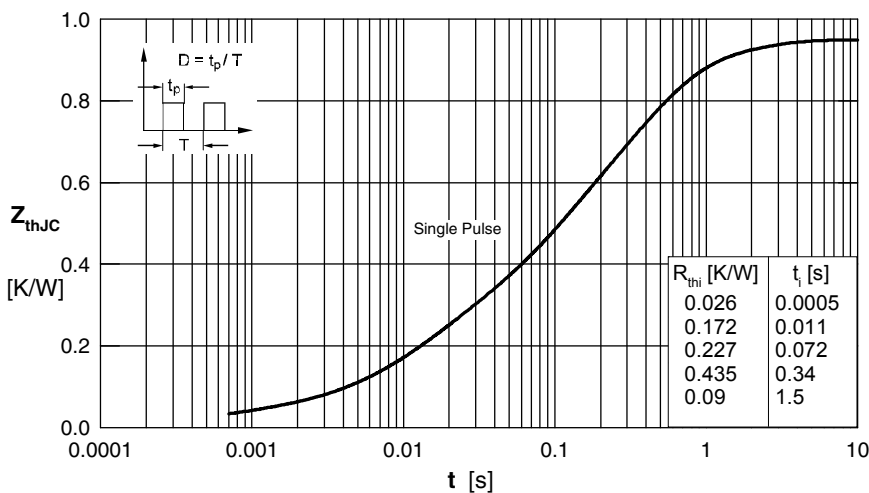

Fig. 6 Transient thermal impedance junction to case

Note: All curves are per diode

Mouser Electronics

Authorized Distributor

Click to View Pricing, Inventory, Delivery & Lifecycle Information:

[IXYS:](#)

[DSA50C100HB](#)