

80×80×25 mm

San Ace 80 9R type    Model 109R0812E401 is not certified.



General Specifications

- Material Frame: Plastic (Flammability: UL 94V-0), Impeller: Plastic (Flammability: UL 94V-1)
- Expected life See the table below. (L10 life: 90% survival rate for continuous operation in free air at 60°C, rated voltage)
- Motor protection function Locked rotor burnout protection, Reverse polarity protection
For details, please refer to p. 529.
- Dielectric strength 50/60 Hz, 500 VAC, for 1 minute (between lead wire conductors and frame)
- Insulation resistance 10 MΩ or more with a 500 VDC megger (between lead wire conductors and frame)
- Sound pressure level (SPL) At 1 m away from the air inlet
- Storage temperature -30 to +70°C (Non-condensing)
- Lead wire ⊕Red ⊖Black or Blue (Sensor) Yellow
- Mass 110 g

Specifications

The models listed below **have ribs and pulse sensors.** For models without ribs, append "1" to the end of model numbers.

Model no.	Rated voltage [V]	Operating voltage range [V]	Rated current [A]	Rated input [W]	Rated speed [min ⁻¹]	Max. airflow [m ³ /min] [CFM]	Max. static pressure [Pa] [inchH ₂ O]	SPL [dB (A)]	Operating temperature [°C]	Expected life [h]										
109R0805F401	5	4.5 to 5.5	0.25	1.25	2600	0.92 32.5	28.4 0.114	26	-20 to +70	60000/60°C										
109R0805M401			0.17	0.85	2350	0.83 29.3	22.5 0.09	23												
109R0812G401	12	10.8 to 13.2	0.37	4.44	4500	1.5 53.0	80.4 0.323	40	-20 to +60	40000/60°C										
109R0812E401			0.24	2.88	3700	1.31 46.3	57.8 0.232	35												
109R0812S401		6 to 13.8	0.18	2.16	3400	1.2	42.4	48.0	0.193	34	-20 to +70	60000/60°C								
109R0812H401													0.13	1.56	2900	1.03	36.4	35.3	0.142	29
109R0812F401													0.11	1.32	2600	0.92	32.5	28.4	0.114	26
109R0812M401													0.09	1.08	2350	0.83	29.3	22.5	0.09	23
109R0812L401		7 to 13.8	0.06	0.72	1850	0.65	23.0	14.7	0.059	20										
109R0824G401		24	20.4 to 26.4	0.2	4.8	4500	1.5 53.0	80.4 0.323	40	-20 to +60	40000/60°C									
109R0824S401	0.1			2.4	3400	1.2	42.4	48.0	0.193			34								
109R0824H401	12 to 27.6		0.07	1.68	2900	1.03	36.4	35.3	0.142	29	-20 to +70	60000/60°C								
109R0824F401													0.06	1.44	2600	0.92	32.5	28.4	0.114	26
109R0824M401													0.05	1.2	2350	0.83	29.3	22.5	0.09	23
109R0824L401													14 to 27.6	0.04	0.96	1850	0.65	23.0	14.7	0.059
109R0848K401	48	40.8 to 55.2	0.1	4.8	4600	1.56 55.1	88.4 0.355	41	-20 to +60	40000/60°C										
109R0848S401			0.06	2.88	3400	1.2	42.4	48.0	0.193	34	-20 to +70	60000/60°C								

Other sensor specifications are available as options. Refer to the index (pp. 545 to 546).

Airflow - Static Pressure Characteristics

109R0805F401 With pulse sensor

Operating voltage range

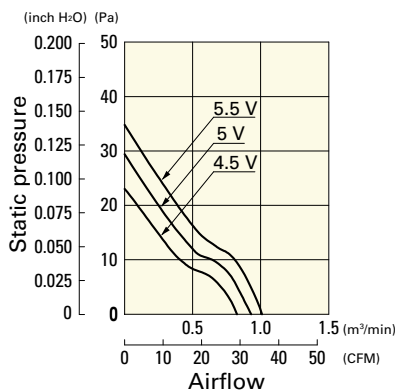

109R0805M401 With pulse sensor

Operating voltage range

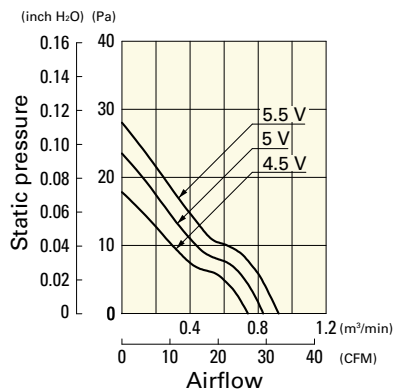

109R0812G401 With pulse sensor

Operating voltage range

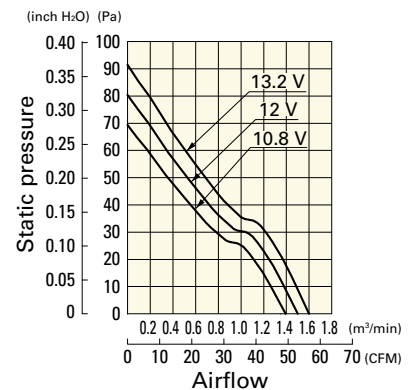

Airflow - Static Pressure Characteristics

109R0812E401 With pulse sensor

Operating voltage range

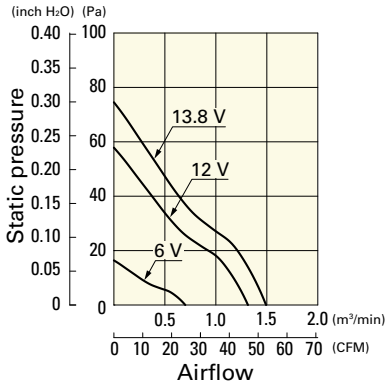

109R0812S401 With pulse sensor

Operating voltage range

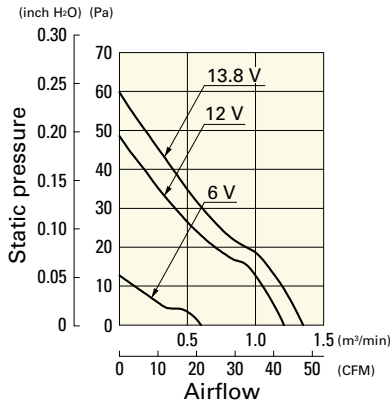

109R0812H401 With pulse sensor

Operating voltage range

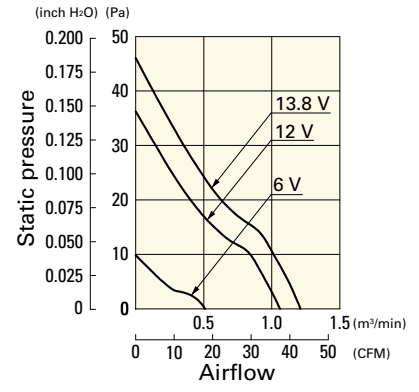

109R0812F401 With pulse sensor

Operating voltage range

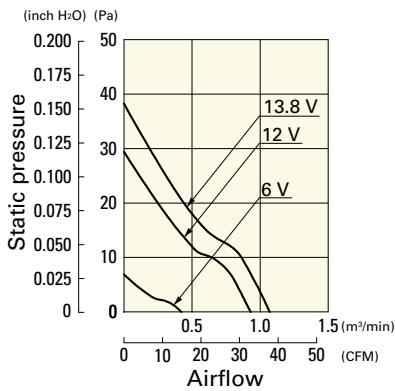

109R0812M401 With pulse sensor

Operating voltage range

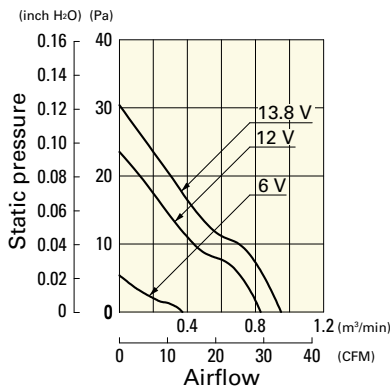

109R0812L401 With pulse sensor

Operating voltage range

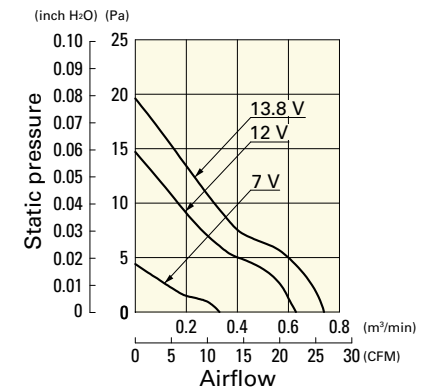

109R0824G401 With pulse sensor

Operating voltage range

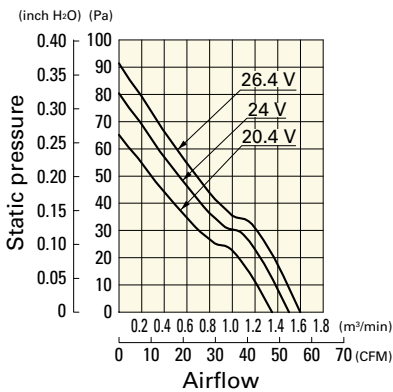

109R0824S401 With pulse sensor

Operating voltage range

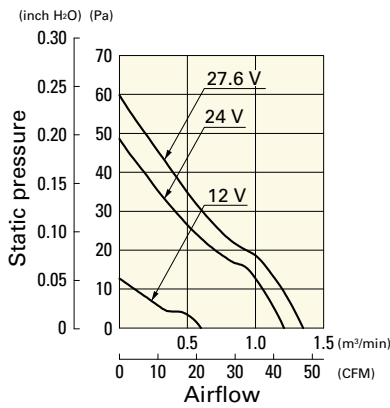

109R0824H401 With pulse sensor

Operating voltage range

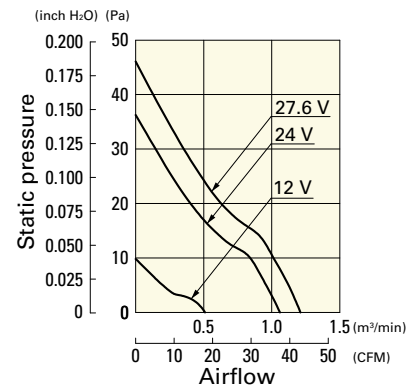

109R0824F401 With pulse sensor

Operating voltage range

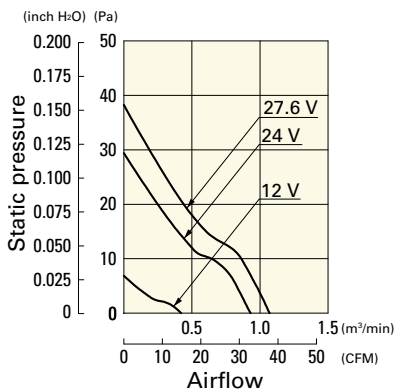

109R0824M401 With pulse sensor

Operating voltage range

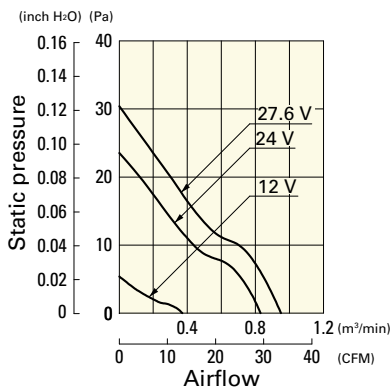

109R0824L401 With pulse sensor

Operating voltage range

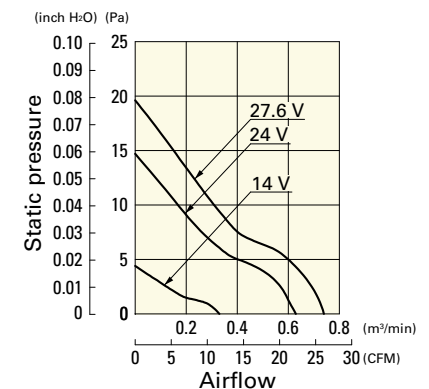

Airflow - Static Pressure Characteristics

109R0848K401 With pulse sensor

Operating voltage range

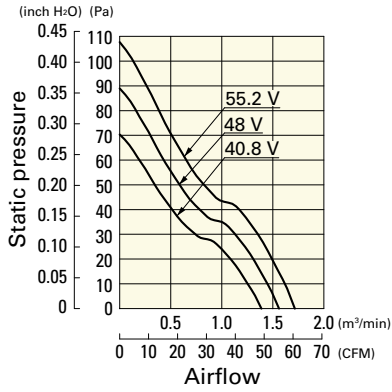

109R0848S401 With pulse sensor

Operating voltage range

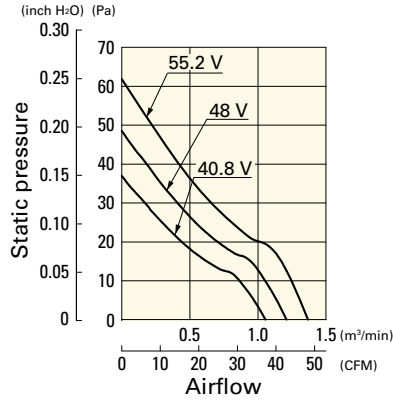

Dimensions (unit: mm) (With ribs)

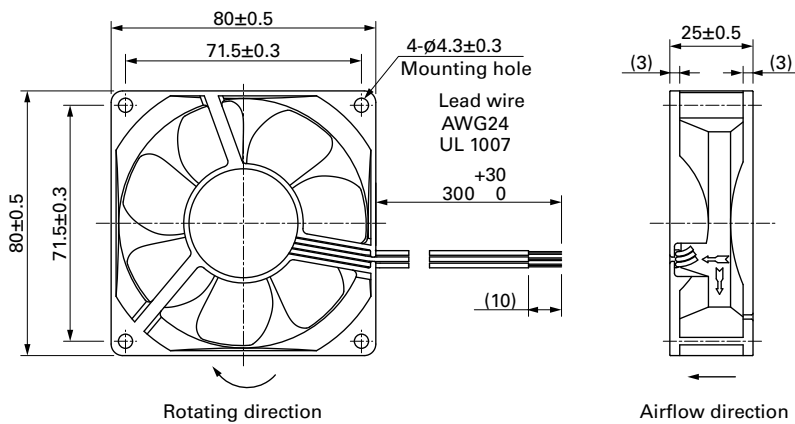

Reference Dimensions of Mounting Holes and Vent Opening (unit: mm)

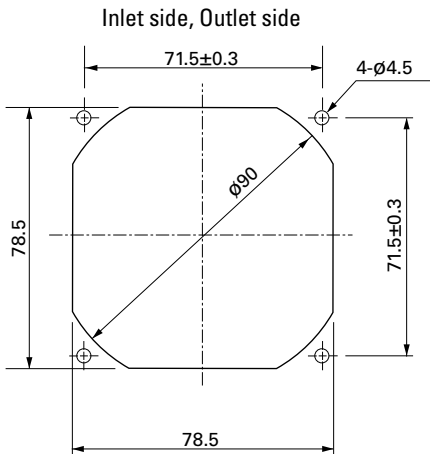

Options

Finger guards

page: p. 513

Model no.: 109-049C, 109-049E, 109-049H

Resin finger guards

page: p. 520

Model no.: 109-1002G

Resin filter kits

page: p. 521

Model no.: 109-1002F13 (13PPI), 109-1002F20 (20PPI),
109-1002F30 (30PPI), 109-1002F40 (40PPI)

Mouser Electronics

Authorized Distributor

Click to View Pricing, Inventory, Delivery & Lifecycle Information:

Sanyo Denki:

[109R0812F402](#) [109R0812G4011](#) [109R0812M4011](#) [109R0812M402](#) [109R0824H401](#) [109R0824M4021](#)
[109R0824S401](#) [109R0824H402](#) [109R0812F4011](#) [109R0824G4011](#) [109R0824S4021](#) [109R0848K4021](#)
[109R0812F401](#) [109R0812S401](#) [109R0824G401](#) [109R0848K401](#) [109R0812G402](#) [109R0824F4011](#) [109R0812H402](#)
[109R0812H4011](#) [109R0848S402](#) [109R0812F4021](#) [109R0812G4021](#) [109R0812M4021](#) [109R0824H4021](#)
[109R0812G401](#) [109R0824M402](#) [109R0824H4011](#) [109R0812H4021](#) [109R0812H401](#) [109R0805F4011](#)
[109R0812S4011](#) [109R0824S4011](#) [109R0805M401](#) [109R0812M401](#) [109R0812L401](#) [109R0824L401](#)
[109R0824L4011](#) [109R0824F401](#) [109R0824M4011](#) [109R0812L4011](#) [109R0848K4011](#) [109R0824M401](#)
[109R0848S401](#) [109R0805F401](#) [109R0848K402](#) [109R0812E402](#) [109R0805F402](#) [109R0824F4D011](#)
[109R0824H4D01](#) [109R0812F4D011](#) [109R0812G4D01](#) [109R0824H4D011](#) [109R0848K4D01](#) [109R0824L402](#)
[109R0812L402](#) [109R0824F402](#) [109R0805F4021](#) [109R0805M4021](#) [109R0848S4021](#) [109R0824L4D011](#)
[109R0824S402](#) [109R0805M402](#) [109R0812L4D01](#) [109R0812H4D01](#) [109R0848K4D011](#) [109R0824M4D01](#)
[109R0824G4D011](#) [109R0824M4D011](#) [109R0824G4021](#) [109R0812M4D011](#) [109R0824L4021](#) [109R0848S4D01](#)
[109R0812S4021](#) [109R0812H4D011](#) [109R0812S4D011](#) [109R0824F4D01](#) [109R0824G4D01](#) [109R0812L4021](#)
[109R0812S402](#) [109R0824G402](#) [109R0805F4D01](#) [109R0824S4D011](#) [109R0824L4D01](#) [109R0812F4D01](#)
[109R0824F4021](#) [109R0824S4D01](#) [109R0812G4D011](#) [109R0812S4D01](#) [109R0805M4D01](#) [109R0812L4D011](#)
[109R0812M4D01](#) [109R0812E401](#) [109R0805M4011](#)