

IRLZ34NPbF

HEXFET® Power MOSFET

- Logic-Level Gate Drive
- Advanced Process Technology
- Dynamic dv/dt Rating
- 175°C Operating Temperature
- Fast Switching
- Fully Avalanche Rated
- Lead-Free

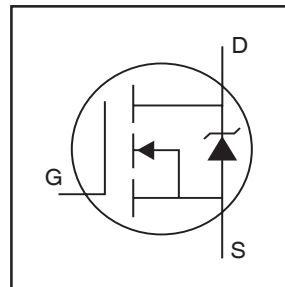

$V_{DSS} = 55V$
$R_{DS(on)} = 0.035\Omega$
$I_D = 30A$

Description

Fifth Generation HEXFETs from International Rectifier utilize advanced processing techniques to achieve the lowest possible on-resistance per silicon area. This benefit, combined with the fast switching speed and ruggedized device design that HEXFET Power MOSFETs are well known for, provides the designer with an extremely efficient device for use in a wide variety of applications.

The TO-220 package is universally preferred for all commercial-industrial applications at power dissipation levels to approximately 50 watts. The low thermal resistance and low package cost of the TO-220 contribute to its wide acceptance throughout the industry.

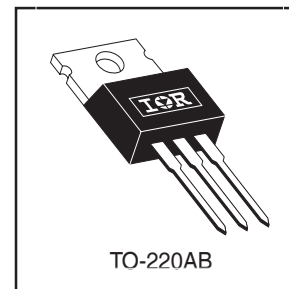

Absolute Maximum Ratings

	Parameter	Max.	Units
$I_D @ T_C = 25^\circ C$	Continuous Drain Current, $V_{GS} @ 10V$	30	A
$I_D @ T_C = 100^\circ C$	Continuous Drain Current, $V_{GS} @ 10V$	21	
I_{DM}	Pulsed Drain Current $\text{\textcircled{D}}$	110	
$P_D @ T_C = 25^\circ C$	Power Dissipation	68	W
	Linear Derating Factor	0.45	W/°C
V_{GS}	Gate-to-Source Voltage	± 16	V
E_{AS}	Single Pulse Avalanche Energy $\text{\textcircled{2}}$	110	mJ
I_{AR}	Avalanche Current $\text{\textcircled{D}}$	16	A
E_{AR}	Repetitive Avalanche Energy $\text{\textcircled{D}}$	6.8	mJ
dv/dt	Peak Diode Recovery dv/dt $\text{\textcircled{3}}$	5.0	V/ns
T_J	Operating Junction and	-55 to + 175	°C
T_{STG}	Storage Temperature Range		
	Soldering Temperature, for 10 seconds	300 (1.6mm from case)	
	Mounting torque, 6-32 or M3 screw.	10 lbf•in (1.1N•m)	

Thermal Resistance

	Parameter	Min.	Typ.	Max.	Units
$R_{\theta JC}$	Junction-to-Case	---	---	2.2	°CW
$R_{\theta CS}$	Case-to-Sink, Flat, Greased Surface	---	0.50	---	
$R_{\theta JA}$	Junction-to-Ambient	---	---	62	

IRLZ34NPbF

International
IR Rectifier

Electrical Characteristics @ T_J = 25°C (unless otherwise specified)

	Parameter	Min.	Typ.	Max.	Units	Conditions
V _{(BR)DSS}	Drain-to-Source Breakdown Voltage	55	—	—	V	V _{GS} = 0V, I _D = 250μA
ΔV _{(BR)DSS/ΔT_J}	Breakdown Voltage Temp. Coefficient	—	0.065	—	V/°C	Reference to 25°C, I _D = 1mA
R _{DS(on)}	Static Drain-to-Source On-Resistance	—	—	0.035	Ω	V _{GS} = 10V, I _D = 16A ④
		—	—	0.046		V _{GS} = 5.0V, I _D = 16A ④
		—	—	0.060		V _{GS} = 4.0V, I _D = 14A ④
V _{GS(th)}	Gate Threshold Voltage	1.0	—	2.0	V	V _{DS} = V _{GS} , I _D = 250μA
g _{fs}	Forward Transconductance	11	—	—	S	V _{DS} = 25V, I _D = 16A
I _{DSS}	Drain-to-Source Leakage Current	—	—	25	μA	V _{DS} = 55V, V _{GS} = 0V
		—	—	250		V _{DS} = 44V, V _{GS} = 0V, T _J = 150°C
I _{GSS}	Gate-to-Source Forward Leakage	—	—	100	nA	V _{GS} = 16V
	Gate-to-Source Reverse Leakage	—	—	-100		V _{GS} = -16V
Q _g	Total Gate Charge	—	—	25	nC	I _D = 16A
Q _{gs}	Gate-to-Source Charge	—	—	5.2		V _{DS} = 44V
Q _{gd}	Gate-to-Drain ("Miller") Charge	—	—	14		V _{GS} = 5.0V, See Fig. 6 and 13 ④
t _{d(on)}	Turn-On Delay Time	—	8.9	—	ns	V _{DD} = 28V
t _r	Rise Time	—	100	—		I _D = 16A
t _{d(off)}	Turn-Off Delay Time	—	21	—		R _G = 6.5Ω, V _{GS} = 5.0V
t _f	Fall Time	—	29	—		R _D = 1.8Ω, See Fig. 10 ④
L _D	Internal Drain Inductance	—	4.5	—	nH	Between lead, 6mm (0.25in.) from package and center of die contact
L _S	Internal Source Inductance	—	7.5	—		
C _{iss}	Input Capacitance	—	880	—	pF	V _{GS} = 0V
C _{oss}	Output Capacitance	—	220	—		V _{DS} = 25V
C _{rss}	Reverse Transfer Capacitance	—	94	—		f = 1.0MHz, See Fig. 5

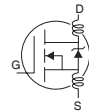

Source-Drain Ratings and Characteristics

	Parameter	Min.	Typ.	Max.	Units	Conditions
I _S	Continuous Source Current (Body Diode)	—	—	30	A	MOSFET symbol showing the integral reverse p-n junction diode.
I _{SM}	Pulsed Source Current (Body Diode) ①	—	—	110		
V _{SD}	Diode Forward Voltage	—	—	1.3	V	T _J = 25°C, I _S = 16A, V _{GS} = 0V ②
t _{rr}	Reverse Recovery Time	—	76	110	ns	T _J = 25°C, I _F = 16A
Q _{rr}	Reverse Recovery Charge	—	190	290	nC	di/dt = 100A/μs ③
t _{on}	Forward Turn-On Time	Intrinsic turn-on time is negligible (turn-on is dominated by L _S +L _D)				

Notes:

- ① Repetitive rating; pulse width limited by max. junction temperature. (See fig. 11)
 ② V_{DD} = 25V, starting T_J = 25°C, L = 610μH
 R_G = 25Ω, I_{AS} = 16A. (See Figure 12)

- ③ I_{SD} ≤ 16A, di/dt ≤ 270A/μs, V_{DD} ≤ V_{(BR)DSS},
 T_J ≤ 175°C
 ④ Pulse width ≤ 300μs; duty cycle ≤ 2%.

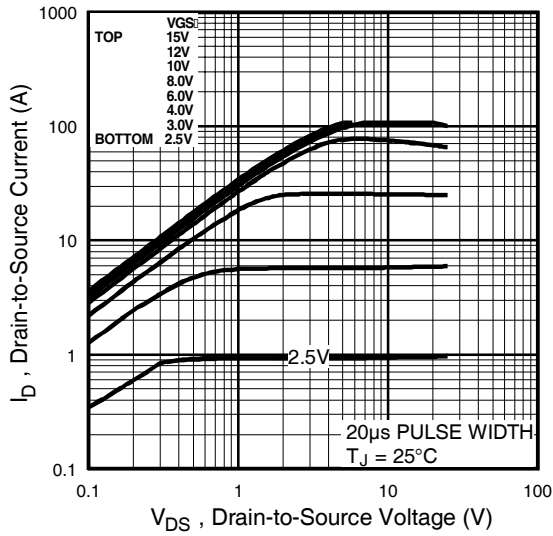

Fig 1. Typical Output Characteristics

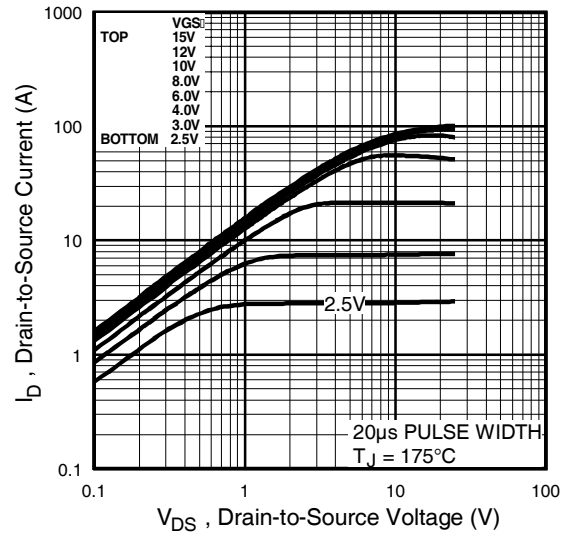

Fig 2. Typical Output Characteristics

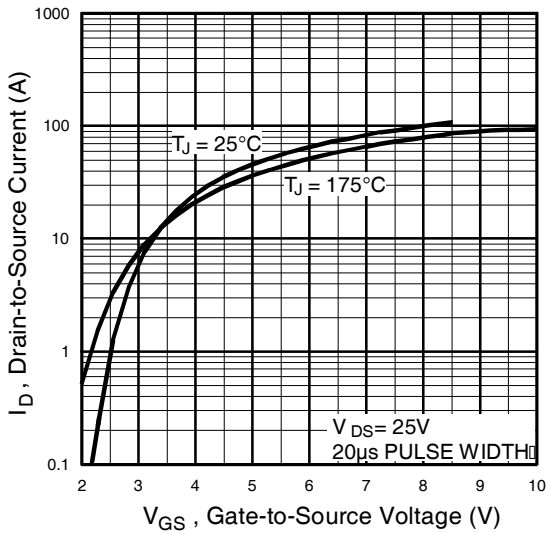

Fig 3. Typical Transfer Characteristics

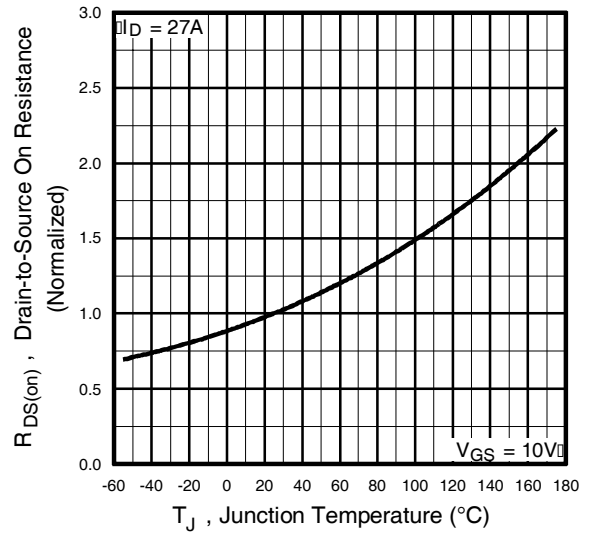

Fig 4. Normalized On-Resistance Vs. Temperature

IRLZ34NPbF

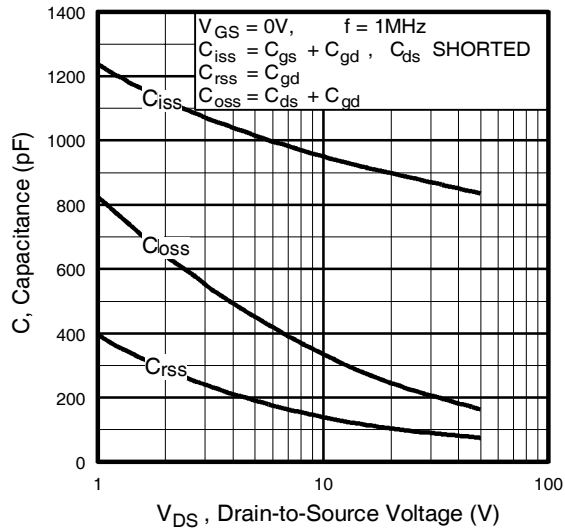

Fig 5. Typical Capacitance Vs. Drain-to-Source Voltage

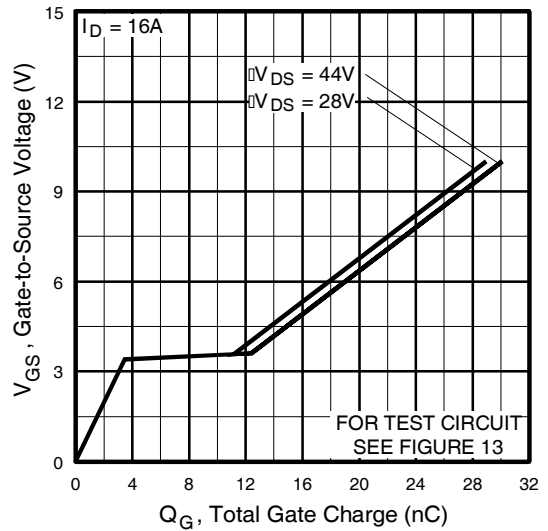

Fig 6. Typical Gate Charge Vs. Gate-to-Source Voltage

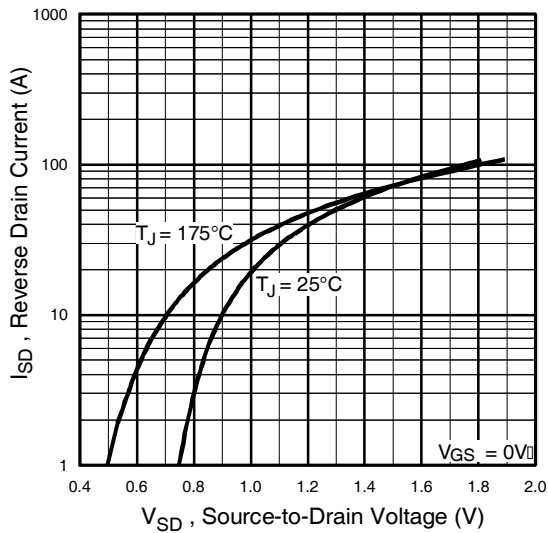

Fig 7. Typical Source-Drain Diode Forward Voltage

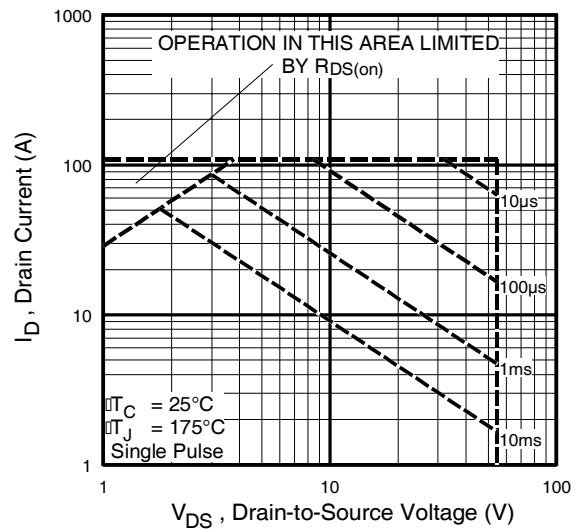

Fig 8. Maximum Safe Operating Area

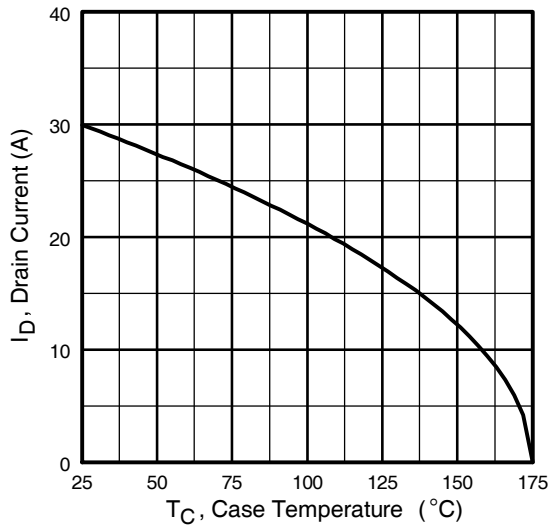

Fig 9. Maximum Drain Current Vs. Case Temperature

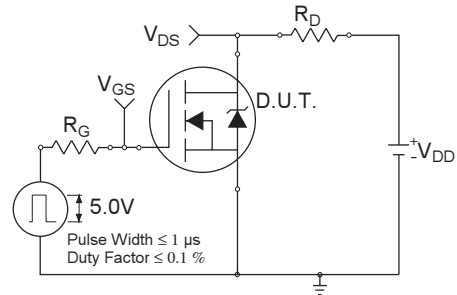

Fig 10a. Switching Time Test Circuit

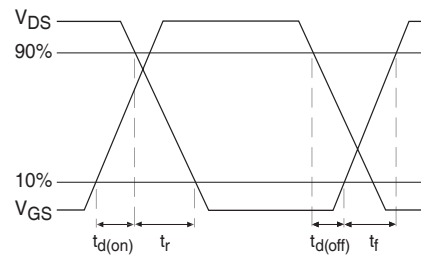

Fig 10b. Switching Time Waveforms

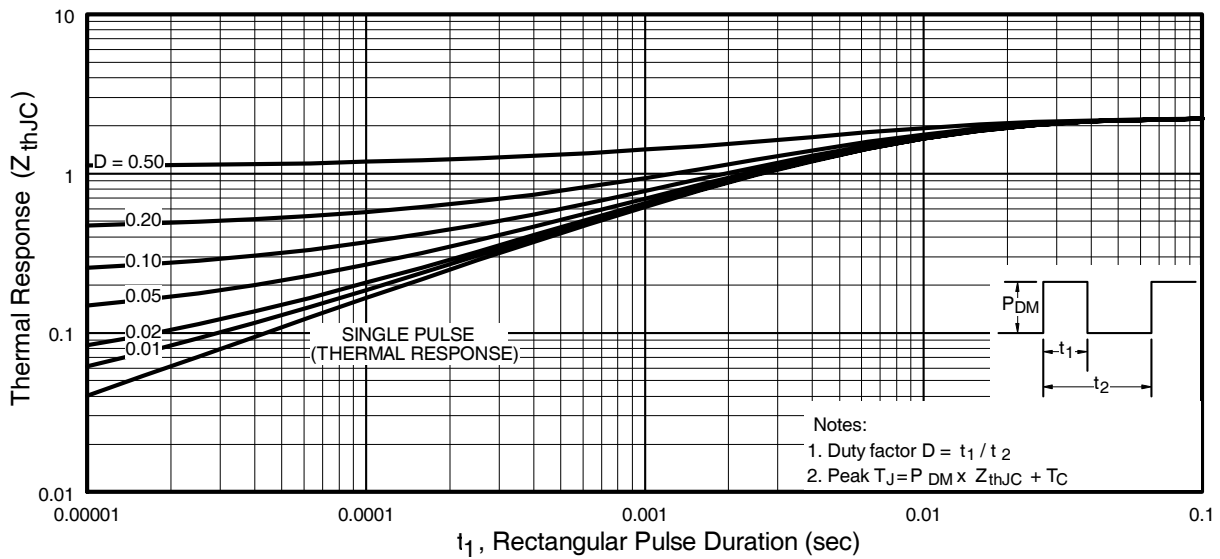

Fig 11. Maximum Effective Transient Thermal Impedance, Junction-to-Case

IRLZ34NPbF

International
IR Rectifier

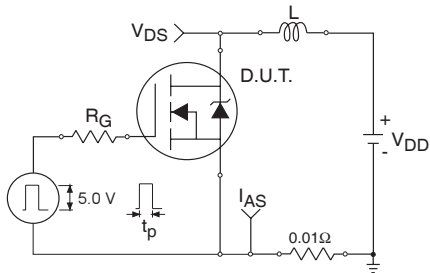

Fig 12a. Unclamped Inductive Test Circuit

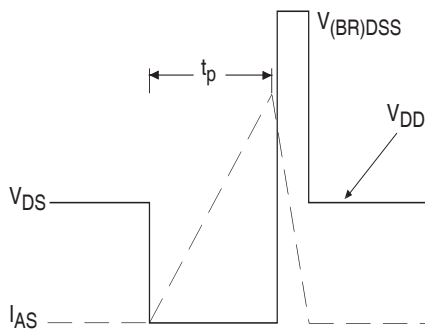

Fig 12b. Unclamped Inductive Waveforms

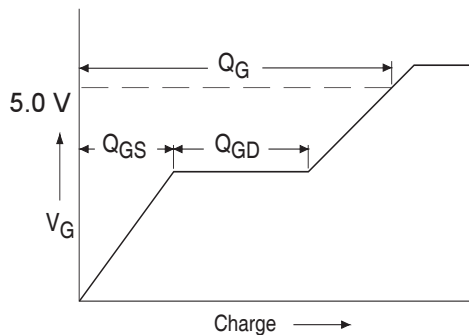

Fig 13a. Basic Gate Charge Waveform

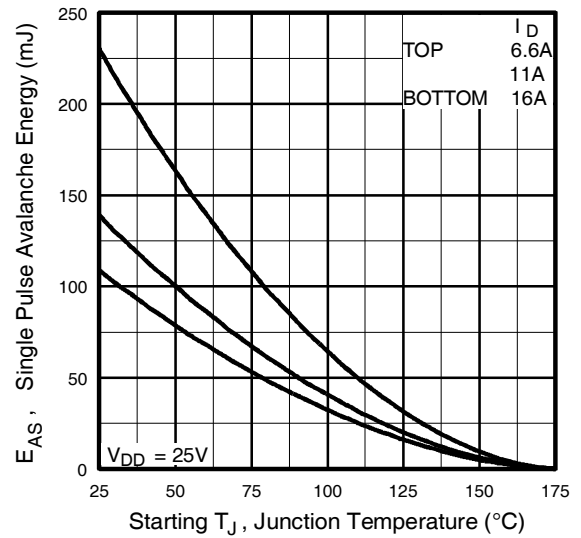

Fig 12c. Maximum Avalanche Energy Vs. Drain Current

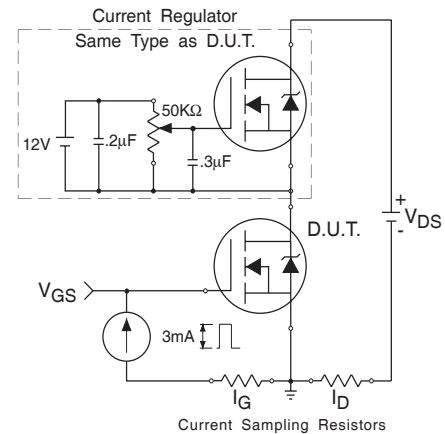
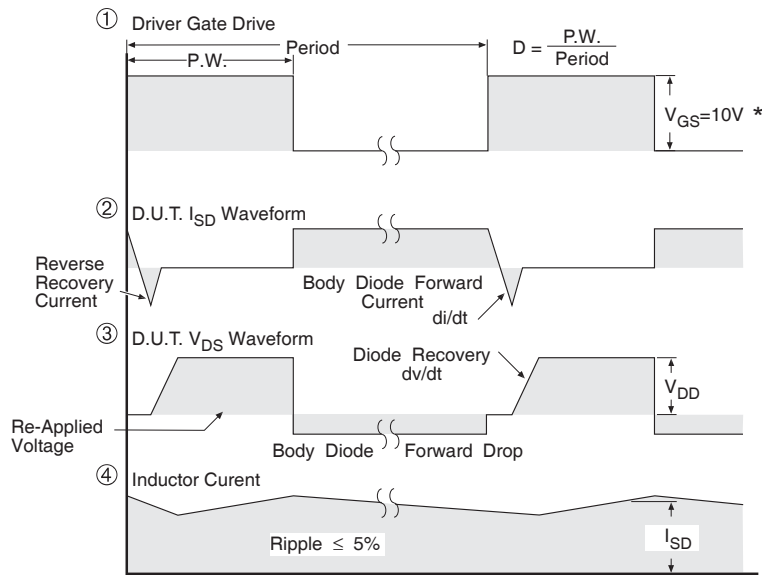

Fig 13b. Gate Charge Test Circuit

Peak Diode Recovery dv/dt Test Circuit



* $V_{GS} = 5V$ for Logic Level Devices

Fig 14. For N-Channel HEXFETS

IRLZ34NPbF

International
IR Rectifier

TO-220AB Package Outline

Dimensions are shown in millimeters (inches)

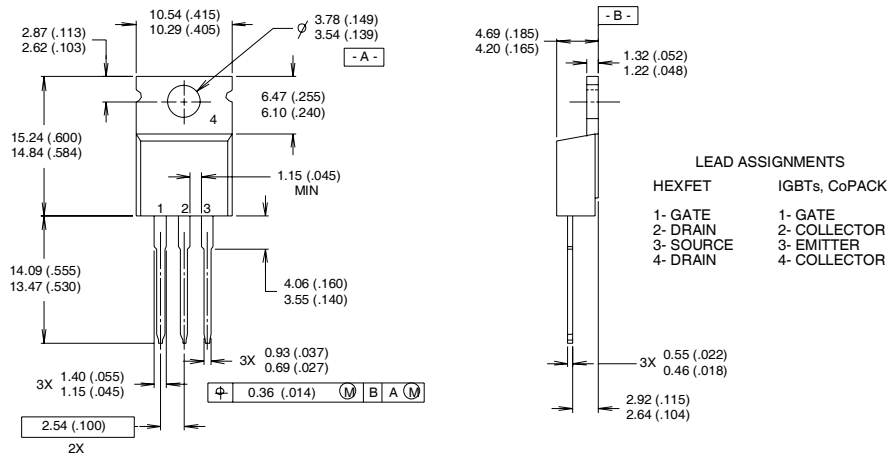

NOTES:

- 1 DIMENSIONING & TOLERANCING PER ANSI Y14.5M, 1982.
- 2 CONTROLLING DIMENSION : INCH

- 3 OUTLINE CONFORMS TO JEDEC OUTLINE TO-220AB.
- 4 HEATSINK & LEAD MEASUREMENTS DO NOT INCLUDE BURRS.

TO-220AB Part Marking Information

EXAMPLE: THIS IS AN IRF1010
 LOT CODE 1789
 ASSEMBLED ON WW 19, 1997
 IN THE ASSEMBLY LINE "C"
Note: "P" in assembly line
 position indicates "Lead-Free"

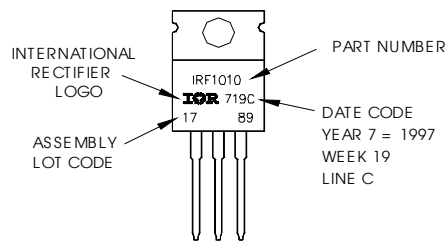

Data and specifications subject to change without notice.

International
IR Rectifier

IR WORLD HEADQUARTERS: 233 Kansas St., El Segundo, California 90245, USA Tel: (310) 252-7105
 TAC Fax: (310) 252-7903

Visit us at www.irf.com for sales contact information.11/03

Note: For the most current drawings please refer to the IR website at:
<http://www.irf.com/package/>

Mouser Electronics

Authorized Distributor

Click to View Pricing, Inventory, Delivery & Lifecycle Information:

[Infineon:](#)

[IRLZ34NPBF](#)