

THIS DRAWING IS UNPUBLISHED.

RELEASED FOR PUBLICATION

ALL RIGHTS RESERVED.

© COPYRIGHT - By -

LOC FT DIST 0

REVISIONS

P	LTR	DESCRIPTION	DATE	DWN	APVD
P		REVISED PER ECO-11-004820	11MAR11	RK	HMR

MATERIAL:
 HOUSING: POLYAMIDE 6, UL94V-2.
 COLOR: NATURAL (OFF WHITE).
 TUBULAR CONTACT: BRASS, TIN PLATED.
 SCREW: M3, STEEL, ZINC PLATED W/ NON-HEXAVALENT CHROMATE (CHROME III).
 WIRE PROTECTION: STAINLESS STEEL.

ELECTRICAL:
 CURRENT RATING: 30A, 250V, 10-22 AWG.
 CURRENT RATING: 25A, 250V, 12-24 AWG.
 WIRE RANGE: 10-24.

ENVIRONMENTAL:
 CONTINUOUS WORKING TEMP.: -35°C TO +100°C.

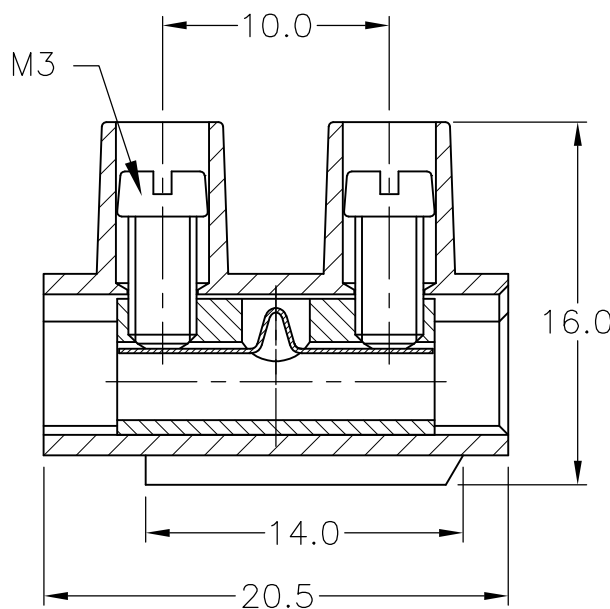
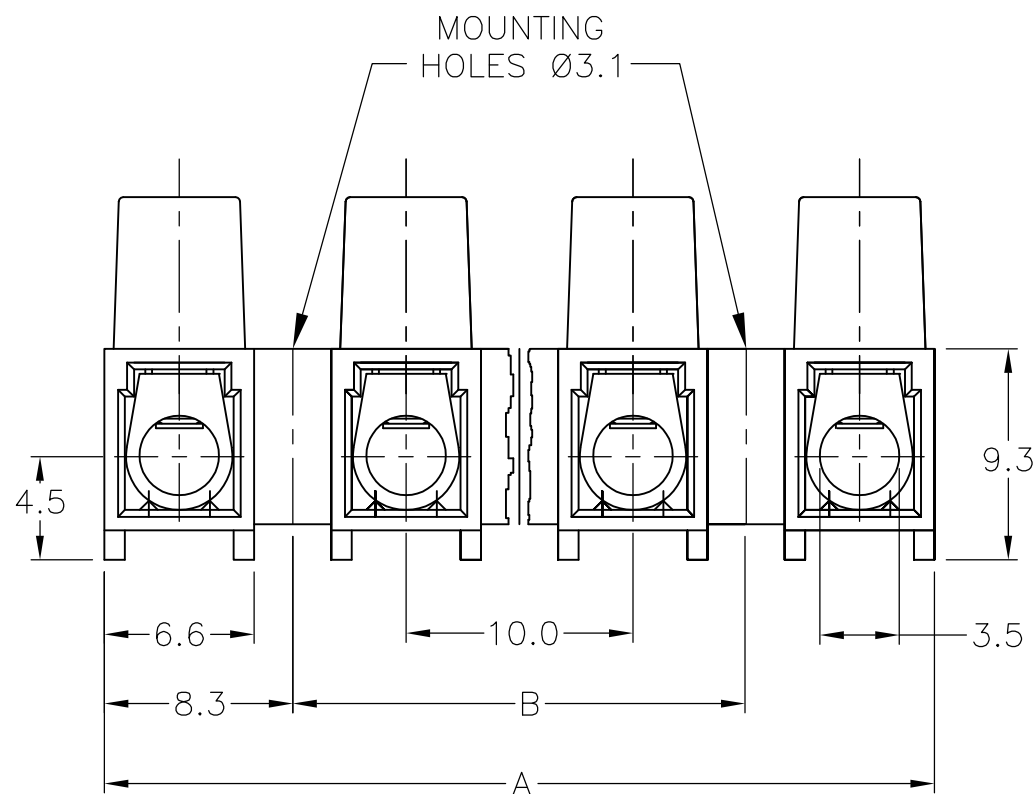

100	116.6	TSB500 1231DS	1-1776296-2
90	106.6	TSB500 1131DS	1-1776296-1
80	96.6	TSB500 1031DS	1-1776296-0
70	86.6	TSB500 0931DS	1776296-9
60	76.6	TSB500 0831DS	1776296-8
50	66.6	TSB500 0731DS	1776296-7
40	56.6	TSB500 0631DS	1776296-6
30	46.6	TSB500 0531DS	1776296-5
20	36.6	TSB500 0431DS	1776296-4
10	26.6	TSB500 0331DS	1776296-3
-	16.6	TSB500 0213DS	1776296-2
-	6.6	TSB500 0131DS	1776296-1
DIM B	DIM A	T & B PART NUMBER	PART NUMBER

THIS DRAWING IS A CONTROLLED DOCUMENT.		DWN S SCHLEGEL 3/18/05	TE Connectivity	
DIMENSIONS: mm		CHK C RICHARD 3/18/05		
TOLERANCES UNLESS OTHERWISE SPECIFIED:		APVD C RICHARD 3/18/05	NAME	
0 PLC ± -		PRODUCT SPEC	EUROPA TERMINAL BLOCK W/WIRE PROTECTOR	
1 PLC ± .3		APPLICATION SPEC	MOUNTING HOLES DIA 3.1, 10mm PITCH	
2 PLC ± .25		WEIGHT -	SIZE A3	CAGE CODE 00779
3 PLC ± -		MATERIAL -	DRAWING NO	RESTRICTED TO
4 PLC ± -			C-1776296	-
ANGLES ± 2		CUSTOMER DRAWING		SCALE NTS
FINISH -		SHEET 1 OF 1		REV P

Mouser Electronics

Authorized Distributor

Click to View Pricing, Inventory, Delivery & Lifecycle Information:

[TE Connectivity:](#)

[1776296-4](#)