



Is Now Part of



**ON Semiconductor®**

To learn more about ON Semiconductor, please visit our website at  
[www.onsemi.com](http://www.onsemi.com)

Please note: As part of the Fairchild Semiconductor integration, some of the Fairchild orderable part numbers will need to change in order to meet ON Semiconductor's system requirements. Since the ON Semiconductor product management systems do not have the ability to manage part nomenclature that utilizes an underscore (\_), the underscore (\_) in the Fairchild part numbers will be changed to a dash (-). This document may contain device numbers with an underscore (\_). Please check the ON Semiconductor website to verify the updated device numbers. The most current and up-to-date ordering information can be found at [www.onsemi.com](http://www.onsemi.com). Please email any questions regarding the system integration to [Fairchild\\_questions@onsemi.com](mailto:Fairchild_questions@onsemi.com).

ON Semiconductor and the ON Semiconductor logo are trademarks of Semiconductor Components Industries, LLC dba ON Semiconductor or its subsidiaries in the United States and/or other countries. ON Semiconductor owns the rights to a number of patents, trademarks, copyrights, trade secrets, and other intellectual property. A listing of ON Semiconductor's product/patent coverage may be accessed at [www.onsemi.com/site/pdf/Patent-Marking.pdf](http://www.onsemi.com/site/pdf/Patent-Marking.pdf). ON Semiconductor reserves the right to make changes without further notice to any products herein. ON Semiconductor makes no warranty, representation or guarantee regarding the suitability of its products for any particular purpose, nor does ON Semiconductor assume any liability arising out of the application or use of any product or circuit, and specifically disclaims any and all liability, including without limitation special, consequential or incidental damages. Buyer is responsible for its products and applications using ON Semiconductor products, including compliance with all laws, regulations and safety requirements or standards, regardless of any support or applications information provided by ON Semiconductor. "Typical" parameters which may be provided in ON Semiconductor data sheets and/or specifications can and do vary in different applications and actual performance may vary over time. All operating parameters, including "Typicals" must be validated for each customer application by customer's technical experts. ON Semiconductor does not convey any license under its patent rights nor the rights of others. ON Semiconductor products are not designed, intended, or authorized for use as a critical component in life support systems or any FDA Class 3 medical devices or medical devices with a same or similar classification in a foreign jurisdiction or any devices intended for implantation in the human body. Should Buyer purchase or use ON Semiconductor products for any such unintended or unauthorized application, Buyer shall indemnify and hold ON Semiconductor and its officers, employees, subsidiaries, affiliates, and distributors harmless against all claims, costs, damages, and expenses, and reasonable attorney fees arising out of, directly or indirectly, any claim of personal injury or death associated with such unintended or unauthorized use, even if such claim alleges that ON Semiconductor was negligent regarding the design or manufacture of the part. ON Semiconductor is an Equal Opportunity/Affirmative Action Employer. This literature is subject to all applicable copyright laws and is not for resale in any manner.



# FDMS9600S

## Dual N-Channel PowerTrench<sup>®</sup> MOSFET

Q1: 30V, 32A, 8.5mΩ Q2: 30V, 30A, 5.5mΩ

### Features

Q1: N-Channel

- Max  $r_{DS(on)}$  = 8.5mΩ at  $V_{GS} = 10V$ ,  $I_D = 12A$
- Max  $r_{DS(on)}$  = 12.4mΩ at  $V_{GS} = 4.5V$ ,  $I_D = 10A$

Q2: N-Channel

- Max  $r_{DS(on)}$  = 5.5mΩ at  $V_{GS} = 10V$ ,  $I_D = 16A$
- Max  $r_{DS(on)}$  = 7.0mΩ at  $V_{GS} = 4.5V$ ,  $I_D = 14A$
- Low Qg high side MOSFET
- Low  $r_{DS(on)}$  low side MOSFET
- Thermally efficient dual Power 56 package
- Pinout optimized for simple PCB design
- RoHS Compliant



### General Description

This device includes two specialized MOSFETs in a unique dual Power 56 package. It is designed to provide an optimal Synchronous Buck power stage in terms of efficiency and PCB utilization. The low switching loss "High Side" MOSFET is complemented by a Low Conduction Loss "Low Side" SyncFET.

### Applications

Synchronous Buck Converter for:

- Notebook System Power
- General Purpose Point of Load

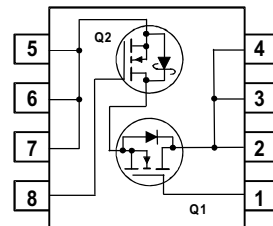
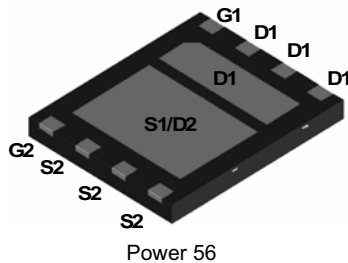

### MOSFET Maximum Ratings $T_A = 25^\circ\text{C}$ unless otherwise noted

Symbol	Parameter	Q1	Q2	Units
$V_{DS}$	Drain to Source Voltage	30	30	V
$V_{GS}$	Gate to Source Voltage	$\pm 20$	$\pm 20$	V
$I_D$	Drain Current -Continuous $T_C = 25^\circ\text{C}$	32	30	A
	-Continuous $T_A = 25^\circ\text{C}$ (Note 1a)	12	16	
	-Pulsed	60	60	
$P_D$	Power Dissipation for Single Operation (Note 1a)	2.5		W
	(Note 1b)	1.0		
$T_J, T_{STG}$	Operating and Storage Junction Temperature Range	-55 to +150		$^\circ\text{C}$

### Thermal Characteristics

$R_{\theta JA}$	Thermal Resistance, Junction to Ambient (Note 1a)	50	$^\circ\text{C/W}$
$R_{\theta JA}$	Thermal Resistance, Junction to Ambient (Note 1b)	120	
$R_{\theta JC}$	Thermal Resistance, Junction to Case	3	

### Package Marking and Ordering Information

Device Marking	Device	Package	Reel Size	Tape Width	Quantity
FDMS9600S	FDMS9600S	Power 56	13"	12mm	3000 units

FDMS9600S Dual N-Channel PowerTrench<sup>®</sup> MOSFET

**Electrical Characteristics**  $T_J = 25^\circ\text{C}$  unless otherwise noted

Symbol	Parameter	Test Conditions	Type	Min	Typ	Max	Units
--------	-----------	-----------------	------	-----	-----	-----	-------

**Off Characteristics**

$BV_{DSS}$	Drain to Source Breakdown Voltage	$I_D = 250\mu\text{A}$ , $V_{GS} = 0\text{V}$ $I_D = 1\text{mA}$ , $V_{GS} = 0\text{V}$	Q1 Q2	30 30			V
$\frac{\Delta BV_{DSS}}{\Delta T_J}$	Breakdown Voltage Temperature Coefficient	$I_D = 250\mu\text{A}$ , referenced to $25^\circ\text{C}$ $I_D = 1\text{mA}$ , referenced to $25^\circ\text{C}$	Q1 Q2		35 29		mV/ $^\circ\text{C}$
$I_{DSS}$	Zero Gate Voltage Drain Current	$V_{DS} = 24\text{V}$ , $V_{GS} = 0\text{V}$	Q1 Q2			1 500	$\mu\text{A}$
$I_{GSS}$	Gate to Source Leakage Current	$V_{GS} = \pm 20\text{V}$ , $V_{DS} = 0\text{V}$	Q1 Q2			$\pm 100$ $\pm 100$	nA nA

**On Characteristics**

$V_{GS(th)}$	Gate to Source Threshold Voltage	$V_{GS} = V_{DS}$ , $I_D = 250\mu\text{A}$ $V_{GS} = V_{DS}$ , $I_D = 1\text{mA}$	Q1 Q2	1 1	1.5 1.8	3 3	V
$\frac{\Delta V_{GS(th)}}{\Delta T_J}$	Gate to Source Threshold Voltage Temperature Coefficient	$I_D = 250\mu\text{A}$ , referenced to $25^\circ\text{C}$ $I_D = 1\text{mA}$ , referenced to $25^\circ\text{C}$	Q1 Q2		-4.5 -6.0		mV/ $^\circ\text{C}$
$r_{DS(on)}$	Drain to Source On Resistance	$V_{GS} = 10\text{V}$ , $I_D = 12\text{A}$ $V_{GS} = 4.5\text{V}$ , $I_D = 10\text{A}$ $V_{GS} = 10\text{V}$ , $I_D = 12\text{A}$ , $T_J = 125^\circ\text{C}$	Q1		7.0 9.2 8.6	8.5 12.4 13.0	m $\Omega$
		$V_{GS} = 10\text{V}$ , $I_D = 16\text{A}$ $V_{GS} = 4.5\text{V}$ , $I_D = 14\text{A}$ $V_{GS} = 10\text{V}$ , $I_D = 16\text{A}$ , $T_J = 125^\circ\text{C}$	Q2		4.5 5.3 5.4	5.5 7.0 8.3	
$g_{FS}$	Forward Transconductance	$V_{DD} = 10\text{V}$ , $I_D = 12\text{A}$ $V_{DD} = 10\text{V}$ , $I_D = 16\text{A}$	Q1 Q2		54 68		S

**Dynamic Characteristics**

$C_{iss}$	Input Capacitance	$V_{DS} = 15\text{V}$ , $V_{GS} = 0\text{V}$ , $f = 1\text{MHz}$	Q1 Q2		1280 2300	1705 3060	pF
$C_{oss}$	Output Capacitance		Q1 Q2		525 1545	700 2055	pF
$C_{rss}$	Reverse Transfer Capacitance		Q1 Q2		80 250	120 375	pF
$R_g$	Gate Resistance		$f = 1\text{MHz}$	Q1 Q2		1.0 1.7	

**Switching Characteristics**

$t_{d(on)}$	Turn-On Delay Time	$V_{DD} = 10\text{V}$ , $I_D = 1\text{A}$ , $V_{GS} = 10\text{V}$ , $R_{GEN} = 6\Omega$	Q1 Q2		13 17	23 31	ns	
$t_r$	Rise Time		Q1 Q2		6 11	12 20	ns	
$t_{d(off)}$	Turn-Off Delay Time		Q1 Q2		42 54	67 86	ns	
$t_f$	Fall Time		Q1 Q2		12 32	22 51	ns	
$Q_{g(TOT)}$	Total Gate Charge		Q1 $V_{DD} = 15\text{V}$ , $V_{GS} = 4.5\text{V}$ , $I_D = 12\text{A}$	Q1 Q2		9 21	13 29	nC
			Q2	Q1 Q2		3 8		nC
$Q_{gs}$	Gate to Source Gate Charge		$V_{DD} = 15\text{V}$ , $V_{GS} = 4.5\text{V}$ , $I_D = 16\text{A}$	Q1 Q2		2.7 6.5		nC
$Q_{gd}$	Gate to Drain "Miller" Charge			Q1 Q2				nC

**Electrical Characteristics**  $T_J = 25^\circ\text{C}$  unless otherwise noted

Symbol	Parameter	Test Conditions	Type	Min	Typ	Max	Units
--------	-----------	-----------------	------	-----	-----	-----	-------

**Drain-Source Diode Characteristics**

$I_S$	Maximum Continuous Drain-Source Diode Forward Current		Q1 Q2			2.1 3.5	A
$V_{SD}$	Source to Drain Diode Forward Voltage	$V_{GS} = 0V, I_S = 2.1A$ (Note 2)	Q1		0.7	1.2	V
		$V_{GS} = 0V, I_S = 3.5A$ (Note 2)	Q2		0.4	1.0	
		$V_{GS} = 0V, I_S = 8.2A$ (Note 2)	Q2		0.5	1.0	
$t_{rr}$	Reverse Recovery Time	Q1 $I_F = 12A, di/dt = 100A/\mu s$	Q1 Q2		33 27		ns
$Q_{rr}$	Reverse Recovery Charge	Q2	Q1		20		nC
		$I_F = 16A, di/dt = 300A/\mu s$	Q2		33		

**Notes:**

1:  $R_{\theta JA}$  is determined with the device mounted on a 1in<sup>2</sup> pad 2 oz copper pad on a 1.5 x 1.5 in. board of FR-4 material.  $R_{\theta JC}$  is guaranteed by design while  $R_{\theta CA}$  is determined by the user's board design.



a.  $50^\circ\text{C/W}$  when mounted on a 1 in<sup>2</sup> pad of 2 oz copper



b.  $120^\circ\text{C/W}$  when mounted on a minimum pad of 2 oz copper

2: Pulse Test: Pulse Width < 300 $\mu s$ , Duty cycle < 2.0%.

**Typical Characteristics (Q1 N-Channel)**  $T_J = 25^\circ\text{C}$  unless otherwise noted

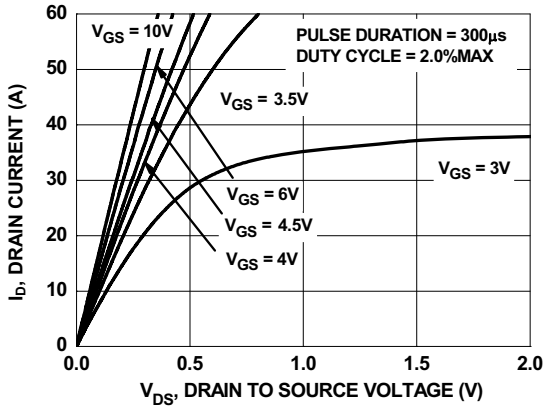

Figure 1. On-Region Characteristics

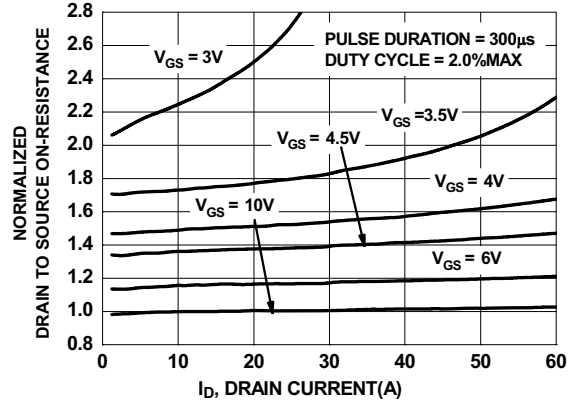

Figure 2. Normalized On-Resistance vs Drain Current and Gate Voltage

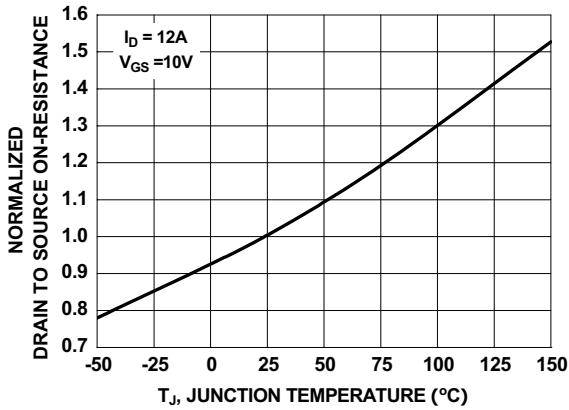

Figure 3. Normalized On-Resistance vs Junction Temperature

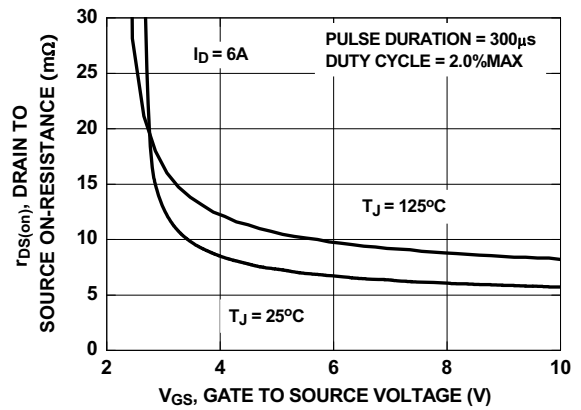

Figure 4. On-Resistance vs Gate to Source Voltage

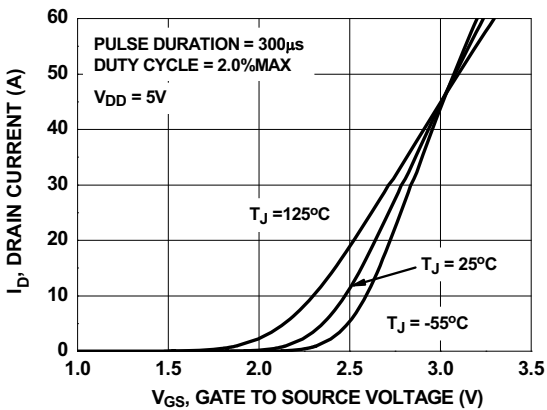

Figure 5. Transfer Characteristics

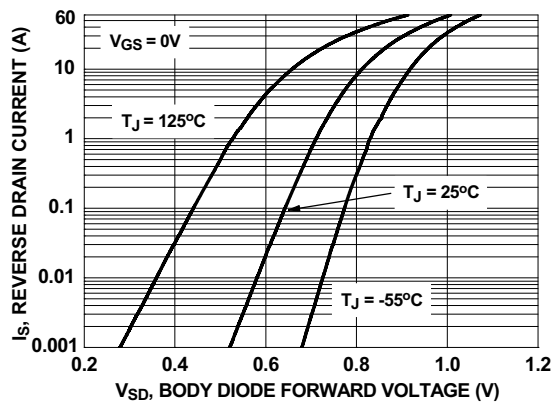

Figure 6. Source to Drain Diode Forward Voltage vs Source Current

**Typical Characteristics (Q1 N-Channel)**  $T_J = 25^\circ\text{C}$  unless otherwise noted

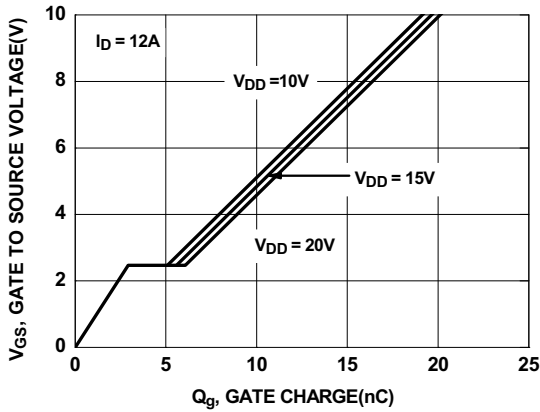

Figure 7. Gate Charge Characteristics

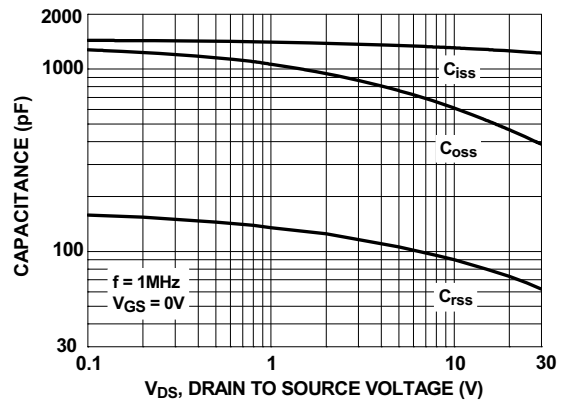

Figure 8. Capacitance vs Drain to Source Voltage

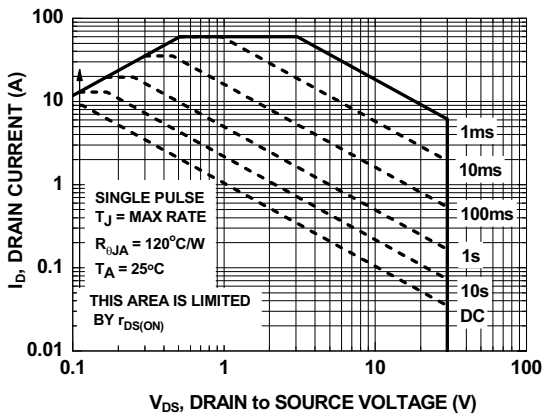

Figure 9. Forward Bias Safe Operating Area

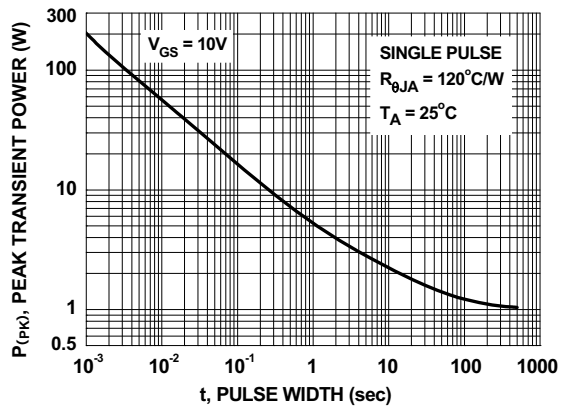

Figure 10. Single Pulse Maximum Power Dissipation

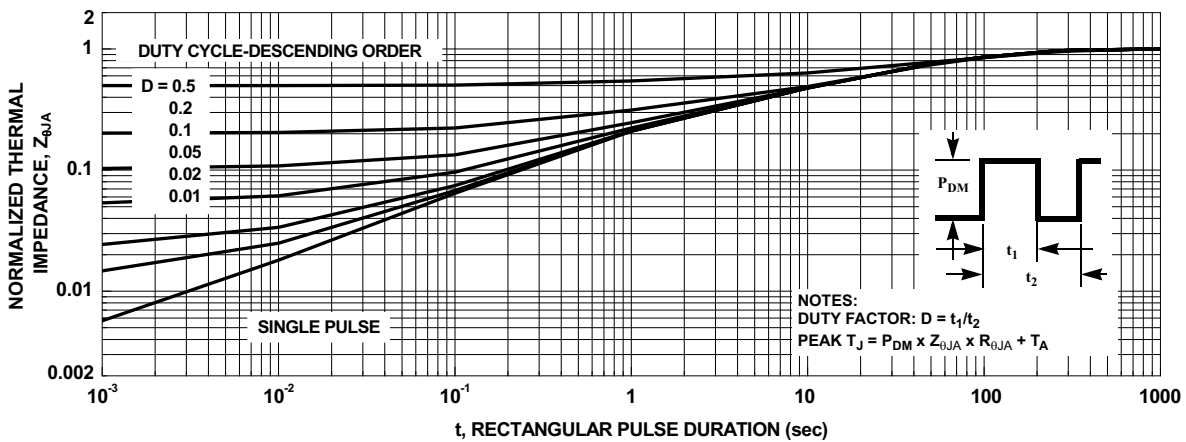

Figure 11. Transient Thermal Response Curve

### Typical Characteristics (Q2 SyncFET)

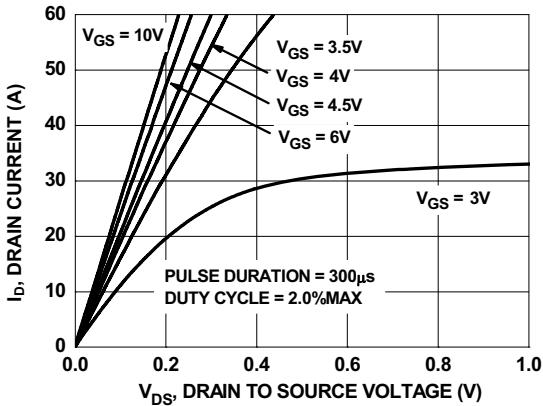

Figure 12. On-Region Characteristics

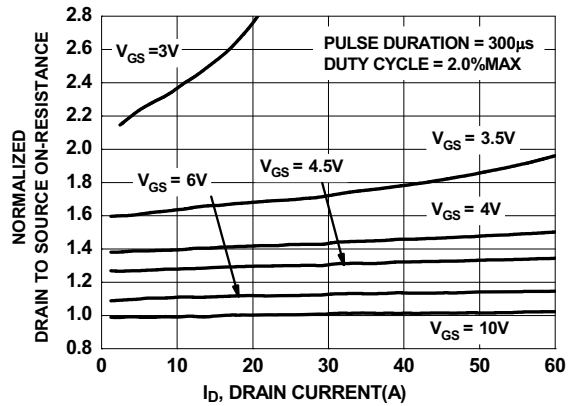

Figure 13. Normalized on-Resistance vs Drain Current and Gate Voltage

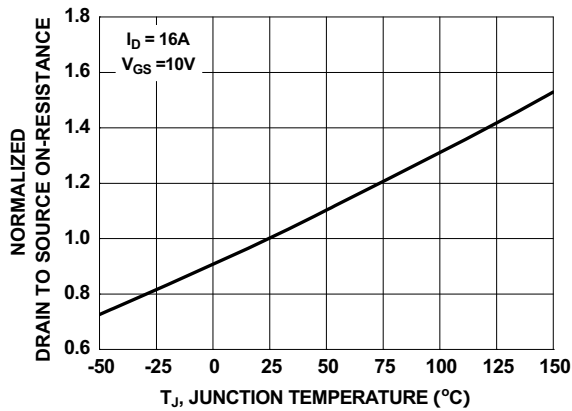

Figure 14. Normalized On-Resistance vs Junction Temperature

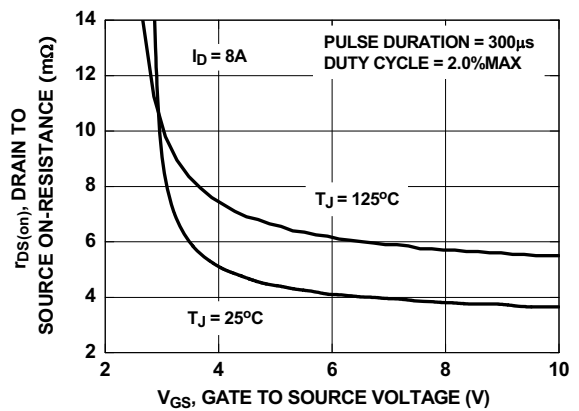

Figure 15. On-Resistance vs Gate to Source Voltage

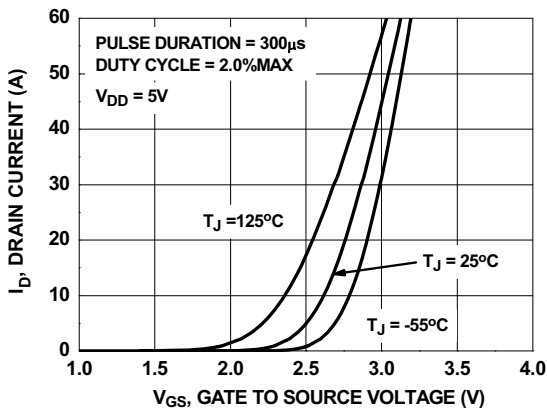

Figure 16. Transfer Characteristics

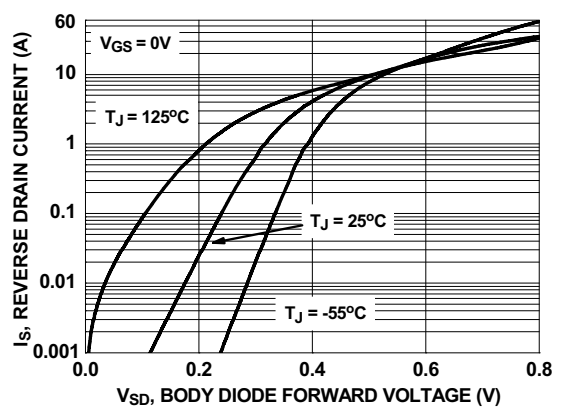

Figure 17. Source to Drain Diode Forward Voltage vs Source Current

### Typical Characteristics

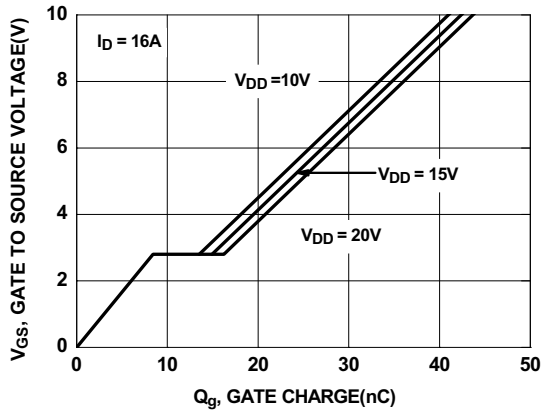

Figure 18. Gate Charge Characteristics

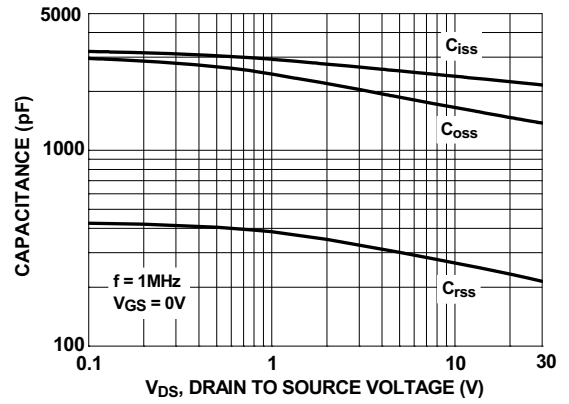
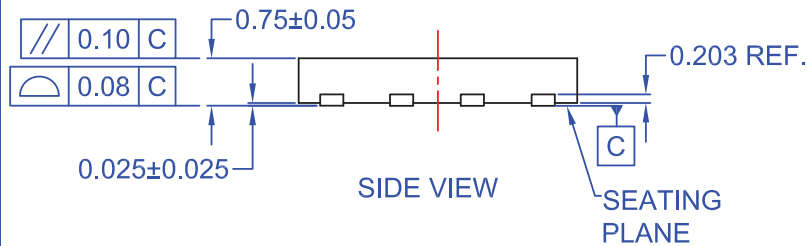
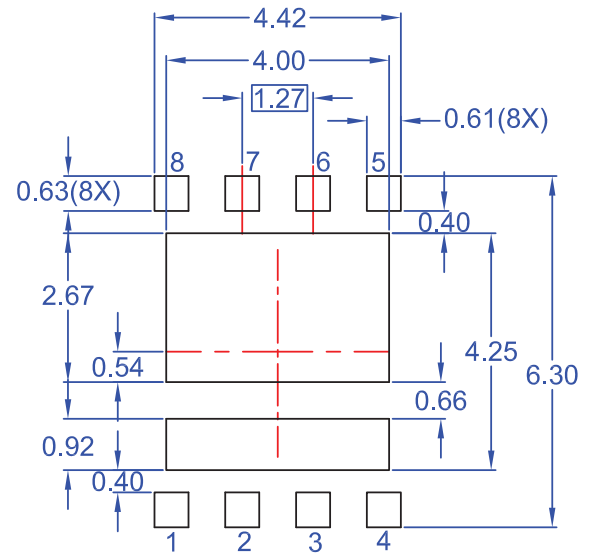
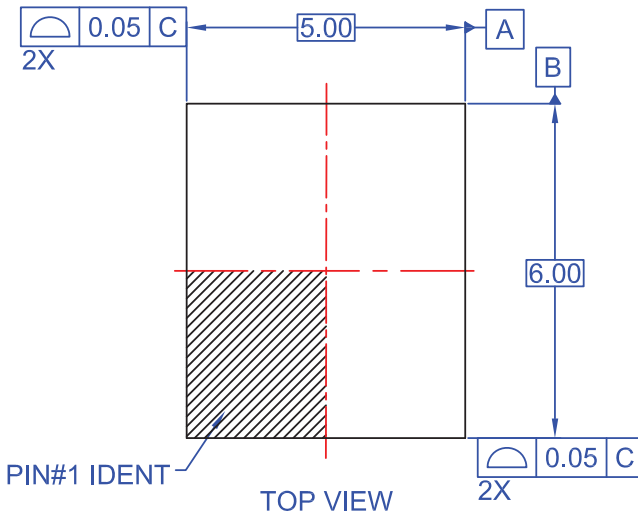

Figure 19. Capacitance vs Drain to Source Voltage





NOTE:

- A. PACKAGE DOES NOT FULLY CONFORM TO JEDEC STANDARD.
- B. DIMENSIONS ARE IN MILLIMETERS.
- C. DIMENSIONS AND TOLERANCES PER ASME Y14.5M, 2009.
- D. LAND PATTERN RECOMMENDATION IS EXISTING INDUSTRY LAND PATTERN.
- E. DRAWING FILENAME: MKT-MLP08Krev3.

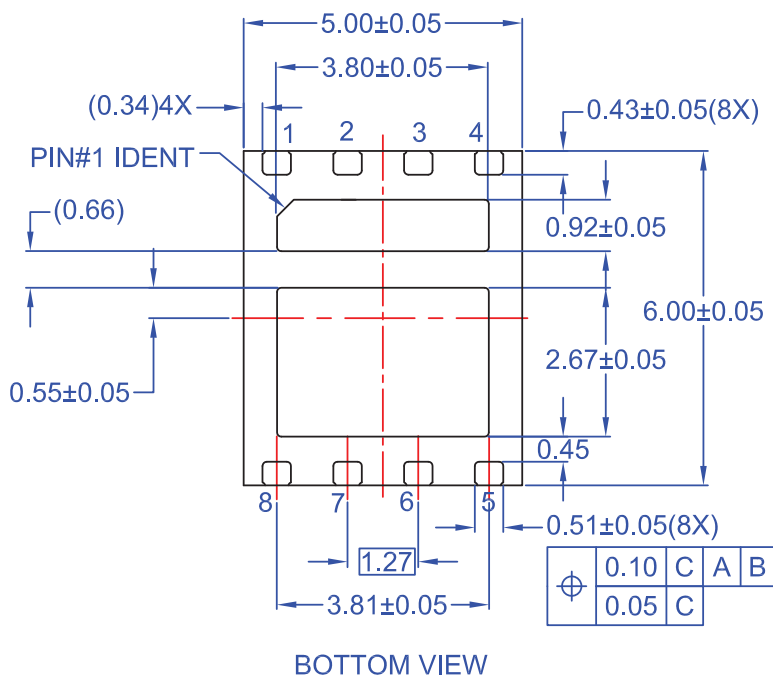

ON Semiconductor and  are trademarks of Semiconductor Components Industries, LLC dba ON Semiconductor or its subsidiaries in the United States and/or other countries. ON Semiconductor owns the rights to a number of patents, trademarks, copyrights, trade secrets, and other intellectual property. A listing of ON Semiconductor's product/patent coverage may be accessed at [www.onsemi.com/site/pdf/Patent-Marking.pdf](http://www.onsemi.com/site/pdf/Patent-Marking.pdf). ON Semiconductor reserves the right to make changes without further notice to any products herein. ON Semiconductor makes no warranty, representation or guarantee regarding the suitability of its products for any particular purpose, nor does ON Semiconductor assume any liability arising out of the application or use of any product or circuit, and specifically disclaims any and all liability, including without limitation special, consequential or incidental damages. Buyer is responsible for its products and applications using ON Semiconductor products, including compliance with all laws, regulations and safety requirements or standards, regardless of any support or applications information provided by ON Semiconductor. "Typical" parameters which may be provided in ON Semiconductor data sheets and/or specifications can and do vary in different applications and actual performance may vary over time. All operating parameters, including "Typicals" must be validated for each customer application by customer's technical experts. ON Semiconductor does not convey any license under its patent rights nor the rights of others. ON Semiconductor products are not designed, intended, or authorized for use as a critical component in life support systems or any FDA Class 3 medical devices or medical devices with a same or similar classification in a foreign jurisdiction or any devices intended for implantation in the human body. Should Buyer purchase or use ON Semiconductor products for any such unintended or unauthorized application, Buyer shall indemnify and hold ON Semiconductor and its officers, employees, subsidiaries, affiliates, and distributors harmless against all claims, costs, damages, and expenses, and reasonable attorney fees arising out of, directly or indirectly, any claim of personal injury or death associated with such unintended or unauthorized use, even if such claim alleges that ON Semiconductor was negligent regarding the design or manufacture of the part. ON Semiconductor is an Equal Opportunity/Affirmative Action Employer. This literature is subject to all applicable copyright laws and is not for resale in any manner.

## PUBLICATION ORDERING INFORMATION

### LITERATURE FULFILLMENT:

Literature Distribution Center for ON Semiconductor  
19521 E. 32nd Pkwy, Aurora, Colorado 80011 USA  
**Phone:** 303-675-2175 or 800-344-3860 Toll Free USA/Canada  
**Fax:** 303-675-2176 or 800-344-3867 Toll Free USA/Canada  
**Email:** [orderlit@onsemi.com](mailto:orderlit@onsemi.com)

**N. American Technical Support:** 800-282-9855 Toll Free  
USA/Canada  
**Europe, Middle East and Africa Technical Support:**  
Phone: 421 33 790 2910  
**Japan Customer Focus Center**  
Phone: 81-3-5817-1050

**ON Semiconductor Website:** [www.onsemi.com](http://www.onsemi.com)  
**Order Literature:** <http://www.onsemi.com/orderlit>  
For additional information, please contact your local  
Sales Representative

# Mouser Electronics

Authorized Distributor

Click to View Pricing, Inventory, Delivery & Lifecycle Information:

[ON Semiconductor:](#)

[FDMS9600S](#)