



80x80x38 mm

San Ace 80 9GV type

General Specifications

- Material Frame: Plastic (Flammability: UL 94V-0), Impeller: Plastic (Flammability: UL 94V-1)
- Expected life See the table below. (L10 life: 90% survival rate for continuous operation in free air at 60°C, rated voltage)
- Motor protection function Locked rotor burnout protection, Reverse polarity protection
For details, please refer to p. 547.
- Dielectric strength 50/60 Hz, 500 VAC, for 1 minute (between lead wire conductors and frame)
- Insulation resistance 10 MΩ or more with a 500 VDC megger (between lead wire conductors and frame)
- Sound pressure level (SPL) At 1 m away from the air inlet
- Storage temperature -30 to +70°C (Non-condensing)
- Lead wire ⊕Red ⊖Black Sensor Yellow Control Brown
- Mass 220 g

Specifications

The models listed below **have ribs and pulse sensors with PWM control function**. For models without ribs, append "1" to the end of model numbers.

Model no.	Rated voltage [V]	Operating voltage range [V]	PWM duty cycle* [%]	Rated current [A]	Rated input [W]	Rated speed [min ⁻¹]	Max. airflow [m ³ /min] [CFM]	Max. static pressure [Pa] [inchH ₂ O]	SPL [dB (A)]	Operating temperature [°C]	Expected life [h]		
9GV0812P1G03	12	10.8 to 13.2	100	3.8	45.6	10200	3.9 138.0	490.0 1.97	65	-20 to +70	40000/60°C		
			0	0.32	3.84	3000	1.15 40.6	42.4 0.17	34				
9GV0812P1H03			100	3.0	36.0	9700	3.7 131.0	440.0 1.77	63				
												0	0.2
9GV0812P1F03			10.2 to 13.8	100	1.5	18	8000	3.05 108.0	301.0 1.21			58	
													0
9GV0812P1M03		100		0.75	9	6000	2.29 81.0	169.0 0.68	51				
												0	0.09
9GV0824P1G03		24		20.4 to 27.6	100	1.6	38.4	10200	3.9 138.0			490.0 1.97	65
					0	0.3	7.2	4700	1.79 63.2			104.0 0.41	44
9GV0848P1G03		48	40.8 to 55.2	100	0.84	40.32	10200	3.9 138.0	490.0 1.97			65	
				0	0.15	7.2	4700	1.79 63.2	104.0 0.41			44	

* PWM frequency: 25 kHz

The following sensor and control options are available for selection.

Differs according to the model. Refer to the table on p. 574. Without sensor Pulse sensor

Airflow - Static Pressure Characteristics / PWM Duty - Speed Characteristics Example

9GV0812P1G03 With pulse sensor with PWM control function

PWM duty cycle

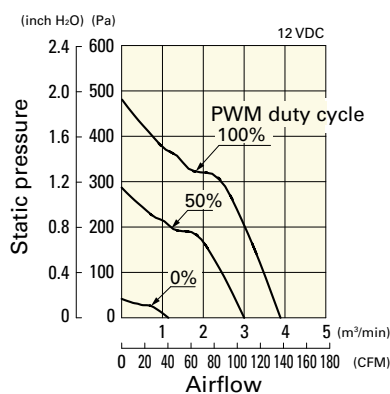

Operating voltage range

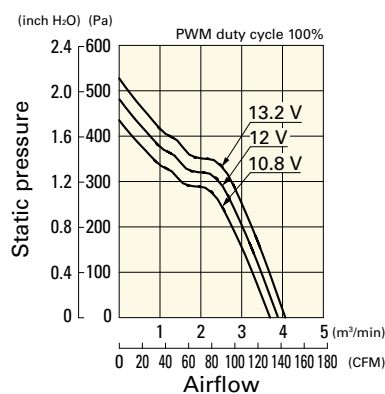

PWM duty - Speed characteristics example

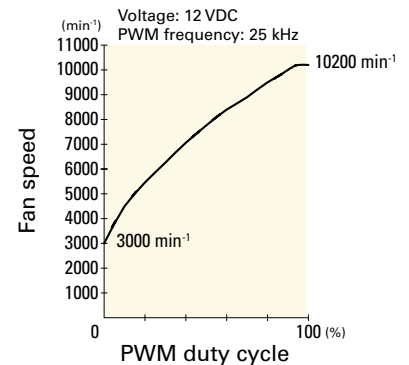

Airflow - Static Pressure Characteristics / PWM Duty - Speed Characteristics Example

9GV0812P1H03 With pulse sensor with PWM control function

PWM duty cycle

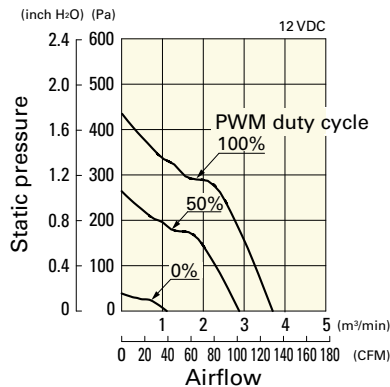

Operating voltage range

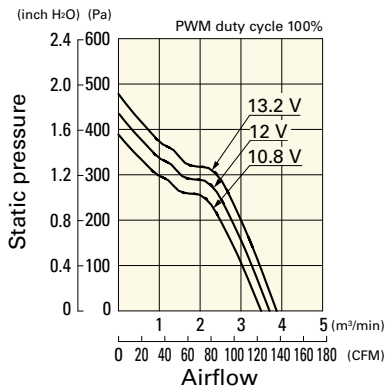

PWM duty - Speed characteristics example

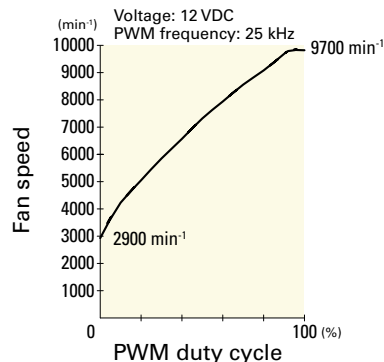

9GV0812P1F03 With pulse sensor with PWM control function

PWM duty cycle

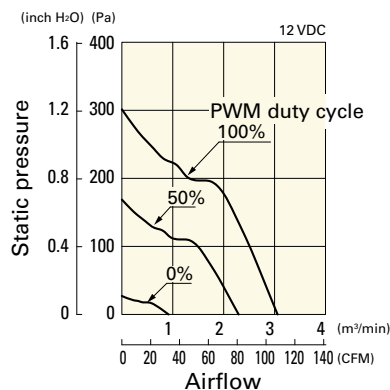

Operating voltage range

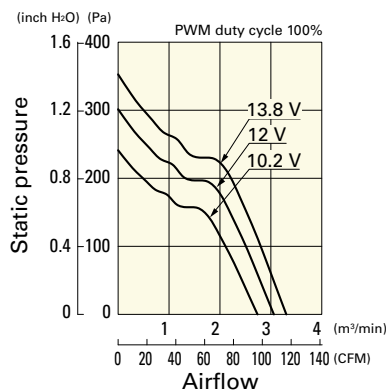

PWM duty - Speed characteristics example

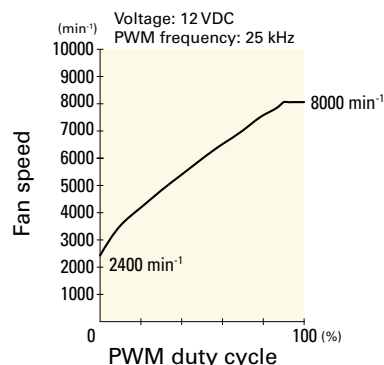

9GV0812P1M03 With pulse sensor with PWM control function

PWM duty cycle

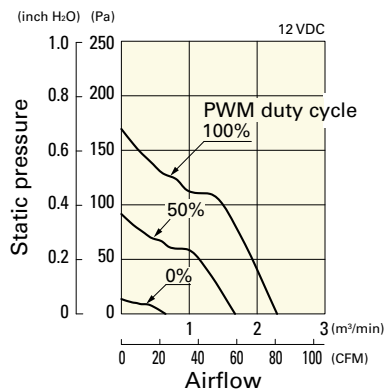

Operating voltage range

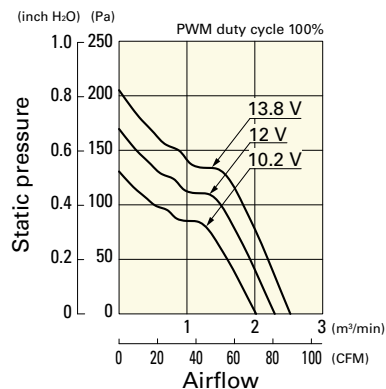

PWM duty - Speed characteristics example

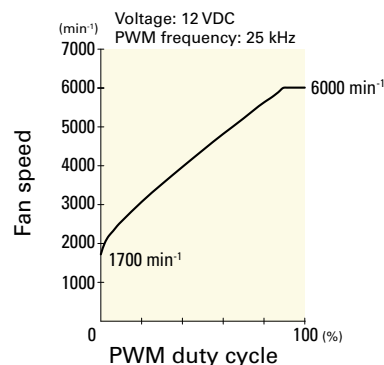

9GV0824P1G03 With pulse sensor with PWM control function

PWM duty cycle

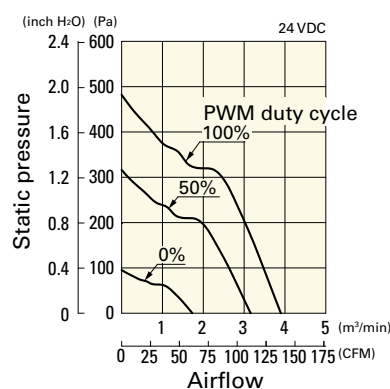

Operating voltage range

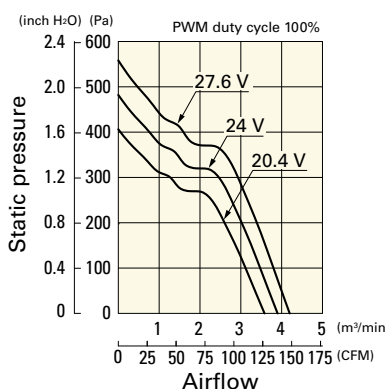

PWM duty - Speed characteristics example

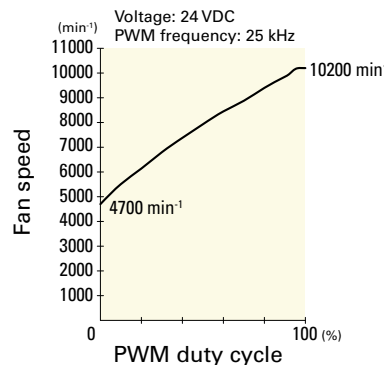

Airflow - Static Pressure Characteristics / PWM Duty - Speed Characteristics Example

9GV0848P1G03 With pulse sensor with PWM control function

PWM duty cycle

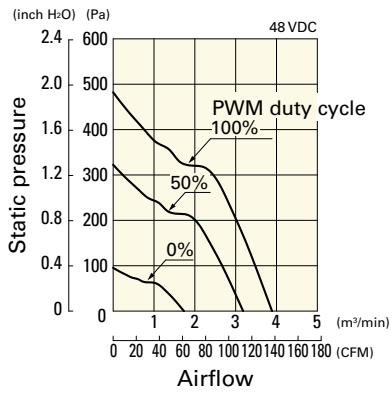

Operating voltage range

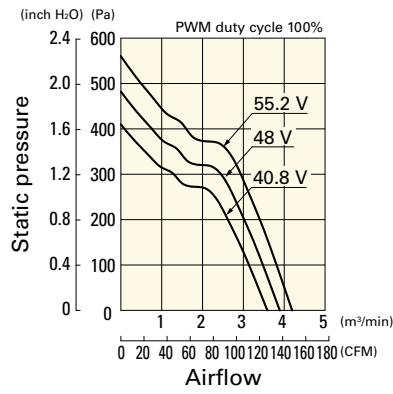

PWM duty - Speed characteristics example

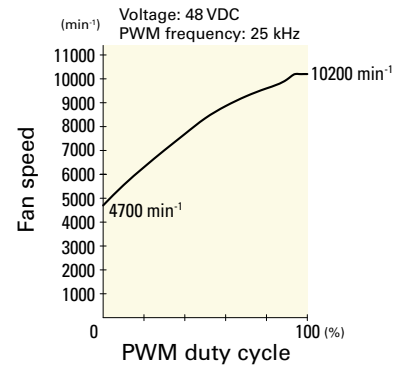

Dimensions (unit: mm) (With ribs)

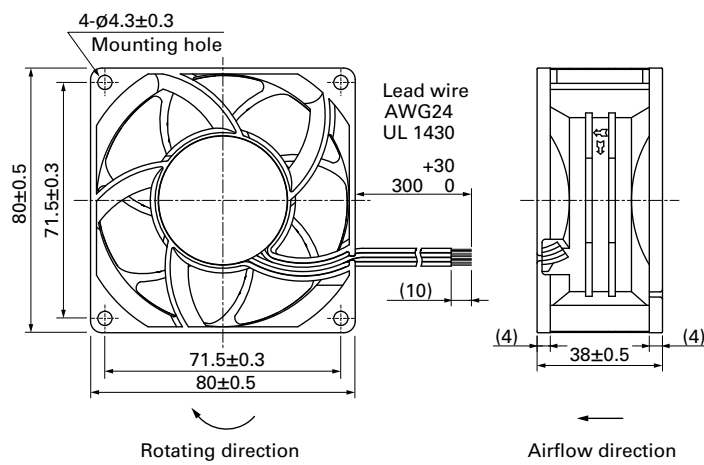

Reference Dimensions of Mounting Holes and Vent Opening (unit: mm)

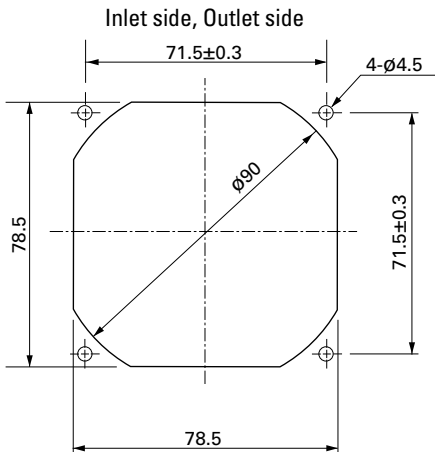

Options

Finger guards

page: p. 532

Model no.: 109-049E, 109-049H, 109-049C

Resin finger guards

page: p. 539

Model no.: 109-1002G

Resin filter kits

page: p. 540

Model no.: 109-1002F13 (13PPI), 109-1002F20 (20PPI),
109-1002F30 (30PPI), 109-1002F40 (40PPI)

Mouser Electronics

Authorized Distributor

Click to View Pricing, Inventory, Delivery & Lifecycle Information:

Sanyo Denki:

[9GV0812P1G031](#) [9GV0812P1H031](#) [9GV0812P1M03](#) [9GV0812P1G03](#) [9GV0848P1G03](#) [9GV0812P1H03](#)
[9GV0812G101](#) [9GV0812P1M031](#) [9GV0812P1F031](#) [9GV0812P1F03](#) [9GV0824P1G031](#) [9GV0824P1G03](#)
[9GV0848G101](#) [9GV0812H101](#) [9GV0812H1021](#) [9GV0812H102](#) [9GV0812G102](#) [9GV0812M102](#) [9GV0812G1021](#)
[9GV0848G102](#) [9GV0812M101](#) [9GV0848G1011](#) [9GV0812F102](#) [9GV0848P1G031](#) [9GV0812G1011](#) [9GV0812H1011](#)
[9GV0824G101](#) [9GV0824G102](#)