

# Dual/Quad Rail-to-Rail Output, Picoamp Input Precision Op Amps

## FEATURES

- **Offset Voltage: 50 $\mu$ V Max (LT1884A)**
- **Input Bias Current: 400pA Max (LT1884A)**
- **Offset Voltage Drift: 0.8 $\mu$ V/ $^{\circ}$ C Max**
- **Rail-to-Rail Output Swing**
- Operates with Single or Split Supplies
- Open-Loop Voltage Gain: 1 Million Min
- 1mA Maximum Supply Current Per Amplifier
- Slew Rate: 1V/ $\mu$ s
- Standard Pinouts

## APPLICATIONS

- Thermocouple Amplifiers
- Bridge Transducer Conditioners
- Instrumentation Amplifiers
- Battery-Powered Systems
- Photo Current Amplifiers
- Precision Integrators
- Precision Current Sources

## DESCRIPTION

The LT<sup>®</sup>1884/LT1885 op amps bring high accuracy input performance to amplifiers with rail-to-rail output swing while providing faster response than other precision amplifiers. Input offset voltage is trimmed to less than 50 $\mu$ V and the low drift maintains this accuracy over the operating temperature range. Input bias currents are an ultralow 400pA maximum.

The amplifiers work on any total power supply voltage between 2.7V and 36V (fully specified from 5V to  $\pm$ 15V). Output voltage swings to within 40mV of the negative supply and 220mV of the positive supply make these amplifiers good choices for low voltage single supply operation.

Slew rates of 1V/ $\mu$ s with a supply current of less than 1mA per amplifier give superior response and settling time performance in a low power precision amplifier.

The dual LT1884 is available with standard pinouts in 8-pin SO and PDIP packages. The quad LT1885 is also in the standard pinout 14-pin SO package.

LT, LTC and LT are registered trademarks of Linear Technology Corporation.

## TYPICAL APPLICATION

Input Fault Protected Instrumentation Amplifier

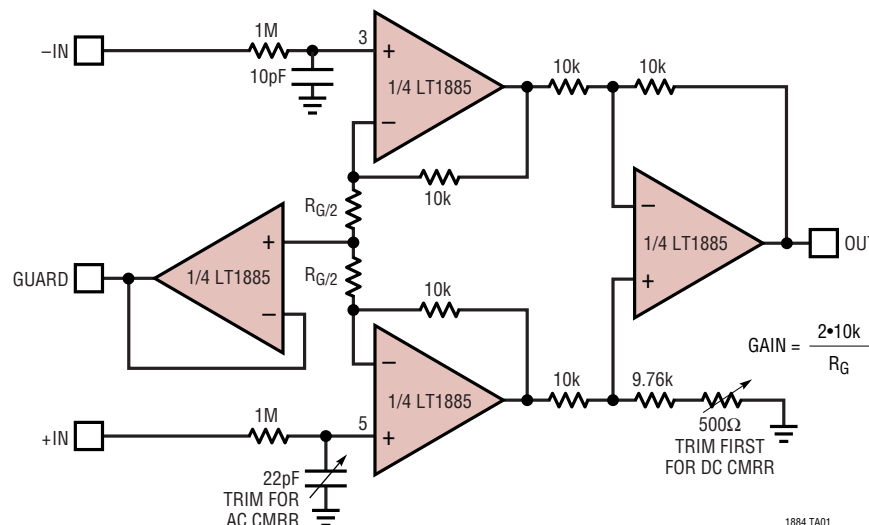

# LT1884/LT1885

## ABSOLUTE MAXIMUM RATINGS (Note 1)

Supply Voltage ( $V^+$ to $V^-$ ) .....	40V	Operating Temperature Range (Note 4) ..	$-40^{\circ}\text{C}$ to $85^{\circ}\text{C}$
Differential Input Voltage (Note 2) .....	$\pm 10\text{V}$	Specified Temperature Range (Note 5) ...	$-40^{\circ}\text{C}$ to $85^{\circ}\text{C}$
Input Voltage .....	$V^+$ to $V^-$	Maximum Junction Temperature .....	$150^{\circ}\text{C}$
Input Current (Note 2) .....	$\pm 10\text{mA}$	Storage Temperature Range .....	$-65^{\circ}\text{C}$ to $150^{\circ}\text{C}$
Output Short-Circuit Duration (Note 3) .....	Indefinite	Lead Temperature (Soldering, 10 sec) .....	$300^{\circ}\text{C}$

## PACKAGE/ORDER INFORMATION

<p>N8 PACKAGE 8-LEAD PDIP</p> <p>S8 PACKAGE 8-LEAD PLASTIC SO</p> <p><math>T_{JMAX} = 150^{\circ}\text{C}</math>, <math>\theta_{JA} = 130^{\circ}\text{C/W}</math> (N8)  <math>T_{JMAX} = 150^{\circ}\text{C}</math>, <math>\theta_{JA} = 190^{\circ}\text{C/W}</math> (S8)</p>	ORDER PART NUMBER	<p>S PACKAGE 14-LEAD PLASTIC SO</p> <p><math>T_{JMAX} = 150^{\circ}\text{C}</math>, <math>\theta_{JA} = 110^{\circ}\text{C/W}</math></p>	ORDER PART NUMBER
	LT1884CN8 LT1884CS8 LT1884ACN8 LT1884ACS8 LT1884IN8 LT1884IS8 LT1884AIN8 LT1884AIS8		LT1885CS LT1885IS
	S8 PART MARKING		
	1884    1884I 1884A    1884AI		

Consult factory for Military grade parts.

## ELECTRICAL CHARACTERISTICS

The ● denotes the specifications which apply over the full operating temperature range, otherwise specifications are at  $T_A = 25^{\circ}\text{C}$ . Single supply operation  $V_{EE} = 0$ ,  $V_{CC} = 5\text{V}$ ;  $V_{CM} = V_{CC}/2$  unless otherwise noted. (Note 5)

SYMBOL	PARAMETER	CONDITIONS	MIN	TYP	MAX	UNITS
$V_{OS}$	Input Offset Voltage (LT1884A)	$0^{\circ}\text{C} < T_A < 70^{\circ}\text{C}$	●	25	50	$\mu\text{V}$
		$-40^{\circ}\text{C} < T_A < 85^{\circ}\text{C}$	●		85	$\mu\text{V}$
					110	$\mu\text{V}$
	Input Offset Voltage (LT1884/LT1885)	$0^{\circ}\text{C} < T_A < 70^{\circ}\text{C}$	●	30	80	$\mu\text{V}$
		$-40^{\circ}\text{C} < T_A < 85^{\circ}\text{C}$	●		125	$\mu\text{V}$
					150	$\mu\text{V}$
	Input Offset Voltage Drift (Note 6)	$0^{\circ}\text{C} < T_A < 70^{\circ}\text{C}$	●	0.3	0.8	$\mu\text{V}/^{\circ}\text{C}$
		$-40^{\circ}\text{C} < T_A < 85^{\circ}\text{C}$	●	0.3	0.8	$\mu\text{V}/^{\circ}\text{C}$
$I_{OS}$	Input Offset Current (LT1884A)	$0^{\circ}\text{C} < T_A < 70^{\circ}\text{C}$	●	100	300	$\text{pA}$
		$-40^{\circ}\text{C} < T_A < 85^{\circ}\text{C}$	●		400	$\text{pA}$
					500	$\text{pA}$
	Input Offset Current (LT1884/LT1885)	$0^{\circ}\text{C} < T_A < 70^{\circ}\text{C}$	●	150	900	$\text{pA}$
		$-40^{\circ}\text{C} < T_A < 85^{\circ}\text{C}$	●		1200	$\text{pA}$
					1400	$\text{pA}$

## ELECTRICAL CHARACTERISTICS

The ● denotes the specifications which apply over the full operating temperature range, otherwise specifications are at  $T_A = 25^\circ\text{C}$ .  
 Single supply operation  $V_{EE} = 0$ ,  $V_{CC} = 5\text{V}$ ;  $V_{CM} = V_{CC}/2$  unless otherwise noted. (Note 5)

SYMBOL	PARAMETER	CONDITIONS	MIN	TYP	MAX	UNITS	
$I_B$	Input Bias Current (LT1884A)	$0^\circ\text{C} < T_A < 70^\circ\text{C}$	●	100	400	$\mu\text{A}$	
		$-40^\circ\text{C} < T_A < 85^\circ\text{C}$	●		500	$\mu\text{A}$	
	Input Bias Current (LT1884/LT1885)	$0^\circ\text{C} < T_A < 70^\circ\text{C}$	●	150	900	$\mu\text{A}$	
		$-40^\circ\text{C} < T_A < 85^\circ\text{C}$	●		1200	$\mu\text{A}$	
	Input Noise Voltage	0.1Hz to 10Hz		0.4		$\mu\text{V}_{P-P}$	
$e_n$	Input Noise Voltage Density	$f = 1\text{kHz}$		9.5		$\text{nV}/\sqrt{\text{Hz}}$	
$i_n$	Input Noise Current Density	$f = 1\text{kHz}$		0.05		$\text{pA}/\sqrt{\text{Hz}}$	
$V_{CM}$	Input Voltage Range		●	$V_{EE} + 1.0$	$V_{CC} - 1.0$	V	
			●	$V_{EE} + 1.2$	$V_{CC} - 1.2$	V	
CMRR	Common Mode Rejection Ratio	$1\text{V} < V_{CM} < 4\text{V}$	●	108	128	dB	
		$1.2\text{V} < V_{CM} < 3.8\text{V}$	●	106		dB	
PSRR	Power Supply Rejection Ratio	$V_{EE} = 0$ , $V_{CM} = 1.5\text{V}$	●	108	132	dB	
		$0^\circ\text{C} < T_A < 85^\circ\text{C}$ , $2.7\text{V} < V_{CC} < 32\text{V}$	●	108	132	dB	
	Minimum Operating Supply Voltage		●	2.4	2.7	V	
$A_{VOL}$	Large-Signal Voltage Gain	$R_L = 10\text{k}$ ; $1\text{V} < V_{OUT} < 4\text{V}$	●	500	1600	V/mV	
			●	350		V/mV	
		$R_L = 2\text{k}$ ; $1\text{V} < V_{OUT} < 4\text{V}$	●	400	800	V/mV	
			●	300		V/mV	
		$R_L = 1\text{k}$ ; $1\text{V} < V_{OUT} < 4\text{V}$	●	300	400	V/mV	
			●	200		V/mV	
$V_{OL}$	Output Voltage Swing Low	No Load	●		20	40	mV
		$I_{SINK} = 100\mu\text{A}$	●		25	50	mV
		$I_{SINK} = 1\text{mA}$	●		70	150	mV
		$I_{SINK} = 5\text{mA}$	●		270	600	mV
$V_{OH}$	Output Voltage Swing High (Referred to $V_{CC}$ )	No Load	●	120	220	mV	
		$I_{SOURCE} = 100\mu\text{A}$	●	130	230	mV	
		$I_{SOURCE} = 1\text{mA}$	●	180	300	mV	
		$I_{SOURCE} = 5\text{mA}$	●	360	600	mV	
$I_S$	Supply Current per Amplifier	$V_{CC} = 3\text{V}$	●	0.45	0.65	0.85	mA
			●			1.30	mA
		$V_{CC} = 5\text{V}$	●	0.50	0.65	0.9	mA
			●			1.4	mA
		$V_{CC} = 12\text{V}$	●	0.50	0.70	1.0	mA
			●			1.5	mA
$I_{SC}$	Short-Circuit Current	$V_{OUT}$ Short to GND	●	15	30	mA	
		$V_{OUT}$ Short to $V_{CC}$	●	15	30	mA	
GBW	Gain-Bandwidth Product	$f = 20\text{kHz}$		1.2	2	MHz	
$t_s$	Settling Time	0.01%, $V_{OUT} = 1.5\text{V}$ to $3.5\text{V}$ , $A_V = -1$ , $R_L = 2\text{k}$		10		$\mu\text{s}$	
$SR^+$	Positive Slew Rate	$A_V = -1$	●	0.45	0.9	V/ $\mu\text{s}$	
			●	0.36		V/ $\mu\text{s}$	
$SR^-$	Negative Slew Rate	$A_V = -1$	●	0.35	0.7	V/ $\mu\text{s}$	
			●	0.25		V/ $\mu\text{s}$	

## ELECTRICAL CHARACTERISTICS

The ● denotes the specifications which apply over the full operating temperature range, otherwise specifications are at  $T_A = 25^\circ\text{C}$ .  
 Single supply operation  $V_{EE} = 0$ ,  $V_{CC} = 5\text{V}$ ;  $V_{CM} = V_{CC}/2$  unless otherwise noted. (Note 5)

SYMBOL	PARAMETER	CONDITIONS	MIN	TYP	MAX	UNITS
$\Delta V_{OS}$	Offset Voltage Match (LT1884A)	$0^\circ\text{C} < T_A < 70^\circ\text{C}$	●	30	70	$\mu\text{V}$
		$-40^\circ\text{C} < T_A < 85^\circ\text{C}$	●		125	$\mu\text{V}$
	Offset Voltage Match (LT1884/LT1885)	(Note 7) $0^\circ\text{C} < T_A < 70^\circ\text{C}$ $-40^\circ\text{C} < T_A < 85^\circ\text{C}$	● ●	35	125	$\mu\text{V}$ $\mu\text{V}$ $\mu\text{V}$
	Offset Voltage Match Drift	(Notes 6, 7)	●	0.4	1.2	$\mu\text{V}/^\circ\text{C}$
$\Delta I_{B+}$	Noninverting Bias Current Match (LT1884A)	$0^\circ\text{C} < T_A < 70^\circ\text{C}$	●	200	600	$\text{pA}$
		$-40^\circ\text{C} < T_A < 85^\circ\text{C}$	●		700	$\text{pA}$
	Noninverting Bias Current Match (LT1884/LT1885)	(Notes 7, 9) $0^\circ\text{C} < T_A < 70^\circ\text{C}$ $-40^\circ\text{C} < T_A < 85^\circ\text{C}$	● ●	250	1200	$\text{pA}$ $\text{pA}$ $\text{pA}$
$\Delta\text{CMRR}$	Common Mode Rejection Match	(Notes 7, 9)	●	104	125	dB
$\Delta\text{PSRR}$	Positive Power Supply Rejection Match (Notes 7, 9)	$V_{EE} = 0$ , $V_{CM} = 1.5\text{V}$ $0^\circ\text{C} < T_A < 85^\circ\text{C}$ , $2.7\text{V} < V_{CC} < 32\text{V}$	●	104	126	dB
		$T_A = -40^\circ\text{C}$ , $3\text{V} < V_{CC} < 32\text{V}$	●	104	126	dB

The ● denotes the specifications which apply over the full operating temperature range, otherwise specifications are at  $T_A = 25^\circ\text{C}$ .  
 Split supply operation  $V_S = \pm 15\text{V}$ ;  $V_{CM} = 0\text{V}$  unless otherwise noted. (Note 5)

SYMBOL	PARAMETER	CONDITIONS	MIN	TYP	MAX	UNITS
$V_{OS}$	Input Offset Voltage (LT1884A)	$0^\circ\text{C} < T_A < 70^\circ\text{C}$	●	25	50	$\mu\text{V}$
		$-40^\circ\text{C} < T_A < 85^\circ\text{C}$	●		85	$\mu\text{V}$
	Input Offset Voltage (LT1884/LT1885)	$0^\circ\text{C} < T_A < 70^\circ\text{C}$ $-40^\circ\text{C} < T_A < 85^\circ\text{C}$	● ●	30	80	$\mu\text{V}$ $\mu\text{V}$ $\mu\text{V}$
	Input Offset Voltage Drift (Note 6)	$0^\circ\text{C} < T_A < 70^\circ\text{C}$ $-40^\circ\text{C} < T_A < 85^\circ\text{C}$	● ●	0.3	0.8	$\mu\text{V}/^\circ\text{C}$ $\mu\text{V}/^\circ\text{C}$
$I_{OS}$	Input Offset Current (LT1884A)	$0^\circ\text{C} < T_A < 70^\circ\text{C}$	●	150	300	$\text{pA}$
		$-40^\circ\text{C} < T_A < 85^\circ\text{C}$	●		400	$\text{pA}$
	Input Offset Current (LT1884/LT1885)	$0^\circ\text{C} < T_A < 70^\circ\text{C}$ $-40^\circ\text{C} < T_A < 85^\circ\text{C}$	● ●	150	900	$\text{pA}$ $\text{pA}$ $\text{pA}$
$I_B$	Input Bias Current (LT1884A)	$0^\circ\text{C} < T_A < 70^\circ\text{C}$	●	150	400	$\text{pA}$
		$-40^\circ\text{C} < T_A < 85^\circ\text{C}$	●		500	$\text{pA}$
	Input Bias Current (LT1884/LT1885)	$0^\circ\text{C} < T_A < 70^\circ\text{C}$ $-40^\circ\text{C} < T_A < 85^\circ\text{C}$	● ●	150	900	$\text{pA}$ $\text{pA}$ $\text{pA}$
	Input Noise Voltage	0.1Hz to 10Hz		0.4		$\mu\text{V}_{P-P}$
$e_n$	Input Noise Voltage Density	$f = 1\text{kHz}$		9.5		$\text{nV}/\sqrt{\text{Hz}}$
$i_n$	Input Noise Current Density	$f = 1\text{kHz}$		0.05		$\text{pA}/\sqrt{\text{Hz}}$
$V_{CM}$	Input Voltage Range		●	$V_{EE} + 1.0$	$V_{CC} - 1.0$	V
			●	$V_{EE} + 1.2$	$V_{CC} - 1.2$	V
CMRR	Common Mode Rejection Ratio	$-13.5\text{V} < V_{CM} < 13.5\text{V}$	●	114	130	dB

## ELECTRICAL CHARACTERISTICS

The ● denotes the specifications which apply over the full operating temperature range, otherwise specifications are at  $T_A = 25^\circ\text{C}$ . Split supply operation  $V_S = \pm 15\text{V}$ ;  $V_{\text{CM}} = 0\text{V}$  unless otherwise noted. (Note 5)

SYMBOL	PARAMETER	CONDITIONS		MIN	TYP	MAX	UNITS
+PSRR	Positive Power Supply Rejection Ratio	$V_{\text{EE}} = -15\text{V}$ , $V_{\text{CM}} = 0\text{V}$ ; $1.5\text{V} < V_{\text{CC}} < 18\text{V}$	●	114	132		dB
-PSRR	Negative Power Supply Rejection Ratio	$V_{\text{CC}} = 15\text{V}$ , $V_{\text{CM}} = 0\text{V}$ ; $-1.5\text{V} < V_{\text{EE}} < -18\text{V}$	●	106	132		dB
	Minimum Operating Supply Voltage		●		$\pm 1.2$	$\pm 1.35$	V
$A_{\text{VOL}}$	Large-Signal Voltage Gain	$R_L = 10\text{k}$ ; $-13.5\text{V} < V_{\text{OUT}} < 13.5\text{V}$	●	1000	1600		V/mV
			●	700			V/mV
		$R_L = 2\text{k}$ ; $-13.5\text{V} < V_{\text{OUT}} < 13.5\text{V}$	●	250	420		V/mV
		$R_L = 1\text{k}$ ; $-12\text{V} < V_{\text{OUT}} < 12\text{V}$	●	175			V/mV
			●	100	230		V/mV
			●	75			V/mV
$V_{\text{OL}}$	Output Voltage Swing Low (Referred to $V_{\text{EE}}$ )	No Load	●		20	40	mV
		$I_{\text{SINK}} = 100\mu\text{A}$	●		25	50	mV
		$I_{\text{SINK}} = 1\text{mA}$	●		70	150	mV
		$I_{\text{SINK}} = 5\text{mA}$	●		270	600	mV
$V_{\text{OH}}$	Output Voltage Swing High (Referred to $V_{\text{CC}}$ )	No Load	●		160	220	mV
		$I_{\text{SOURCE}} = 100\mu\text{A}$	●		160	230	mV
		$I_{\text{SOURCE}} = 1\text{mA}$	●		180	300	mV
		$I_{\text{SOURCE}} = 5\text{mA}$	●		360	600	mV
$I_S$	Supply Current Per Amplifier	$V_S = \pm 15\text{V}$	●		0.85	1.1	mA
			●			1.6	mA
$I_{\text{SC}}$	Short-Circuit Current	$V_{\text{OUT}}$ Short to $V_{\text{EE}}$	●	15	50		mA
		$V_{\text{OUT}}$ Short to $V_{\text{CC}}$	●	15	30		mA
GBW	Gain-Bandwidth Product	$f = 20\text{kHz}$		1.5	2.2		MHz
$t_S$	Settling Time	0.01%, $V_{\text{OUT}} = -5\text{V}$ to $5\text{V}$ , $A_V = -1$ , $R_L = 2\text{k}$			17		$\mu\text{s}$
$\text{SR}^+$	Positive Slew Rate	$A_V = -1$	●	0.5	1.0		V/ $\mu\text{s}$
			●	0.4			V/ $\mu\text{s}$
$\text{SR}^-$	Negative Slew Rate	$A_V = -1$	●	0.40	0.7		V/ $\mu\text{s}$
			●	0.26			V/ $\mu\text{s}$
$\Delta V_{\text{OS}}$	Offset Voltage Match (LT1884A)	(Note 7)			35	70	$\mu\text{V}$
		$0^\circ\text{C} < T_A < 70^\circ\text{C}$	●			125	$\mu\text{V}$
	$-40^\circ\text{C} < T_A < 85^\circ\text{C}$	●				160	$\mu\text{V}$
	Offset Voltage Match (LT1884/LT1885)	(Note 7)			35	125	$\mu\text{V}$
		$0^\circ\text{C} < T_A < 70^\circ\text{C}$	●			175	$\mu\text{V}$
		$-40^\circ\text{C} < T_A < 85^\circ\text{C}$	●			235	$\mu\text{V}$
	Offset Voltage Match Drift	(Note 6, 7)	●		0.4	1.1	$\mu\text{V}/^\circ\text{C}$
$\Delta I_B^+$	Noninverting Bias Current Match (LT1884A)	(Notes 7, 8)			200	600	pA
		$0^\circ\text{C} < T_A < 70^\circ\text{C}$	●			700	pA
		$-40^\circ\text{C} < T_A < 85^\circ\text{C}$	●				850
	Noninverting Bias Current Match (LT1884/LT1885)	(Notes 7, 8)			240	1200	pA
		$0^\circ\text{C} < T_A < 70^\circ\text{C}$	●			1600	pA
		$-40^\circ\text{C} < T_A < 85^\circ\text{C}$	●			1900	pA
$\Delta\text{CMRR}$	Common Mode Rejection Match	(Notes 7, 9)	●	106	125		dB
$\Delta +\text{PSRR}$	Positive Power Supply Rejection Match	$V_{\text{EE}} = -15\text{V}$ , $V_{\text{CM}} = 0\text{V}$ , $1.5\text{V} < V_{\text{CC}} < 18\text{V}$ , (Notes 7, 9)	●	108	124		dB
$\Delta -\text{PSRR}$	Negative Power Supply Rejection Match	$V_{\text{CC}} = 15\text{V}$ , $V_{\text{CM}} = 0\text{V}$ , $-1.5\text{V} < V_{\text{EE}} < -18\text{V}$ , (Notes 7, 9)	●	102	132		dB

## ELECTRICAL CHARACTERISTICS

**Note 1:** Absolute Maximum Ratings are those values beyond which the life of the device may be impaired.

**Note 2:** The inputs are protected by back-to-back diodes. If the differential input voltage exceeds 0.7V, the input current should be limited to less than 10mA.

**Note 3:** A heat sink may be required to keep the junction temperature below absolute maximum.

**Note 4:** The LT1884C/LT1885C and LT1884I/LT1885I are guaranteed functional over the operating temperature range of  $-40^{\circ}\text{C}$  to  $85^{\circ}\text{C}$ .

**Note 5:** The LT1884C/LT1885C are designed, characterized and expected to meet specified performance from  $-40^{\circ}\text{C}$  to  $85^{\circ}\text{C}$  but are not tested or QA sampled at these temperatures. LT1884I is guaranteed to meet specified performance from  $-40^{\circ}\text{C}$  to  $85^{\circ}\text{C}$ .

**Note 6:** This parameter is not 100% tested.

**Note 7:** Matching parameters are the difference between amplifiers A and B in the LT1884 and between amplifiers A and D and B and C in the LT1885.

**Note 8:** This parameter is the difference between the two noninverting input bias currents.

**Note 9:**  $\Delta\text{CMRR}$  and  $\Delta\text{PSRR}$  are defined as follows: CMRR and PSRR are measured in  $\mu\text{V}/\text{V}$  on each amplifier. The difference is calculated in  $\mu\text{V}/\text{V}$  and then converted to dB.

## TYPICAL PERFORMANCE CHARACTERISTICS

Distribution of Offset Voltage Drift

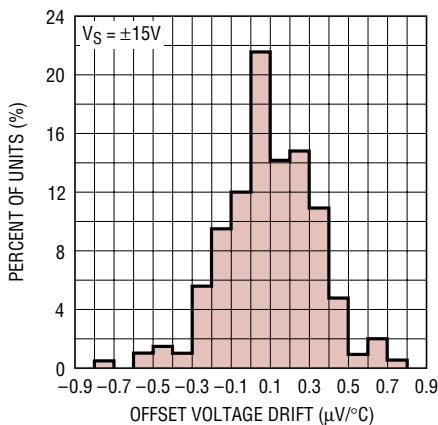

18845 G01

Input Offset Voltage vs Temperature

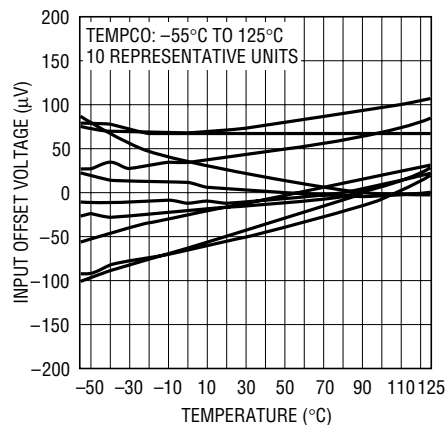

18845 G02

$V_{\text{OUT}}$  vs  $I_{\text{SINK}}$

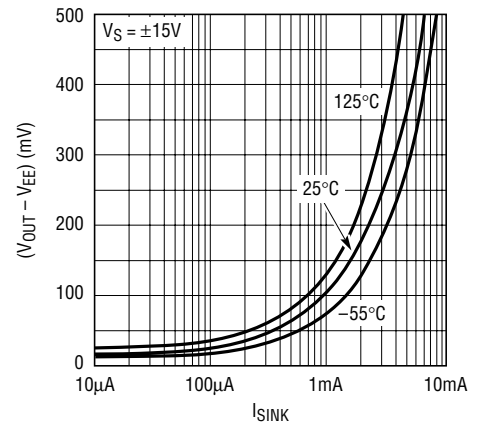

18845 G03

$V_{\text{OUT}}$  vs  $I_{\text{SOURCE}}$

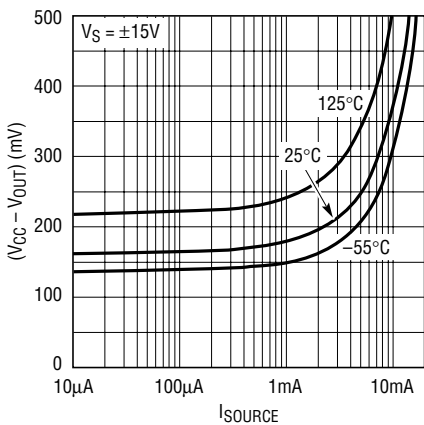

18845 G04

Gain vs Frequency

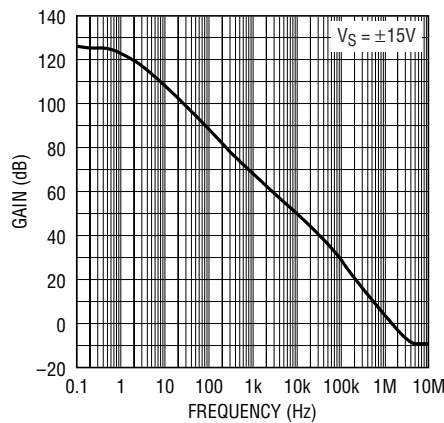

18845 G05

Gain, Phase Shift vs Frequency

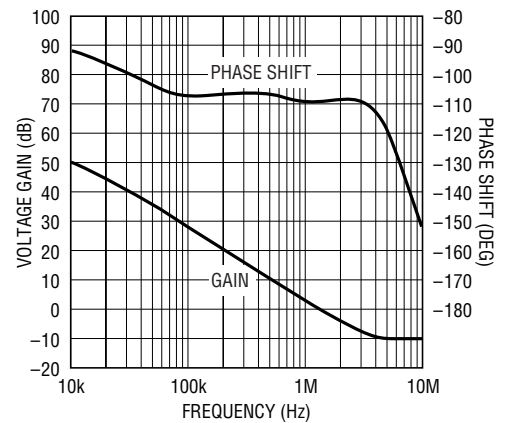

18845 G06

# TYPICAL PERFORMANCE CHARACTERISTICS

CMRR vs Frequency

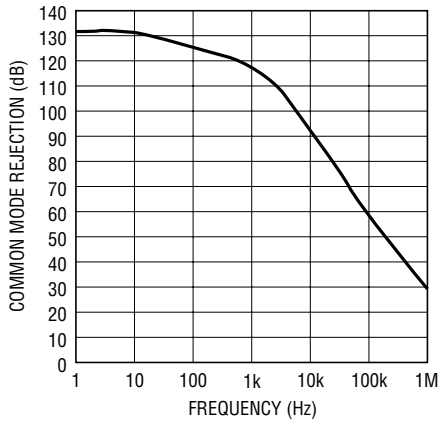

18845 G07

PSRR vs Frequency

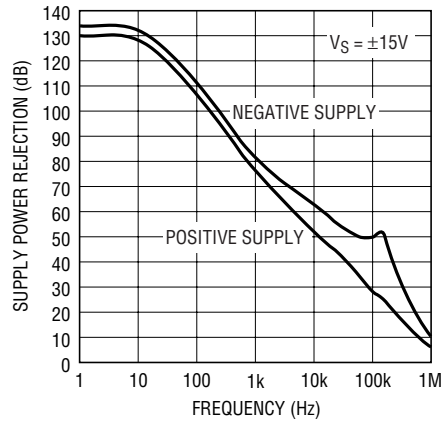

18845 G08

$V_n, I_n$  vs Frequency

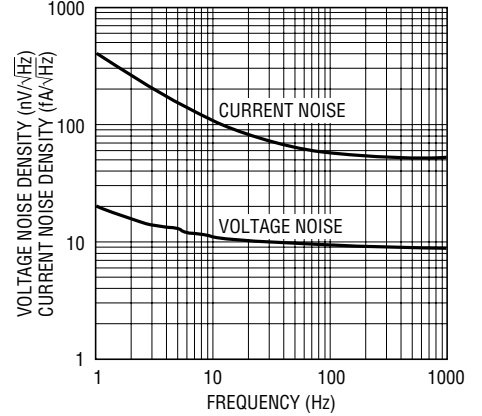

18845 G09

0.1Hz to 10Hz Noise

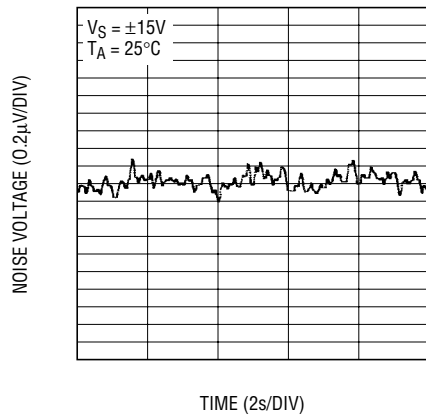

18845 G10

0.01Hz to 1Hz Noise

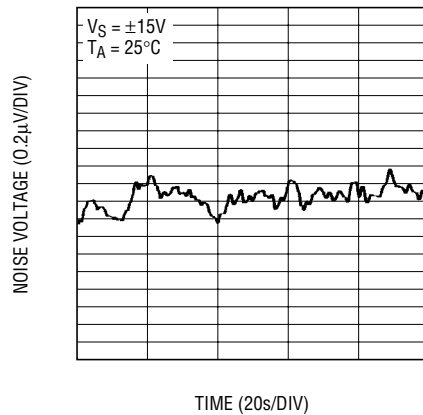

18845 G11

Slew Rate vs Temperature

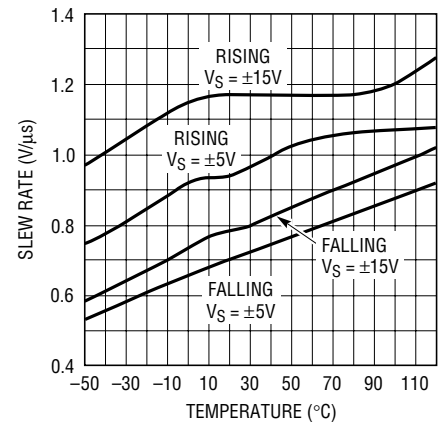

18845 G12

Settling Time to 0.01% vs Output Step

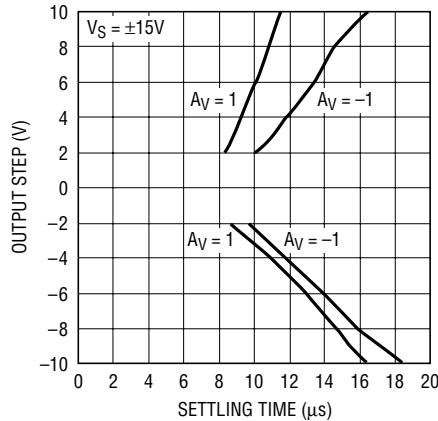

18845 G13

Supply Current per Amplifier vs Supply Voltage

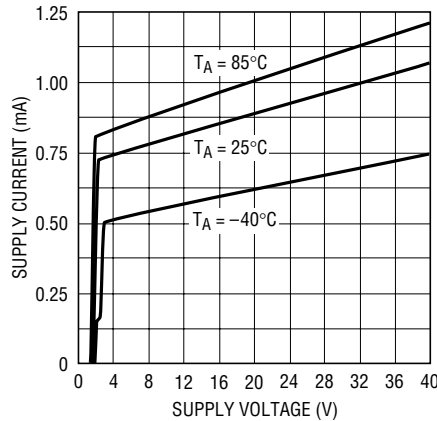

18845 G14

Input Bias Current vs Common Mode Voltage

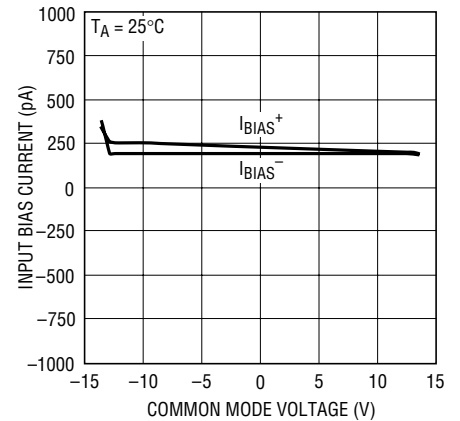

LTXXXX • TPCXX

# TYPICAL PERFORMANCE CHARACTERISTICS

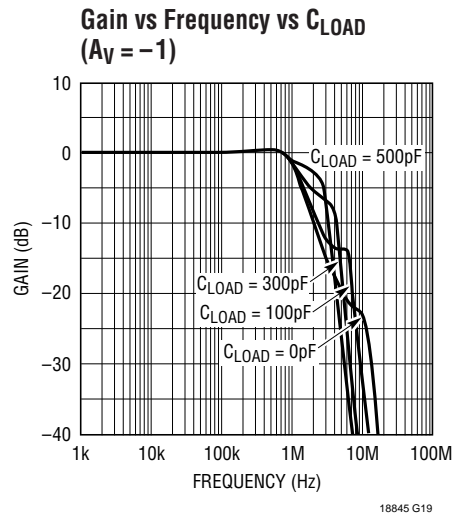
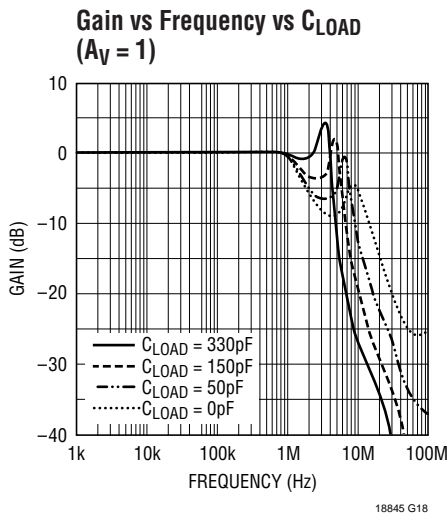
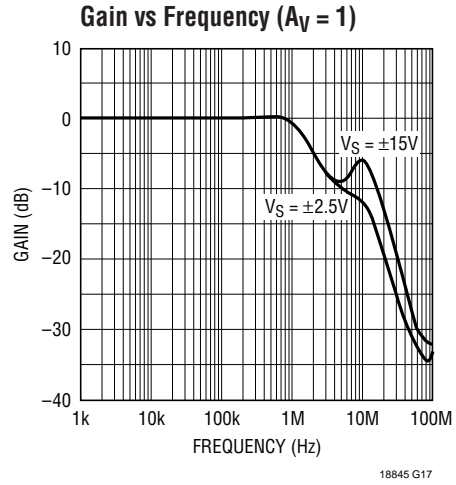
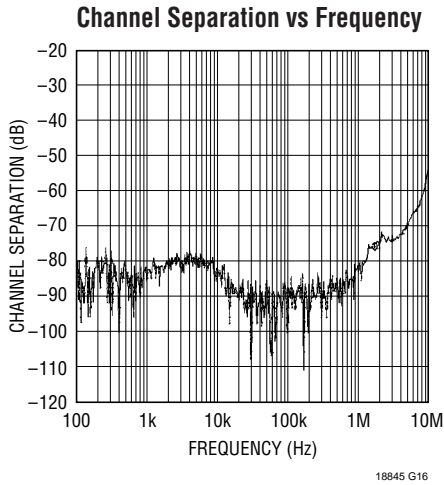

**Large-Signal Response**

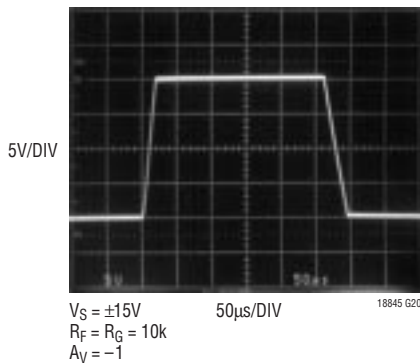

**Small-Signal Response**

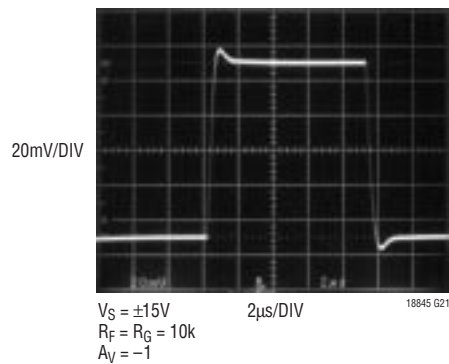



## APPLICATIONS INFORMATION

The LT1884/LT1885 dual op amp features exceptional input precision with rail-to-rail output swing. Slew rate and small-signal bandwidth are superior to other amplifiers with comparable input precision. These characteristics make the LT1884/LT1885 a convenient choice for precision low voltage systems and for improved AC performance in higher voltage precision systems. Maintaining the advantage of the precision inherent in the amplifier depends upon proper applications circuit design and board layout.

### Preserving Input Precision

Preserving the input voltage accuracy of the LT1884/LT1885 requires that the applications circuit and PC board layout do not introduce errors comparable to or greater than the 30 $\mu$ V offset. Temperature differentials across the input connections can generate thermocouple voltages of 10s of microvolts. PC board layouts should keep connections to the amplifier's input pins close together and away from heat dissipating components. Air currents across the board can also generate temperature differentials.

The extremely low input bias currents, 100pA, allow high accuracy to be maintained with high impedance sources and feedback networks. The LT1884/LT1885's low input bias currents are obtained by using a cancellation circuit on-chip. This causes the resulting  $I_{BIAS}^+$  and  $I_{BIAS}^-$  to be uncorrelated, as implied by the  $I_{OS}$  specification being comparable to the  $I_{BIAS}$ . The user should not try to balance the input resistances in each input lead, as is commonly recommended with most amplifiers. The impedance at either input should be kept as small as possible to minimize total circuit error.

PC board layout is important to ensure that leakage currents do not corrupt the low  $I_{BIAS}$  of the amplifier. In high precision, high impedance circuits, the input pins should be surrounded by a guard ring of PC board

interconnect, with the guard driven to the same common mode voltage as the amplifier inputs.

### Input Common Mode Range

The LT1884/LT1885 output is able to swing close to each power supply rail, but the input stage is limited to operating between  $V_{EE} + 0.8V$  and  $V_{CC} - 0.9V$ . Exceeding this common mode range will cause the gain to drop to zero; however, no gain reversal will occur.

### Input Protection

The inverting and noninverting input pins of the LT1884/LT1885 have limited on-chip protection. ESD protection is provided to prevent damage during handling. The input transistors have voltage clamping and limiting resistors to protect against input differentials up to 10V. Short transients above this level will also be tolerated. If the input pins may be subject to a sustained differential voltage above 10V, external limiting resistors should be used to prevent damage to the amplifier. A 1k resistor in each input lead will provide protection against a 30V differential voltage.

### Capacitive Loads

The LT1884/LT1885 can drive capacitive loads up to 300pF when configured for unity gain. The capacitive load driving capability increases as the amplifier is used in higher gain configurations. Capacitive load driving may also be increased by decoupling the capacitance from the output with a small resistance.

### Input Bias Currents

While it may be tempting to seek out a JFET amplifier for low input bias current, remember that bipolar devices improve with temperature while JFETs degrade.

**PACKAGE DESCRIPTION**

Dimensions in inches (millimeters) unless otherwise noted.

**N8 Package**  
**8-Lead PDIP (Narrow 0.300)**  
 (LTC DWG # 05-08-1510)

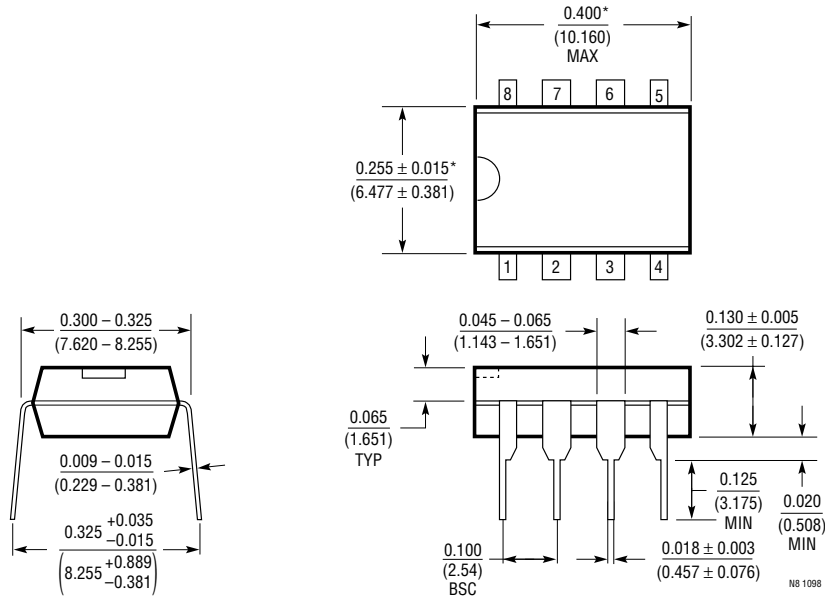

\*THESE DIMENSIONS DO NOT INCLUDE MOLD FLASH OR PROTRUSIONS.  
 MOLD FLASH OR PROTRUSIONS SHALL NOT EXCEED 0.010 INCH (0.254mm)

**S8 Package**  
**8-Lead Plastic Small Outline (Narrow 0.150)**  
 (LTC DWG # 05-08-1610)

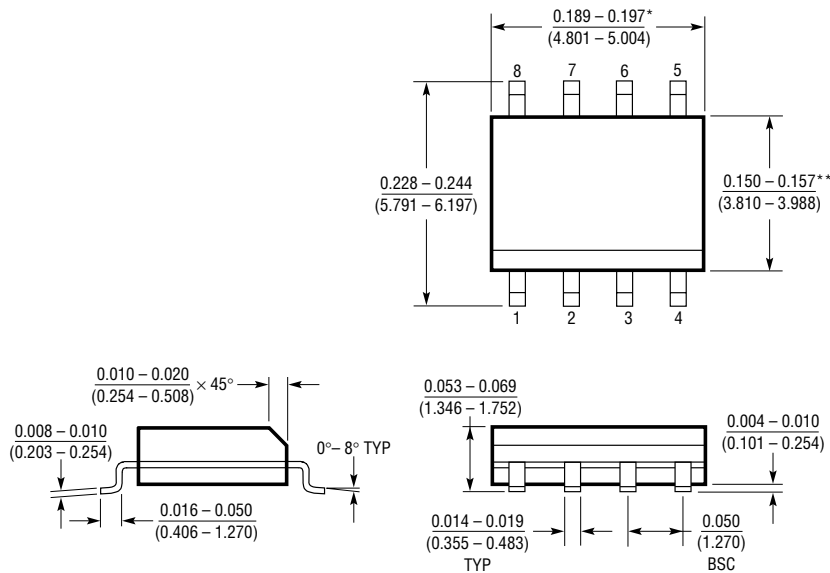

\* DIMENSION DOES NOT INCLUDE MOLD FLASH. MOLD FLASH SHALL NOT EXCEED 0.006" (0.152mm) PER SIDE

\*\* DIMENSION DOES NOT INCLUDE INTERLEAD FLASH. INTERLEAD FLASH SHALL NOT EXCEED 0.010" (0.254mm) PER SIDE

508 1298

**PACKAGE DESCRIPTION** Dimensions in inches (millimeters) unless otherwise noted.

**S Package**  
**14-Lead Plastic Small Outline (Narrow 0.150)**  
 (LTC DWG # 05-08-1610)

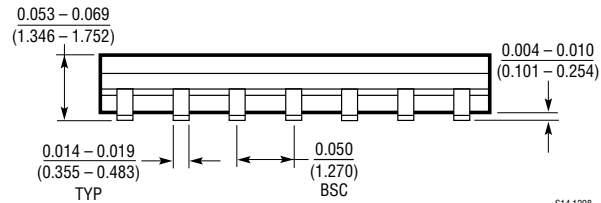
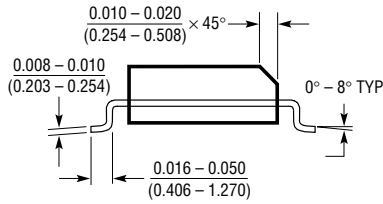
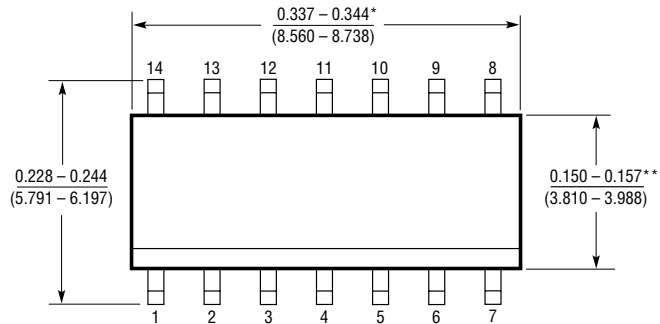

\*DIMENSION DOES NOT INCLUDE MOLD FLASH. MOLD FLASH SHALL NOT EXCEED 0.006" (0.152mm) PER SIDE  
 \*\*DIMENSION DOES NOT INCLUDE INTERLEAD FLASH. INTERLEAD FLASH SHALL NOT EXCEED 0.010" (0.254mm) PER SIDE

S14 1298

## TYPICAL APPLICATION

### 16-Bit Voltage Output DAC on $\pm 5V$ Supply

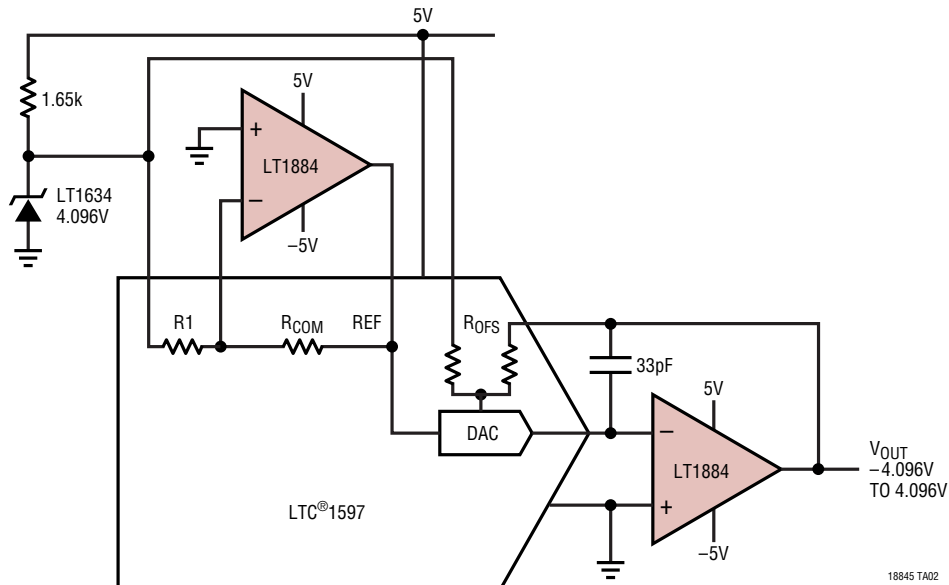

## RELATED PARTS

PART NUMBER	DESCRIPTION	COMMENTS
LT1112	Dual Picoamp Input Op Amp	$V_{OS} = 60\mu V$ Max
LT1114	Quad Picoamp Input Op Amp	$V_{OS} = 60\mu V$ Max
LT1167	Gain Programmable Instrumentation Amp	Gain Error = 0.08% Max
LT1490	Micropower Rail-to-Rail Input and Output Op Amp	Over-The-Top™ Common Mode Range
LT1793	Low Noise JFET Op Amp	$I_B = 10pA$ Max
LT1881/LT1882	Picoamp Input Rail-to-Rail Output Op Amp	Lower Input Bias Currents Than LT1884/LT1885
LTC2050	Zero Drift Op Amp in SOT-23	$V_{OS} = 3\mu V$ Max, Rail-to-Rail Output

Over-The-Top is a trademark of Linear Technology Corporation.

# Mouser Electronics

Authorized Distributor

Click to View Pricing, Inventory, Delivery & Lifecycle Information:

## Analog Devices Inc.:

[LT1884ACN8](#) [LT1884AIS8#TR](#) [LT1884AIN8#PBF](#) [LT1884IS8#TRPBF](#) [LT1884IS8](#) [LT1884IS8#PBF](#)  
[LT1884CN8#PBF](#) [LT1884ACS8#PBF](#) [LT1884ACN8#PBF](#) [LT1885IS#TRPBF](#) [LT1884AIS8#TRPBF](#) [LT1884CS8](#)  
[LT1884ACS8#TR](#) [LT1884CS8#TRPBF](#) [LT1885CS#PBF](#) [LT1884ACS8](#) [LT1884ACS8#TRPBF](#) [LT1884CS8#PBF](#)  
[LT1884AIN8](#) [LT1885IS#PBF](#) [LT1884CS8#TR](#) [LT1885CS#TR](#) [LT1884IN8](#) [LT1884AIS8](#) [LT1885IS](#) [LT1884IN8#PBF](#)  
[LT1884AIS8#PBF](#) [LT1885IS#TR](#) [LT1884CN8](#) [LT1884IS8#TR](#) [LT1885CS#TRPBF](#) [LT1885CS](#)