

PLEASE CHECK WWW.MOLEX.COM FOR LATEST PART INFORMATION

Part Number: [0554820419](#)
Status: **Active**
Overview: Mini Mi II™ Wire Harness
Description: 1.25mm Pitch Mini Mi II Wire-to-Wire Adapter, 4 Circuits

Documents:

[3D Model](#) [Product Specification PS-55482-006-001 \(PDF\)](#)
[Drawing \(PDF\)](#) [RoHS Certificate of Compliance \(PDF\)](#)

General

Product Family	Accessories
Series	55482
Comments	For Panel Mounting
Component Type	Adapter
Overview	Mini Mi II™ Wire Harness
Product Name	Mini Mi II
UPC	822348170845

Physical

Circuits (Loaded)	4
Circuits (maximum)	4
Color - Resin	Natural
Gender	Male
Material - Metal	Brass
Material - Plating Mating	Tin
Material - Plating Termination	Tin
Material - Resin	Nylon
Net Weight	438.100/mg
Number of Rows	1
Packaging Type	Bag
Plating min - Mating	1.016µm
Plating min - Termination	1.016µm
Temperature Range - Operating	-20° to +80°C

Electrical

Current - Maximum per Contact	1.5A
-------------------------------	------

Material Info

Reference - Drawing Numbers

Product Specification	PS-55482-006-001
Sales Drawing	SD-55482-004

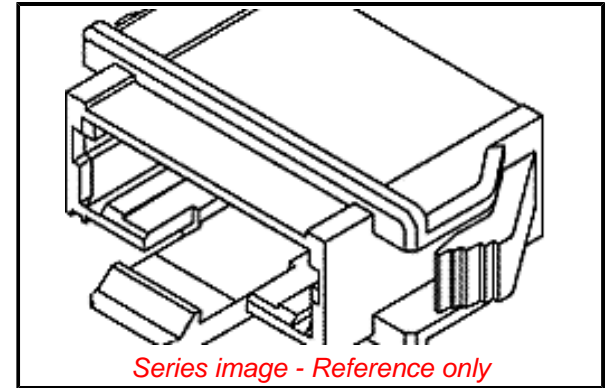

EU ELV

Not Relevant

EU RoHS

Compliant

REACH SVHC

Not Contained Per -
ED/61/2018 (27 June
2018)

Halogen-Free

Status

Low-Halogen

**Need more information on product
environmental compliance?**

Email productcompliance@molex.com
Please visit the [Contact Us](#) section for any
non-product compliance questions.

China ROHS	Green Image
ELV	Not Relevant
RoHS Phthalates	Not Contained

Search Parts in this Series

[55482 Series](#)

Use With

[54596](#)

Mouser Electronics

Authorized Distributor

Click to View Pricing, Inventory, Delivery & Lifecycle Information:

[Molex:](#)

[55482-0419](#)