



# FOD8160

## High Noise Immunity, 3.3 V / 5 V, 10 Mbit/sec, Logic Gate Optocoupler in Wide-Body SOP 5-Pin

### Features

- Optoplanar® Packaging Technology Allows More Than 10 mm Creepage and Clearance Distance, and 0.5 mm Insulation Distance to Achieve Reliable and High Voltage Insulation
- High Noise Immunity Characterized by Common Mode Transient Immunity (CMTI)
  - 20 kV/ $\mu$ s Minimum CMTI
- Specifications Guaranteed Over 3 V to 5.5 V Supply Voltage and -40°C to 100°C Extended Industrial Temperature Range
- High-Speed, 10 Mbit/s Data Rate (NRZ)
- Safety and Regulatory Approvals
  - UL1577, 5,000 VAC<sub>RMS</sub> for 1 Minute
  - DIN-EN/IEC60747-5-5, 1,414 V Peak Working Insulation Voltage

### Applications

- Isolating Intelligent Power Module
- Isolating Industrial Communication Interface

### Related Resources

- [www.fairchildsemi.com/products/opto/](http://www.fairchildsemi.com/products/opto/)
- [www.fairchildsemi.com/pf/FO/FODM8061.html](http://www.fairchildsemi.com/pf/FO/FODM8061.html)
- [www.fairchildsemi.com/pf/FO/FODM611.html](http://www.fairchildsemi.com/pf/FO/FODM611.html)

### Description

The FOD8160 is a 3.3 V / 5 V high-speed logic gate optocoupler with open-collector output, which supports isolated communications to allow digital signals to communicate between systems without conducting ground loops or hazardous voltages. The device utilizes Fairchild's proprietary Optoplanar® coplanar packaging technology and optimized IC design to achieve high-noise immunity, characterized by high common-mode rejection specifications.

The FOD8160, packaged in a wide-body SOP 5-Pin package, consists of an aluminium gallium arsenide (AlGaAs) LED and an integrated high-speed photodetector. The output of the detector IC is an open collector Schottky-clamped transistor. The electrical and switching characteristics are guaranteed over the extended industrial temperature range of -40°C to 100°C and a  $V_{CC}$  range of 3 V to 5.5 V.

### Functional Schematic

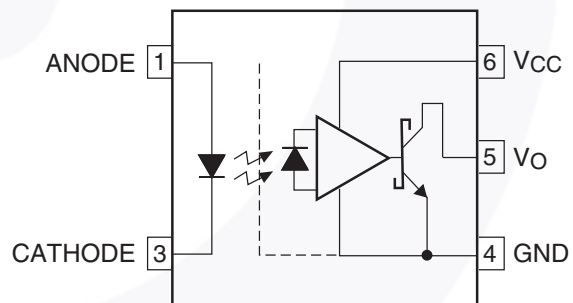


Figure 1. Functional Schematic

### Truth Table

| LED | Output |
|-----|--------|
| Off | HIGH   |
| On  | LOW    |

### Pin Configuration

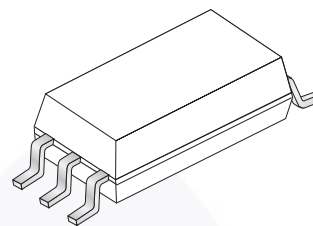
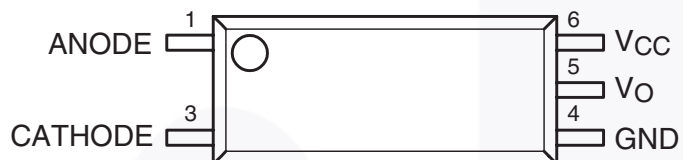


Figure 2. Pin Configuration

### Pin Definitions

| Pin # | Name            | Description           |
|-------|-----------------|-----------------------|
| 1     | Anode           | Anode                 |
| 3     | Cathode         | Cathode               |
| 4     | GND             | Output Ground         |
| 5     | V <sub>O</sub>  | Output Voltage        |
| 6     | V <sub>CC</sub> | Output Supply Voltage |

## Safety and Insulation Ratings

As per DIN EN/IEC60747-5-5, this optocoupler is suitable for “safe electrical insulation” only within the safety limit data below. Compliance with the safety ratings shall be ensured by means of protective circuits.

| Symbol                | Parameter  | Min.            | Typ.      | Max. | Unit              |
|-----------------------|--|-----------------|-----------|------|-------------------|
|                       | Installation Classifications per DIN VDE 0110/1.89 Table 1   |                 |           |      |                   |
|                       | For Rated Mains Voltage < 150 V <sub>RMS</sub>   |                 | I-IV      |      |                   |
|                       | For Rated Mains Voltage < 300 V <sub>RMS</sub>   |                 | I-IV      |      |                   |
|                       | For Rated Mains Voltage < 450 V <sub>RMS</sub>   |                 | I-IV      |      |                   |
|                       | For Rated Mains Voltage < 600 V <sub>RMS</sub>   |                 | I-IV      |      |                   |
|                       | Climatic Classification  |                 | 40/100/21 |      |                   |
|                       | Pollution Degree (DIN VDE 0110/1.89)   |                 | 2         |      |                   |
| CTI                   | Comparative Tracking Index   | 175             |           |      |                   |
| V <sub>PR</sub>       | Input to Output Test Voltage, Method b, V <sub>IORM</sub> × 1.875 = V <sub>PR</sub> , 100% Production Test with t <sub>m</sub> = 1 s, Partial Discharge < 5 pC | 2651            |           |      | V <sub>peak</sub> |
|                       | Input to Output Test Voltage, Method a, V <sub>IORM</sub> × 1.6 = V <sub>PR</sub> , Type and Sample Test with t <sub>m</sub> = 10 s, Partial Discharge < 5 pC  | 2262            |           |      | V <sub>peak</sub> |
| V <sub>IORM</sub>     | Maximum Working Insulation Voltage   | 1414            |           |      | V <sub>peak</sub> |
| V <sub>IOTM</sub>     | Highest Allowable Over Voltage   | 8000            |           |      | V <sub>peak</sub> |
|                       | External Creepage  | 10.0            |           |      | mm                |
|                       | External Clearance   | 10.0            |           |      | mm                |
|                       | Insulation Thickness   | 0.5             |           |      | mm                |
|                       | Safety Limit Values – Maximum Values Allowed in the Event of a Failure   |                 |           |      |                   |
| T <sub>S</sub>        | Case Temperature   | 150             |           |      | °C                |
| I <sub>S,INPUT</sub>  | Input Current  | 200             |           |      | mA                |
| P <sub>S,OUTPUT</sub> | Output Power   | 600             |           |      | mW                |
| R <sub>IO</sub>       | Insulation Resistance at T <sub>S</sub> , V <sub>IO</sub> = 500 V  | 10 <sup>9</sup> |           |      | Ω                 |

## Absolute Maximum Ratings

Stresses exceeding the absolute maximum ratings may damage the device. The device may not function or be operable above the recommended operating conditions and stressing the parts to these levels is not recommended. In addition, extended exposure to stresses above the recommended operating conditions may affect device reliability. The absolute maximum ratings are stress ratings only.  $T_A = 25^\circ\text{C}$  unless otherwise specified.

| Symbol                        | Parameter   | Value                  | Units            |
|-------------------------------|---|------------------------|------------------|
| $T_{STG}$                     | Storage Temperature   | -40 to +125            | $^\circ\text{C}$ |
| $T_{OPR}$                     | Operating Temperature   | -40 to +100            | $^\circ\text{C}$ |
| $T_J$                         | Junction Temperature  | -40 to +125            | $^\circ\text{C}$ |
| $T_{SOL}$                     | Lead Solder Temperature<br>(Refer to Reflow Temperature Profile on page 12) | 260 for 10 seconds     | $^\circ\text{C}$ |
| <b>Input Characteristics</b>  |   |                        |                  |
| $I_F$                         | Average Forward Input Current   | 25                     | mA               |
| $V_R$                         | Reverse Input Voltage   | 5.0                    | V                |
| $PD_I$                        | Input Power Dissipation <sup>(1)</sup>                                      | 45                     | mW               |
| <b>Output Characteristics</b> |   |                        |                  |
| $V_{CC}$                      | Supply Voltage  | 0 to 7.0               | V                |
| $V_O$                         | Output Voltage  | -0.5 to $V_{CC} + 0.5$ | V                |
| $I_O$                         | Average Output Current  | 50                     | mA               |
| $PD_O$                        | Output Power Dissipation <sup>(1)</sup>                                     | 85                     | mW               |

**Note:**

1. No derating required up to  $100^\circ\text{C}$ .

## Recommended Operating Conditions

The Recommended Operating Conditions table defines the conditions for actual device operation. Recommended operating conditions are specified to ensure optimal performance to the datasheet specifications. Fairchild does not recommend exceeding them or designing to absolute maximum ratings.

| Symbol   | Parameter                              | Min. | Max. | Unit             |
|----------|--|------|------|------------------|
| $T_A$    | Ambient Operating Temperature          | -40  | +100 | $^\circ\text{C}$ |
| $V_{CC}$ | Supply Voltages <sup>(2)</sup>         | 3.0  | 5.5  | V                |
| $V_{FL}$ | Logic Low Input Voltage                | 0    | 0.8  | V                |
| $I_{FL}$ | Logic Low Input Current                |      | 250  | $\mu\text{A}$    |
| $I_{FH}$ | Logic High Input Current               | 6.0  | 15   | mA               |
| N        | Fan Out (at $R_L = 1\text{ k}\Omega$ ) |      | 5    | TTL loads        |
| $R_L$    | Output Pull-up Resistor                | 330  | 4000 | $\Omega$         |

**Note:**

2.  $0.1\ \mu\text{F}$  bypass capacitor must be connected between pins 4 and 6.

## Isolation Characteristics

Apply over all recommended conditions, typical value is measured at  $T_A = 25^\circ\text{C}$ .

| Symbol    | Parameter                      | Conditions   | Min.  | Typ.      | Max. | Units                     |
|-----------|--------------------------------|--|-------|-----------|------|---------------------------|
| $V_{ISO}$ | Input-Output Isolation Voltage | $T_A = 25^\circ\text{C}$ , R.H. < 50%, $t = 1.0$ min, $I_{I-O} \leq 20 \mu\text{A}^{(3)(4)}$ | 5,000 |           |      | $\text{VAC}_{\text{RMS}}$ |
| $R_{ISO}$ | Isolation Resistance           | $V_{I-O} = 500 \text{ V}^{(3)}$  |       | $10^{11}$ |      | $\Omega$                  |
| $C_{ISO}$ | Isolation Capacitance          | $V_{I-O} = 0 \text{ V}$ , frequency = $1.0 \text{ MHz}^{(3)}$                                |       | 1.0       |      | pF                        |

### Notes:

- Device is considered a two-terminal device: pins 1 and 3 are shorted together and pins 4, 5, and 6 are shorted together.
- 5,000  $\text{VAC}_{\text{RMS}}$  for 1-minute duration is equivalent to 6,000  $\text{VAC}_{\text{RMS}}$  for 1-second duration.

## Electrical Characteristics

Apply over all recommended conditions;  $T_A = -40^\circ\text{C}$  to  $+100^\circ\text{C}$ ,  $3.0 \text{ V} \leq V_{CC} \leq 5.5 \text{ V}$ ; unless otherwise specified. Typical value is measured at  $T_A = 25^\circ\text{C}$  and  $V_{CC} = 3.3 \text{ V}$  or  $V_{CC} = 5 \text{ V}$ .

| Symbol                        | Parameter                                  | Conditions   | Min. | Typ. | Max. | Units         | Figure |
|-------------------------------|--|--|------|------|------|---------------|--------|
| <b>Input Characteristics</b>  |  |  |      |      |      |               |        |
| $V_F$                         | Forward Voltage                            | $I_F = 10 \text{ mA}$  | 1.05 | 1.45 | 1.80 | V             | 3      |
| $\Delta(V_F / T_A)$           | Temperature Coefficient of Forward Voltage |  |      | -1.8 |      | mV/°C         |        |
| $BV_R$                        | Input Reverse Breakdown Voltage            | $I_R = 10 \mu\text{A}$   | 5.0  |      |      | V             |        |
| $I_{FHL}$                     | Threshold Input Current                    | $V_O = 0.6 \text{ V}$ ,<br>$I_{OL}(\text{sink}) = 13 \text{ mA}$         |      | 2.5  | 6.0  | mA            | 4      |
| <b>Output Characteristics</b> |  |  |      |      |      |               |        |
| $V_{OL}$                      | Logic Low Output Voltage                   | $I_F = \text{rated } I_{FHL}$ ,<br>$I_{OL}(\text{sink}) = 13 \text{ mA}$ |      | 0.4  | 0.6  | V             | 5      |
| $I_{OH}$                      | Logic High Output Current                  | $I_F = 250 \mu\text{A}$ , $V_O = 3.3 \text{ V}$                          |      | 8.0  | 50.0 | $\mu\text{A}$ | 6      |
|                               |  | $I_F = 250 \mu\text{A}$ , $V_O = 5.0 \text{ V}$                          |      | 3.0  | 40.0 | $\mu\text{A}$ | 6      |
| $I_{CCL}$                     | Logic Low Output Supply Current            | $I_F = 10 \text{ mA}$ , $V_{CC} = 3.3 \text{ V}$                         |      | 5.3  | 8.5  | mA            | 7, 9   |
|                               |  | $I_F = 10 \text{ mA}$ , $V_{CC} = 5.0 \text{ V}$                         |      | 7.1  | 10.0 | mA            | 7, 9   |
| $I_{CCH}$                     | Logic High Output Supply Current           | $I_F = 0 \text{ mA}$ , $V_{CC} = 3.3 \text{ V}$                          |      | 3.5  | 7.0  | mA            | 8, 9   |
|                               |  | $I_F = 0 \text{ mA}$ , $V_{CC} = 5.0 \text{ V}$                          |      | 5.3  | 9.0  | mA            | 8, 9   |

## Switching Characteristics

Apply over all recommended conditions;  $T_A = -40^\circ\text{C}$  to  $+100^\circ\text{C}$ ,  $V_{CC} = 3.3\text{ V}$ ,  $I_F = 6.0\text{ mA}$ ; unless otherwise specified. Typical value is measured at  $T_A = 25^\circ\text{C}$  and  $V_{CC} = 3.3\text{ V}$ .

| Symbol    | Parameter                                     | Conditions   | Min. | Typ. | Max. | Units             | Figure     |
|-----------|---|--|------|------|------|-------------------|------------|
| Data Rate |   | $R_L = 350\ \Omega$  |      |      | 10   | Mbit/sec          |            |
| $t_{PHL}$ | Propagation Delay to Logic Low Output         | $R_L = 350\ \Omega$ , $C_L = 15\text{ pF}$                                     |      | 40   | 80   | ns                | 10, 11, 15 |
| $t_{PLH}$ | Propagation Delay to Logic High Output        | $R_L = 350\ \Omega$ , $C_L = 15\text{ pF}$                                     |      | 50   | 90   | ns                | 10, 11, 15 |
| PWD       | Pulse Width Distortion, $ t_{PHL} - t_{PLH} $ | $R_L = 350\ \Omega$ , $C_L = 15\text{ pF}$                                     |      | 10   | 35   | ns                | 12, 13, 15 |
| $t_{PSK}$ | Propagation Delay Skew                        | $R_L = 350\ \Omega$ , $C_L = 15\text{ pF}$ <sup>(5)</sup>                      |      |      | 40   | ns                |            |
| $t_R$     | Output Rise Time (10% to 90%)                 | $R_L = 350\ \Omega$ , $C_L = 15\text{ pF}$                                     |      | 20   |      | ns                | 14, 15     |
| $t_F$     | Output Fall Time (90% to 10%)                 | $R_L = 350\ \Omega$ , $C_L = 15\text{ pF}$                                     |      | 10   |      | ns                | 14, 15     |
| $ CM_H $  | Common-Mode Transient Immunity at Output High | $I_F = 0\text{ mA}$ , $V_O > 2\text{ V}$ , $V_{CM} = 1,000\text{ V}^{(6)}$     | 20   | 40   |      | kV/ $\mu\text{s}$ | 16         |
| $ CM_L $  | Common-Mode Transient Immunity at Output Low  | $I_F = 6.0\text{ mA}$ , $V_O < 0.8\text{ V}$ , $V_{CM} = 1,000\text{ V}^{(6)}$ | 20   | 40   |      | kV/ $\mu\text{s}$ | 16         |

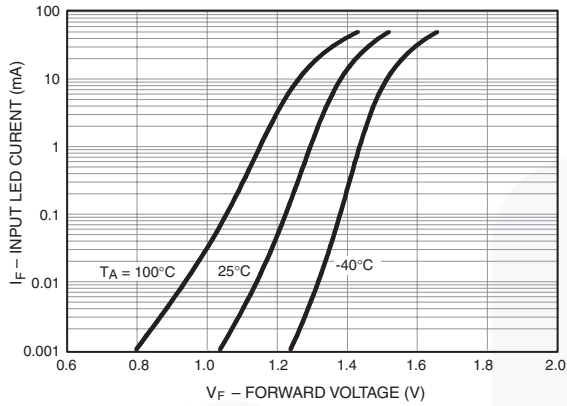
Apply over all recommended conditions;  $T_A = -40^\circ\text{C}$  to  $+100^\circ\text{C}$ ,  $V_{CC} = 5\text{ V}$ ,  $I_F = 6.0\text{ mA}$ ; unless otherwise specified. Typical value is measured at  $T_A = 25^\circ\text{C}$  and  $V_{CC} = 5\text{ V}$ .

| Symbol    | Parameter                                     | Conditions   | Min. | Typ. | Max. | Units             | Figure     |
|-----------|---|--|------|------|------|-------------------|------------|
| Data Rate |   | $R_L = 350\ \Omega$  |      |      | 10   | Mbit/sec          |            |
| $t_{PHL}$ | Propagation Delay to Logic Low Output         | $R_L = 350\ \Omega$ , $C_L = 15\text{ pF}$                                     |      | 37   | 80   | ns                | 10, 11, 15 |
| $t_{PLH}$ | Propagation Delay to Logic High Output        | $R_L = 350\ \Omega$ , $C_L = 15\text{ pF}$                                     |      | 41   | 90   | ns                | 10, 11, 15 |
| PWD       | Pulse Width Distortion, $ t_{PHL} - t_{PLH} $ | $R_L = 350\ \Omega$ , $C_L = 15\text{ pF}$                                     |      | 4    | 25   | ns                | 12, 13, 15 |
| $t_{PSK}$ | Propagation Delay Skew                        | $R_L = 350\ \Omega$ , $C_L = 15\text{ pF}^{(5)}$                               |      |      | 40   | ns                |            |
| $t_R$     | Output Rise Time (10% to 90%)                 | $R_L = 350\ \Omega$ , $C_L = 15\text{ pF}$                                     |      | 22   |      | ns                | 14, 15     |
| $t_F$     | Output Fall Time (90% to 10%)                 | $R_L = 350\ \Omega$ , $C_L = 15\text{ pF}$                                     |      | 9    |      | ns                | 14, 15     |
| $ CM_H $  | Common-Mode Transient Immunity at Output High | $I_F = 0\text{ mA}$ , $V_O > 2\text{ V}$ , $V_{CM} = 1,000\text{ V}^{(6)}$     | 20   | 40   |      | kV/ $\mu\text{s}$ | 16         |
| $ CM_L $  | Common-Mode Transient Immunity at Output Low  | $I_F = 6.0\text{ mA}$ , $V_O < 0.8\text{ V}$ , $V_{CM} = 1,000\text{ V}^{(6)}$ | 20   | 40   |      | kV/ $\mu\text{s}$ | 16         |

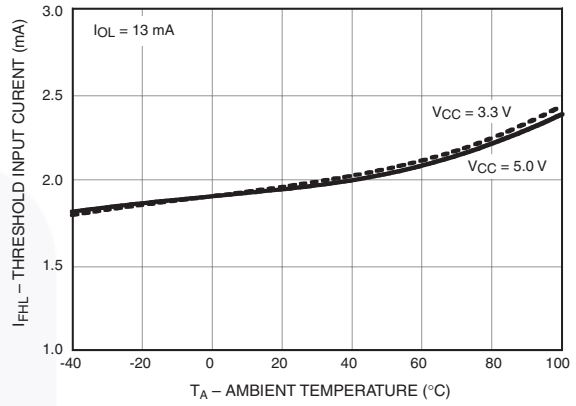
**Notes:**

5.  $t_{PSK}$  is equal to the magnitude of the worst-case difference in  $t_{PHL}$  and/or  $t_{PLH}$  between any two units from the same manufacturing date code that are operated at same case temperature ( $\pm 5^{\circ}\text{C}$ ), at same operating conditions, with equal loads ( $R_L = 350\ \Omega$ ,  $C_L = 15\ \text{pF}$ ), and with an input rise time less than 5 ns.
6. Common-mode transient immunity at output HIGH is the maximum tolerable positive  $dV_{cm}/dt$  on the leading edge of the common-mode impulse signal,  $V_{CM}$ , to assure that the output remains HIGH. Common-mode transient immunity at output LOW is the maximum tolerable negative  $dV_{cm}/dt$  on the trailing edge of the common pulse signal,  $V_{CM}$ , to assure that the output remains LOW.

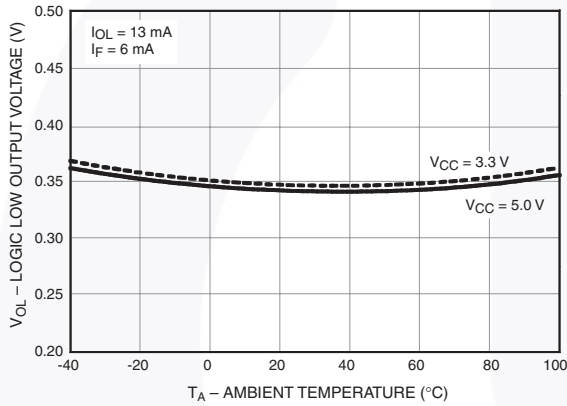
### Typical Performance Characteristics



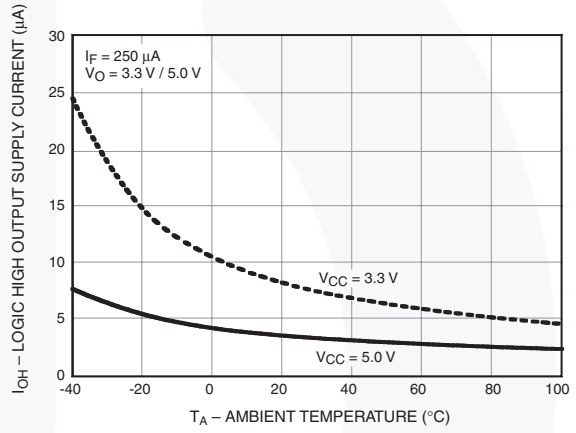
**Figure 3. Input LED Current ( $I_F$ ) vs. Forward Voltage ( $V_F$ )**



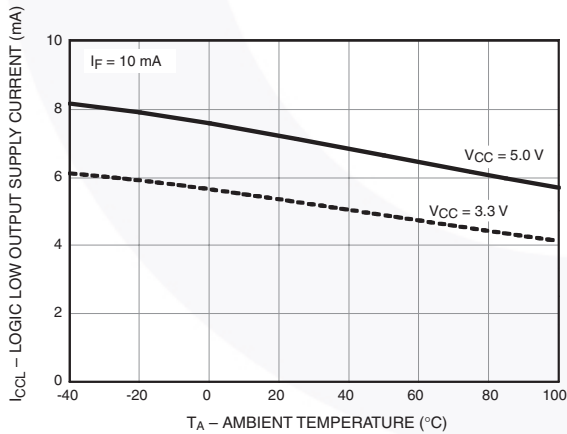
**Figure 4. Threshold Input Current ( $I_{FHL}$ ) vs. Ambient Temperature**



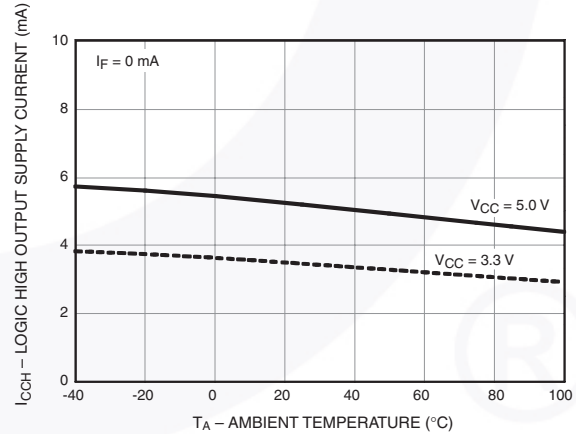
**Figure 5. Logic Low Output Voltage ( $V_{OL}$ ) vs. Ambient Temperature**



**Figure 6. Logic High Output Current ( $I_{OH}$ ) vs. Ambient Temperature**



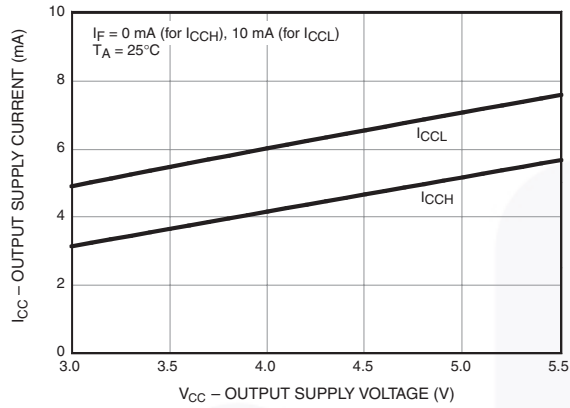
**Figure 7. Logic Low Output Supply Current ( $I_{CCL}$ ) vs. Ambient Temperature**



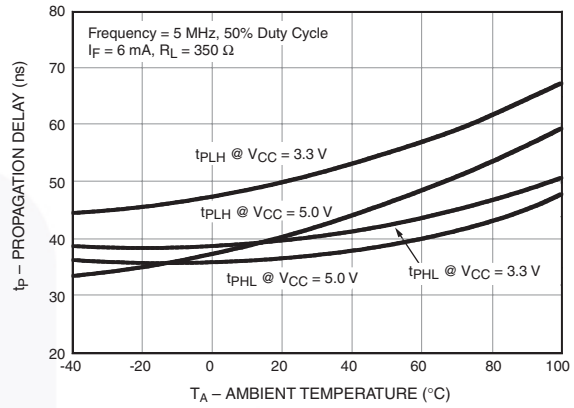
**Figure 8. Logic High Output Supply Current ( $I_{CCH}$ ) vs. Ambient Temperature**



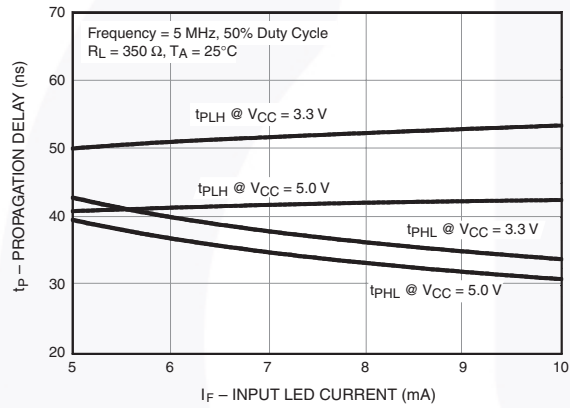
### Typical Performance Characteristics (Continued)



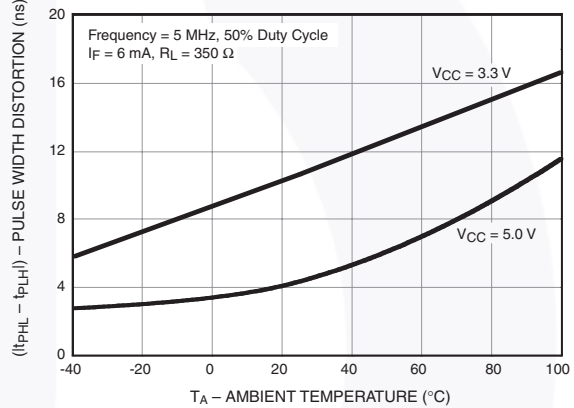
**Figure 9. Output Supply Current ( $I_{CC}$ ) vs. Output Supply Voltage ( $V_{CC}$ )**



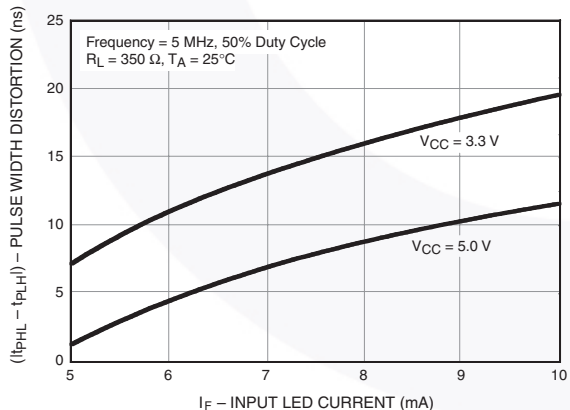
**Figure 10. Propagation Delay vs. Ambient Temperature**



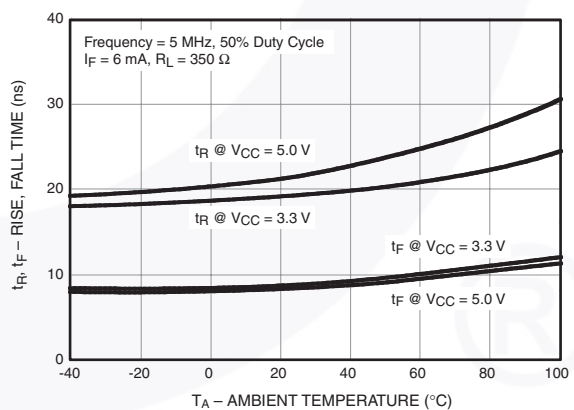
**Figure 11. Propagation Delay vs. Input LED Current ( $I_F$ )**



**Figure 12. Pulse Width Distortion vs. Ambient Temperature**

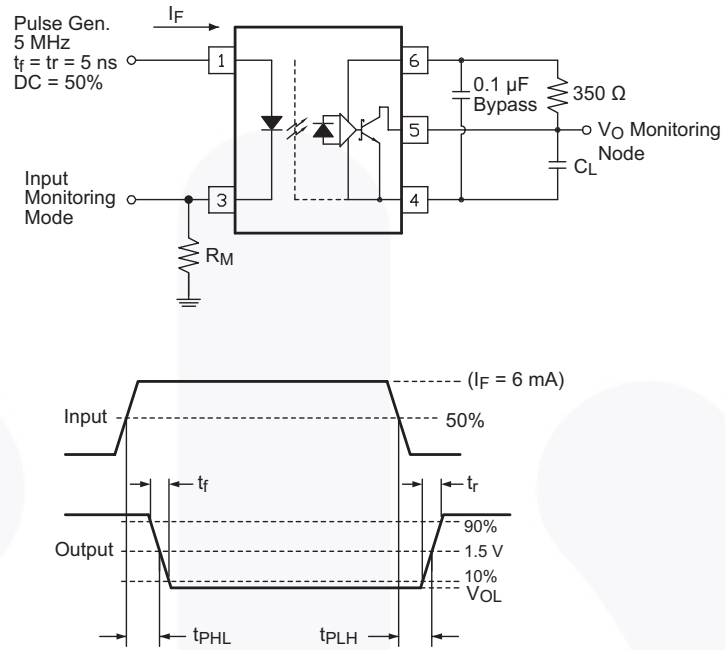


**Figure 13. Pulse Width Distortion vs. Input LED Current ( $I_F$ )**

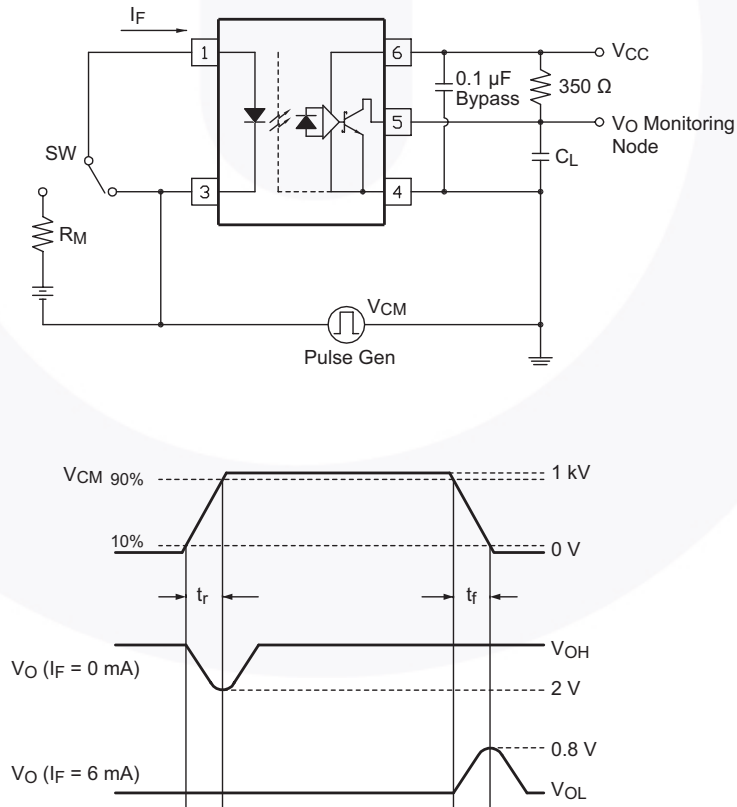


**Figure 14. Rise Time ( $t_R$ ) and Fall Time ( $t_F$ ) vs. Ambient Temperature**

### Test Circuit




**Figure 15. Test Circuit for Propagation Delay, Rise Time, and Fall Time**



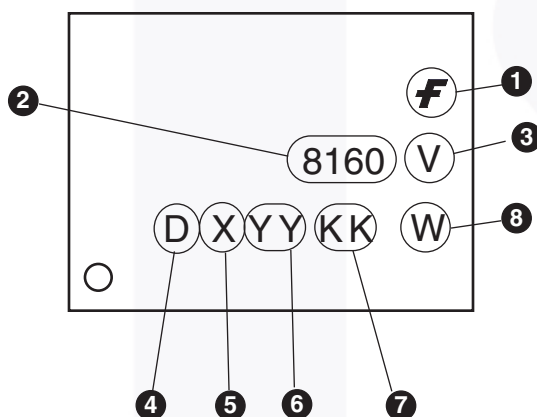
**Figure 16. Test Circuit for Instantaneous Common-Mode Rejection Voltage**

## Ordering Information

| Part Number | Package  | Packing Method                       |
|-------------|--|--------------------------------------|
| FOD8160     | Wide Body SOP 5-Pin                              | Tube (100 units per tube)            |
| FOD8160R2   | Wide Body SOP 5-Pin                              | Tape and Reel (1,000 units per reel) |
| FOD8160V    | Wide Body SOP 5-Pin, DIN EN/IEC60747-5-5 Option  | Tube (100 units per tube)            |
| FOD8160R2V  | Wide Body SOP 5-Pin, DIN EN/ IEC60747-5-5 Option | Tape and Reel (1,000 units per reel) |

 All packages are lead free per JEDEC: J-STD-020B standard.

## Marking Information



### Definitions

|   |   |
|---|---|
| 1 | Fairchild logo  |
| 2 | Device number, e.g., '8160' for FOD8160   |
| 3 | DIN EN/IEC60747-5-5 option (only appears on component ordered with this option) |
| 4 | Plant code, e.g., 'D'   |
| 5 | Last-digit year code, e.g., 'E' for 2014  |
| 6 | Two-digit work week ranging from '01' to '53'                                   |
| 7 | Lot-traceability code   |
| 8 | Package assembly code, W  |

## Reflow Profile

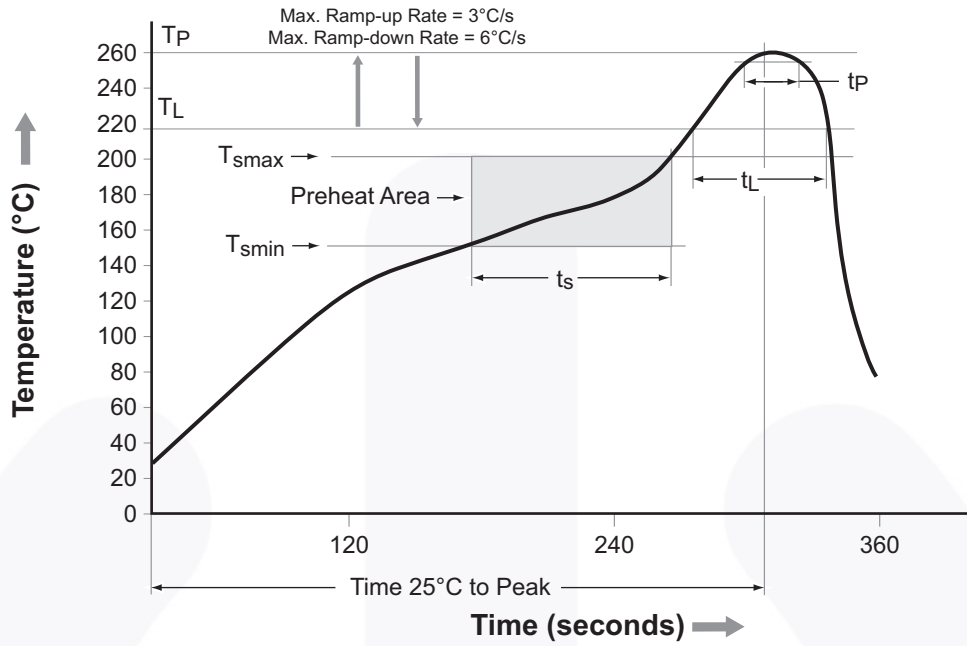
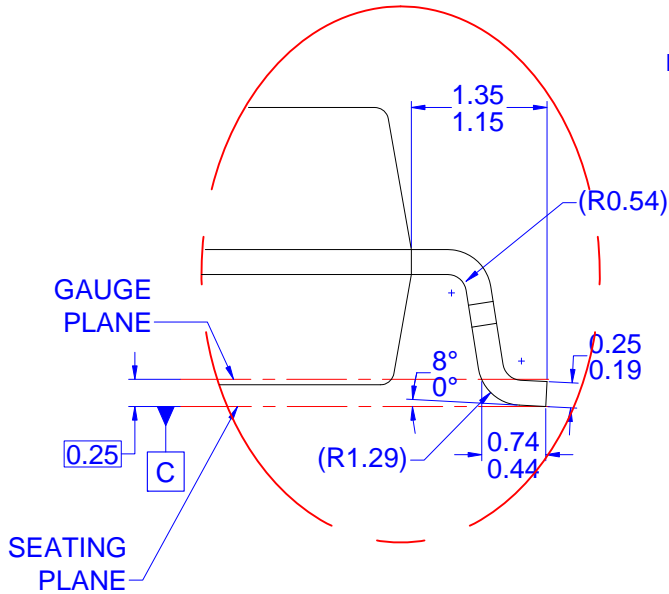
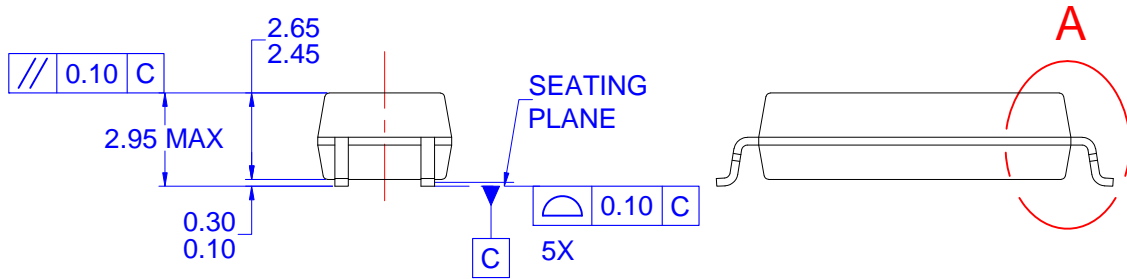
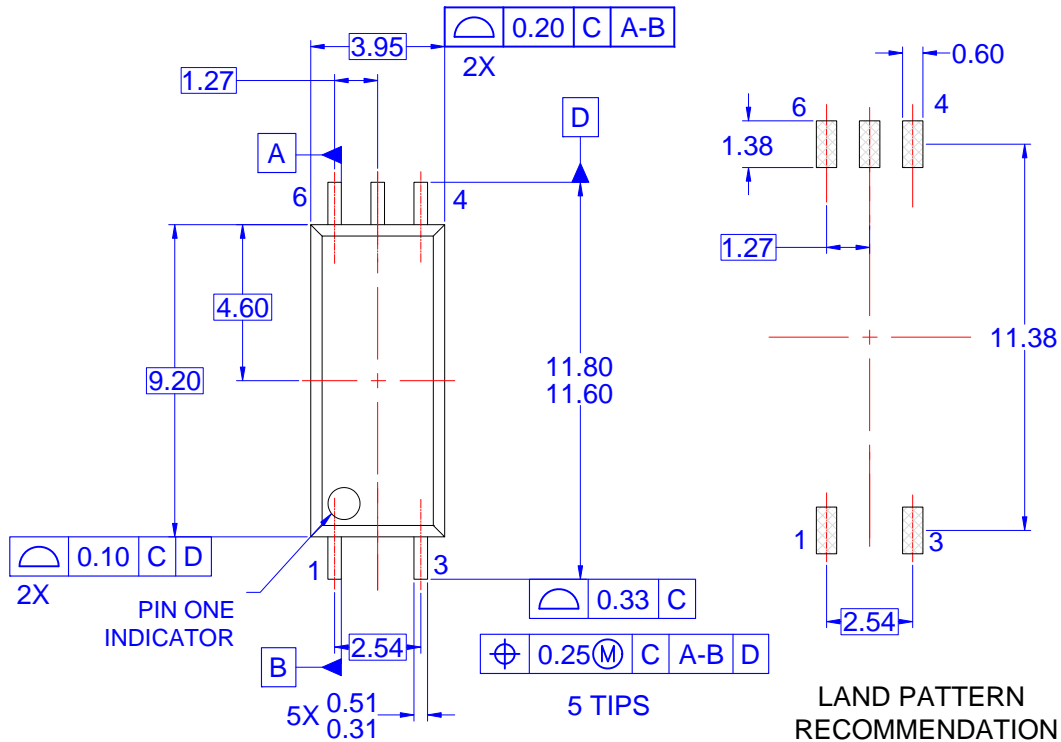


Figure 17. Reflow Profile

| Profile Feature                                  | Pb-Free Assembly Profile |
|--|--------------------------|
| Temperature Minimum ( $T_{smin}$ )               | 150°C                    |
| Temperature Maximum ( $T_{smax}$ )               | 200°C                    |
| Time ( $t_s$ ) from ( $T_{smin}$ to $T_{smax}$ ) | 60 to 120 seconds        |
| Ramp-Up Rate ( $t_L$ to $t_P$ )                  | 3°C/second maximum       |
| Liquidous Temperature ( $T_L$ )                  | 217°C                    |
| Time ( $t_L$ ) Maintained Above ( $T_L$ )        | 60 to 150 seconds        |
| Peak Body Package Temperature                    | 260°C +0°C / -5°C        |
| Time ( $t_P$ ) within 5°C of 260°C               | 30 seconds               |
| Ramp-Down Rate ( $T_P$ to $T_L$ )                | 6°C/second maximum       |
| Time 25°C to Peak Temperature                    | 8 minutes maximum        |



**DETAIL A**  
SCALE: 3.2:1






NOTES: UNLESS OTHERWISE SPECIFIED

- A) THIS PACKAGE DOES NOT CONFORM TO ANY STANDARD.
- B) ALL DIMENSIONS ARE IN MILLIMETERS.
- C) DIMENSIONS ARE EXCLUSIVE OF BURRS, MOLD FLASH AND TIE BAR PROTRUSIONS
- D) DRAWING CONFORMS TO ASME Y14.5M-1994
- E) DRAWING FILE NAME: MKT-M05AREV3



## TRADEMARKS

The following includes registered and unregistered trademarks and service marks, owned by Fairchild Semiconductor and/or its global subsidiaries, and is not intended to be an exhaustive list of all such trademarks.

|   |  |   |   |
|---|--|---|---|
| AccuPower™  | F-PFS™   | OPTOPLANAR®   |  |
| AttitudeEngine™   | FRFET®   |  | TinyBoost®  |
| Awinda®   | Global Power Resource <sup>SM</sup>            | Power Supply WebDesigner™   | TinyBuck®   |
| AX-CAP®*  | GreenBridge™                                   | PowerTrench®  | TinyCalc™   |
| BitSiC™   | Green FPS™                                     | PowerXS™  | TinyLogic®  |
| Build it Now™   | Green FPS™ e-Series™                           | Programmable Active Droop™  | TINYOPTO™   |
| CorePLUS™   | Gmax™  | QFET®   | TinyPower™  |
| CorePOWER™  | GTO™   | QS™   | TinyPWM™  |
| CROSSVOL™   | IntelliMAX™                                    | Quiet Series™   | TinyWire™   |
| CTL™  | ISOPLANAR™                                     | RapidConfigure™   | TranSiC™  |
| Current Transfer Logic™   | Making Small Speakers Sound Louder and Better™ |  | TriFault Detect™  |
| DEUXPEED®   | MegaBuck™                                      | Saving our world, 1mW/W/kW at a time™   | TRUECURRENT®*   |
| Dual Cool™  | MICROCOUPLER™                                  | SignalWise™   | μSerDes™  |
| EcoSPARK®   | MicroFET™                                      | SmartMax™   |  |
| EfficientMax™   | MicroPak™                                      | SMART START™  | UHC®  |
| ESBC™   | MicroPak2™                                     | Solutions for Your Success™   | Ultra FRFET™  |
|  | MillerDrive™                                   | SPM®  | UniFET™   |
| Fairchild®  | MotionMax™                                     | STEALTH™  | VCX™  |
| Fairchild Semiconductor®  | MotionGrid®                                    | SuperFET®   | VisualMax™  |
| FACT Quiet Series™  | MTi®   | SuperSOT™-3   | VoltagePlus™  |
| FACT®   | MTx®   | SuperSOT™-6   | XS™   |
| FastvCore™  | MVN®   | SuperSOT™-8   | Xsens™  |
| FETBench™   | mWSaver®                                       | SupreMOS®   | 仙童®   |
| FPS™  | OptoHiT™                                       | SyncFET™  |   |
|   | OPTOLOGIC®                                     | Sync-Lock™  |   |

\* Trademarks of System General Corporation, used under license by Fairchild Semiconductor.

## DISCLAIMER

FAIRCHILD SEMICONDUCTOR RESERVES THE RIGHT TO MAKE CHANGES WITHOUT FURTHER NOTICE TO ANY PRODUCTS HEREIN TO IMPROVE RELIABILITY, FUNCTION, OR DESIGN. TO OBTAIN THE LATEST, MOST UP-TO-DATE DATASHEET AND PRODUCT INFORMATION, VISIT OUR WEBSITE AT [HTTP://WWW.FAIRCHILDSEMI.COM](http://www.fairchildsemi.com). FAIRCHILD DOES NOT ASSUME ANY LIABILITY ARISING OUT OF THE APPLICATION OR USE OF ANY PRODUCT OR CIRCUIT DESCRIBED HEREIN; NEITHER DOES IT CONVEY ANY LICENSE UNDER ITS PATENT RIGHTS, NOR THE RIGHTS OF OTHERS. THESE SPECIFICATIONS DO NOT EXPAND THE TERMS OF FAIRCHILD'S WORLDWIDE TERMS AND CONDITIONS, SPECIFICALLY THE WARRANTY THEREIN, WHICH COVERS THESE PRODUCTS.

## AUTHORIZED USE

Unless otherwise specified in this data sheet, this product is a standard commercial product and is not intended for use in applications that require extraordinary levels of quality and reliability. This product may not be used in the following applications, unless specifically approved in writing by a Fairchild officer: (1) automotive or other transportation, (2) military/aerospace, (3) any safety critical application – including life critical medical equipment – where the failure of the Fairchild product reasonably would be expected to result in personal injury, death or property damage. Customer's use of this product is subject to agreement of this Authorized Use policy. In the event of an unauthorized use of Fairchild's product, Fairchild accepts no liability in the event of product failure. In other respects, this product shall be subject to Fairchild's Worldwide Terms and Conditions of Sale, unless a separate agreement has been signed by both Parties.

## ANTI-COUNTERFEITING POLICY

Fairchild Semiconductor Corporation's Anti-Counterfeiting Policy. Fairchild's Anti-Counterfeiting Policy is also stated on our external website, [www.fairchildsemi.com](http://www.fairchildsemi.com), under Terms of Use

Counterfeiting of semiconductor parts is a growing problem in the industry. All manufacturers of semiconductor products are experiencing counterfeiting of their parts. Customers who inadvertently purchase counterfeit parts experience many problems such as loss of brand reputation, substandard performance, failed applications, and increased cost of production and manufacturing delays. Fairchild is taking strong measures to protect ourselves and our customers from the proliferation of counterfeit parts. Fairchild strongly encourages customers to purchase Fairchild parts either directly from Fairchild or from Authorized Fairchild Distributors who are listed by country on our web page cited above. Products customers buy either from Fairchild directly or from Authorized Fairchild Distributors are genuine parts, have full traceability, meet Fairchild's quality standards for handling and storage and provide access to Fairchild's full range of up-to-date technical and product information. Fairchild and our Authorized Distributors will stand behind all warranties and will appropriately address any warranty issues that may arise. Fairchild will not provide any warranty coverage or other assistance for parts bought from Unauthorized Sources. Fairchild is committed to combat this global problem and encourage our customers to do their part in stopping this practice by buying direct or from authorized distributors.

## PRODUCT STATUS DEFINITIONS

### Definition of Terms

| Datasheet Identification | Product Status        | Definition  |
|--------------------------|-----------------------|---|
| Advance Information      | Formative / In Design | Datasheet contains the design specifications for product development. Specifications may change in any manner without notice.   |
| Preliminary              | First Production      | Datasheet contains preliminary data; supplementary data will be published at a later date. Fairchild Semiconductor reserves the right to make changes at any time without notice to improve design. |
| No Identification Needed | Full Production       | Datasheet contains final specifications. Fairchild Semiconductor reserves the right to make changes at any time without notice to improve the design.   |
| Obsolete                 | Not In Production     | Datasheet contains specifications on a product that is discontinued by Fairchild Semiconductor. The datasheet is for reference information only.  |

Rev. I77

# Mouser Electronics

Authorized Distributor

Click to View Pricing, Inventory, Delivery & Lifecycle Information:

[ON Semiconductor:](#)

[FOD816](#)