

# Digital Timer H5CX

Please read and understand this catalog before purchasing the products. Please consult your OMRON representative if you have any questions or comments. Refer to *Warranty and Application Considerations* (page 52), and *Safety Precautions* (page 47).

## DIN 48 × 48-mm Multifunction Digital Timer/2-stage Digital Timer

- Highly visible display with backlit negative transmissive LCD.
- Finger-safe terminals (screw terminal block models).
- Complies with IP66, NEMA4, and UL Type 4X (when using the Y92S-29 Waterproof Packing and Y92F-30 Flush Mounting Adapter).

### H5CX Series



**H5CX-A/L**  
**Multifunction Digital Timer with 4-digit display**  
H5CX-A (standard type)  
H5CX-L (economy type)



**H5CX-B**  
**2-stage Digital Timer with 6-digit display**  
H5CX-B

### Contents

#### Multifunction Digital Timer

H5CX-A/L..... 2

#### 2-stage Digital Timer

H5CX-B..... 35

#### Common to All Models

Safety Precautions..... 47

Warranty and Application Considerations ..... 52

## Multifunction Digital Timer H5CX-A/-L

### DIN 48 × 48-mm Multifunction Digital Timer with a Bright, Easy-to-view, Negative Transmissive LCD.

- Programmable PV color to visually alert when output status changes (screw terminal block models).
- Intuitive setting enabled using DIP switch (H5CX-A/-A11 models) and ergonomic up/down digit keys.
- Twin timer in one body to meet a broader range of cyclic control application requirements as well as ON/OFF duty adjustable flicker mode.
- PNP/NPN switchable DC-voltage input (H5CX-A/-A11 models).
- Meet a variety of mounting requirements: Screw terminal block models, and pin-style terminal models.
- Six-language instruction manual.



### Contents

Model Number Structure .....	3
Ordering Information .....	3
Specifications .....	4
Connections .....	7
Nomenclature .....	11
Dimensions .....	12
Operating Procedures .....	17
Setting Procedure Guide .....	17
Operating Procedures (Timer Function) .....	18
Operating Procedures (Twin Timer Function) .....	26
Operation in Timer/Twin Timer Selection Mode .....	31
Additional Information .....	32

# Model Number Structure

## Model Number Legend

H5CX-□□□□-□  
1 2 3 4 5

**1. Type classifier**

- A: Standard type
- L: Economy type

**2. External connection**

- None: Screw terminals
- 8: 8-pin socket
- 11: 11-pin socket

**3. Output type**

- None: Contact output
- S: Transistor output

**4. Supply voltage**

- None: 100 to 240 VAC 50/60 Hz
- D: 12 to 24 VDC/24 VAC 50/60 Hz

**5. Case color**

- None: Black
- G: Light gray (Munsell 5Y7/1): Produced upon request.

## Ordering Information

### List of Models

Output type	Supply voltage	Models		
		Standard type		Economy type
		Screw terminals	11-pin socket	8-pin socket
Contact output	100 to 240 VAC	H5CX-A	H5CX-A11	H5CX-L8
	12 to 24 VDC/24 VAC	H5CX-AD	H5CX-A11D	H5CX-L8D
Transistor output	100 to 240 VAC	H5CX-AS	H5CX-A11S	H5CX-L8S
	12 to 24 VDC/24 VAC	H5CX-ASD	H5CX-A11SD	H5CX-L8SD

**Note:** Depending on the wiring, unwanted current from the AC power supply may occasionally burn out internal parts. H5CX-A/-L (except for H5CX-A11/-A11S) models do not have a transformer. Therefore, the power supply and input circuit are not insulated. Refer to *Safety Precautions (H5CX-A/-L)* on page 49 for wiring details. The power supply and input circuit for H5CX-A11/-A11S models have basic insulation.

### Accessories (Order Separately)

Name	Models	
Flush Mounting Adapter (See note 1.)	Y92F-30	
Waterproof Packing (See note 1.)	Y92S-29	
Track Mounting/ Front Connecting Socket	8-pin	P2CF-08
	8-pin, finger-safe type	P2CF-08-E
	11-pin	P2CF-11
	11-pin, finger-safe type	P2CF-11-E
Back Connecting Socket	8-pin	P3G-08
	8-pin, finger-safe type	P3G-08 with Y92A-48G (See note 2.)
	11-pin	P3GA-11
	11-pin, finger-safe type	P3GA-11 with Y92A-48G (See note 2.)
Hard Cover	Y92A-48	
Soft Cover	Y92A-48F1	
Mounting Track	50 cm (l) × 7.3 mm (t)	PFP-50N
	1 m (l) × 7.3 mm (t)	PFP-100N
	1 m (l) × 16 mm (t)	PFP-100N2
End Plate	PFP-M	
Spacer	PFP-S	

- Note 1.** Supplied with H5CX-A□ models (except for H5CX-A11□ and H5CX-L8□ models).
- 2.** Y92A-48G is a finger-safe terminal cover attached to the P3G-08 or P3GA-11 Socket.

# Specifications

## ■ Ratings

Item	H5CX-A□	H5CX-A11□	H5CX-L8□
Classification	Digital timer		
Rated supply voltage	100 to 240 VAC (50/60 Hz), 24 VAC (50/60 Hz)/12 to 24 VDC (permissible ripple: 20% (p-p) max.)		
Operating voltage range	85% to 110% rated supply voltage (12 to 24 VDC: 90% to 110%)		
Power consumption (See note 1.)	Approx. 6.2 VA at 264 VAC Approx. 5.1 VA at 26.4 VAC Approx. 2.4 W at 12 VDC		
Mounting method	Flush mounting	Flush mounting, surface mounting, DIN track mounting	
External connections	Screw terminals	11-pin socket	8-pin socket
Terminal screw tightening torque	0.5 N·m max.	---	
Display (See note 2.)	7-segment, negative transmissive LCD; Present value: 11.5-mm-high characters, red or green (programmable) Set value: 6-mm-high characters, green	7-segment, negative transmissive LCD Present value: 11.5-mm-high characters, red Set value: 6-mm-high characters, green	
Digits	4 digits		
Time ranges	9.999 s (0.001-s unit), 99.99 s (0.01-s unit), 999.9 s (0.1-s unit), 9999 s (1-s unit), 99 min 59 s (1-s unit) 999.9 min (0.1-min unit), 9999 min (1-min unit), 99 h 59 min (1-min unit), 999.9 h (0.1-h unit), 9999 h (1-h unit)		
Timer mode	Elapsed time (Up), remaining time (Down) (selectable)		
Input signals	Signal, reset, gate		Signal, reset
Input method	No-voltage input/voltage input (switchable) <u>No-voltage Input</u> ON impedance: 1 kΩ max. (Leakage current: 5 to 20 mA when 0 Ω) ON residual voltage: 3 V max. OFF impedance: 100 kΩ min. <u>Voltage Input</u> High (logic) level: 4.5 to 30 VDC Low (logic) level: 0 to 2 VDC (Input resistance: approx. 4.7 kΩ)		<u>No-voltage Input</u> ON impedance: 1 kΩ max. (Leakage current: 5 to 20 mA when 0 Ω) ON residual voltage: 3 V max. OFF impedance: 100 kΩ min.
Signal, reset, gate	Minimum input signal width: 1 or 20 ms (selectable, same for all input)		
Reset system	Power resets (except for A-3, b-1, and F modes), external and manual reset		
Power reset	Minimum power-opening time: 0.5 s (except for A-3, b-1, and F mode)		
Reset voltage	10% max. of rated supply voltage		
Sensor waiting time	250 ms max. (Control output is turned OFF and no input is accepted during sensor waiting time.)		
Output modes	A, A-1, A-2, A-3, b, b-1, d, E, F, Z, ton or toff		
One-shot output time	0.01 to 99.99 s		
Control output	SPDT contact output: 5 A at 250 VAC/30 VDC, resistive load (cosφ=1) Minimum applied load: 10 mA at 5 VDC (failure level: P, reference value) Transistor output: NPN open collector, 100 mA at 30 VDC max. residual voltage: 1.5 VDC max. (Approx. 1 V) Leakage current: 0.1 mA max. Output category according to EN60947-5-1 for Timers with Contact Outputs (AC-15; 250 V 3 A/AC-13; 250 V 5 A/DC-13; 30 V 0.5 A) Output category according to EN60947-5-2 for Timers with Transistor Outputs (DC-13; 30 V 100 mA) NEMA B300 Pilot Duty, 1/4 HP 5-A resistive load at 120 VAC, 1/3 HP 5-A resistive load at 240 VAC		
Key protection	Yes		
Memory backup	EEPROM (overwrites: 100,000 times min.) that can store data for 10 years min.		
Ambient temperature	Operating: -10 to 55°C (-10 to 50°C if timers are mounted side by side) (with no icing or condensation) Storage: -25 to 65°C (with no icing or condensation)		
Ambient humidity	25% to 85%		
Case color	Black (N1.5)		
Attachments	Waterproof packing, flush mounting adapter, label for DIP switch settings	Label for DIP switch settings	None

**Note 1.** Inrush current will flow for a short time when the power supply is turned ON. Refer to *Inrush Current (Reference Values)* on page 6.

**2.** The display is lit only when the power is ON.

## ■ Characteristics

Item	H5CX-A□/-A11□/-L8□
Accuracy of operating time and setting error (including temperature and voltage influences) (See note 1.)	Power-ON start: $\pm 0.01\% \pm 50$ ms max. Rated against set value Signal start: $\pm 0.005\% \pm 30$ ms max. Rated against set value Signal start for transistor output model: $\pm 0.005\% \pm 3$ ms max. (See note 2.) If the set value is within the sensor waiting time at startup the control output of the H5CX will not turn ON until the sensor waiting time passes.
Insulation resistance	100 M $\Omega$ min. (at 500 VDC) between current-carrying terminal and exposed non-current-carrying metal parts, and between non-continuous contacts
Dielectric strength	2,000 VAC, 50/60 Hz for 1 min between current-carrying metal parts and non-current-carrying metal parts 1,000 VAC (for H5CX-□SD), 50/60 Hz for 1 min between control output, power supply, and input circuit (2,000 VAC for models other than H5CX-□SD) 1,000 VAC, 50/60 Hz for 1 min between non-continuous contacts
Impulse withstand voltage	3 kV (between power terminals) for 100 to 240 VAC, 1 kV for 24 VAC/12 to 24 VDC 4.5 kV (between current-carrying terminal and exposed non-current-carrying metal parts) for 100 to 240 VAC 1.5 kV for 24 VAC/12 to 24 VDC
Noise immunity	$\pm 1.5$ kV (between power terminals) and $\pm 600$ V (between input terminals), square-wave noise by noise simulator (pulse width: 100 ns/1 $\mu$ s, 1-ns rise)
Static immunity	Destruction: 15 kV Malfunction: 8 kV
Vibration resistance	Destruction: 10 to 55 Hz with 0.75-mm single amplitude each in three directions, four cycles each (8 min per cycle) Malfunction: 10 to 55 Hz with 0.35-mm single amplitude each in three directions, four cycles each (8 min per cycle)
Shock resistance	Destruction: 294 m/s <sup>2</sup> each in three directions Malfunction: 98 m/s <sup>2</sup> each in three directions
Life expectancy	Mechanical: 10,000,000 operations min. (under no load at 18,000 operations/h) Electrical: 100,000 operations min. (5 A at 250 VAC, resistive load at 1,800 operations/h) See <i>Life-test Curve</i> on page 6.
Approved safety standards (See notes 3 and 4.)	UL508/Listing, UL50 Type 4X for indoor use (enclosure rating), CSA C22.2 No. 14, conforms to EN61812-1 (Pollution degree 2/overvoltage category III) Conforms to VDE0106/P100 (finger protection).
EMC	(EMI) EN61812-1 Emission Enclosure: EN55011 Group 1 class A Emission AC mains: EN55011 Group 1 class A (EMS) EN61812-1 Immunity ESD: EN61000-4-2: 6 kV contact discharge (level 2) 8 kV air discharge (level 3) Immunity RF-interference: EN61000-4-3: 10 V/m (Amplitude-modulated, 80 MHz to 1 GHz) (level 3); 10 V/m (Pulse-modulated, 900 MHz $\pm 5$ MHz) (level 3) Immunity Conducted Disturbance: EN61000-4-6: 10 V (0.15 to 80 MHz) (level 3) Immunity Burst: EN61000-4-4: 2 kV power-line (level 3); 1 kV I/O signal-line (level 4) Immunity Surge: EN61000-4-5: 1 kV line to lines (power and output lines) (level 3); 2 kV line to ground (power and output lines) (level 3) Immunity Voltage Dip/Interruption EN61000-4-11: 0.5 cycle, 100% (rated voltage)
Degree of protection	Panel surface: IP66 and NEMA4 (indoors), and UL Type 4X (indoors) (See note 4.)
Weight	H5CX-A□: Approx. 135 g, H5CX-A11□/-L8□: Approx. 105 g

**Note 1.** The values are based on the set value.

**2.** The value is applied for a minimum pulse width of 1 ms.

**3.** To meet UL listing requirements with H5CX-L8□/-A11□ models, an OMRON P2CF-08-□ or P3G-08 Socket must be mounted on the Timer. Otherwise, H5CX-L8□/-A11□ models are considered to meet UL508 recognition requirements.

**4.** The Y92S-29 Waterproof Packing and Y92F-30 Flush Mounting Adapter are necessary to ensure IP66, NEMA4, and UL Type 4X water-proofing between the H5CX and installation panel.

## ■ Life-test Curve (Reference Values)

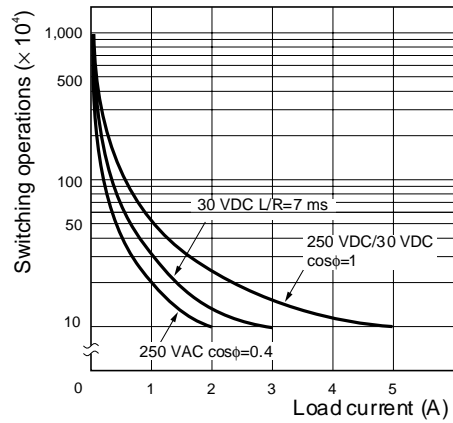

Reference: A maximum current of 0.15 A can be switched at 125 VDC ( $\cos\phi=1$ ) and a maximum current of 0.1 A can be switched if L/R is 7 ms. In both cases, a life of 100,000 operations can be expected. The minimum applicable load is 10 mA at 5 VDC (failure level: P).

## ■ Inrush Current (Reference Values)

Voltage	Applied voltage	Inrush current (peak value)	Time
100 to 240 VAC	264 VAC	5.3 A	0.4 ms
24 VAC/ 12 to 24 VDC	26.4 VAC	6.4 A	1.4 ms
	26.4 VDC	4.4 A	1.7 ms

# Connections

## ■ Block Diagram

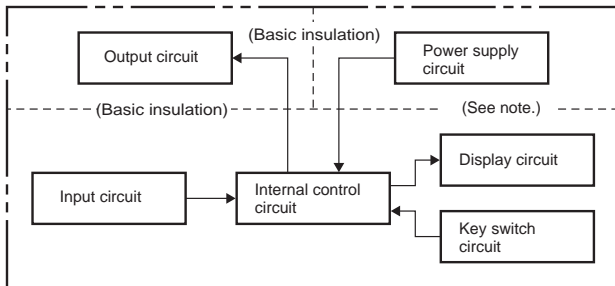

**Note:** Power circuit is not insulated from the input circuit, except for H5CX-A11/-A11S, which have basic insulation.

## ■ I/O Functions

<b>Inputs</b>	<b>Start signal</b>	Stops timing in A-2 and A-3 (power ON delay) modes. Starts timing in other modes.
	<b>Reset</b>	Resets present value. (In elapsed time mode, the present value returns to 0; in remaining time mode, the present value returns to the set value.) Count inputs are not accepted and control output turns OFF while reset input is ON. Reset indicator is lit while reset input is ON.
	<b>Gate</b>	Inhibits timer operation.
<b>Outputs</b>	<b>Control output (OUT)</b>	Outputs take place according to designated operating mode when timer reaches corresponding set value.

## Terminal Arrangement

Confirm that the power supply meets specifications before use.

### H5CX-A/-AD

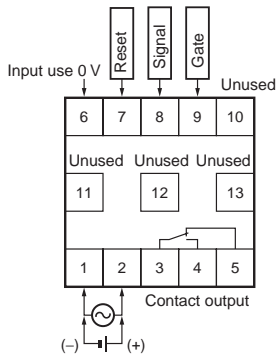

The power supply and input circuit are not insulated. (See note 2.)  
Terminals 1 and 6 of the H5CX-AD are connected internally.

### H5CX-AS/-ASD

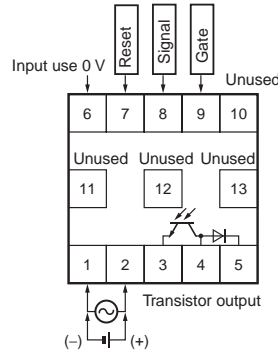

The power supply and input circuit are not insulated. (See note 2.)  
Terminals 1 and 6 of the H5CX-ASD are connected internally.

### H5CX-A11/-A11D

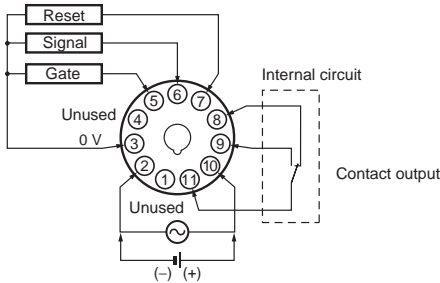

The power supply and input circuit of the H5CX-A11 have basic insulation.  
The power supply and input circuit of the H5CX-A11D are not insulated. (See note 2.)  
Terminals 2 and 3 of the H5CX-A11D are connected internally.

### H5CX-A11S/-A11SD

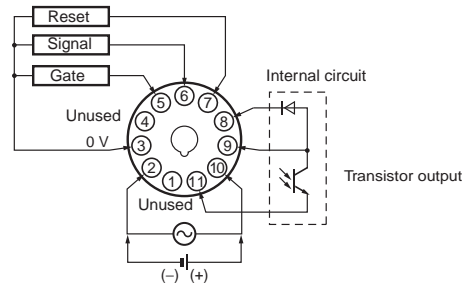

The power supply and input circuit of the H5CX-A11S have basic insulation.  
The power supply and input circuit of the H5CX-A11SD are not insulated. (See note 2.)  
Terminals 2 and 3 of the H5CX-A11SD are connected internally.

### H5CX-L8/-L8D

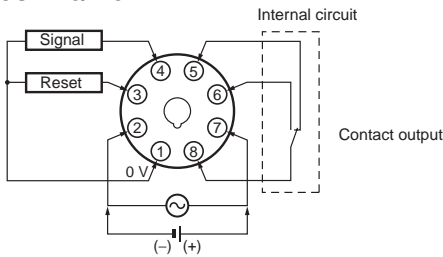

The power supply and input circuit are not insulated. (See note 2.)  
Terminals 1 and 2 of the H5CX-L8D are connected internally.

### H5CX-L8S/-L8SD

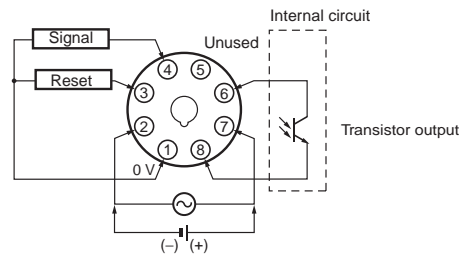

The power supply and input circuit are not insulated. (See note 2.)  
Terminals 1 and 2 of the H5CX-L8SD are connected internally.

**Note 1.** Do not connect unused terminals as relay terminals.

**2.** The power supply and input circuit are not insulated, so unwanted current from the AC power supply may burn out internal parts. Refer to *Safety Precautions (H5CX-A/-L)* on page 49 for wiring details.



## Input Circuits

### Signal, Reset, and Gate Input

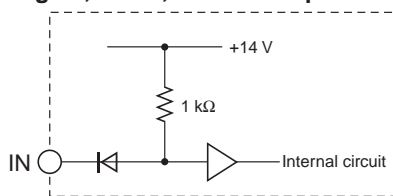

**Note:** When using no-voltage input (NPN input).

## Input Connections

The inputs of the H5CX-A□/-A11□ are no-voltage (short-circuit or open) inputs or voltage inputs.

The input of the H5CX-L8□ is no-voltage input only.

**Note:** Power circuit is not insulated from the input circuit, except for H5CX-A11/-A11S, which have basic insulation. For wiring, refer to *Safety Precautions (H5CX-A/-L)* on page 49.

## No-voltage Inputs (NPN Inputs)

### Open Collector

(Connection to NPN open collector output sensor)

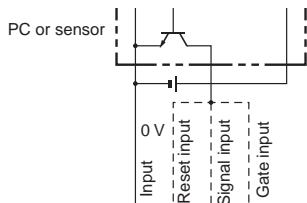

H5CX-A□	⑥	⑦	⑧	⑨
H5CX-A11□	③	⑦	⑥	⑤
H5CX-L8□	①	③	④	—

Operate with transistor ON

### Voltage Output

(Connection to a voltage output sensor)

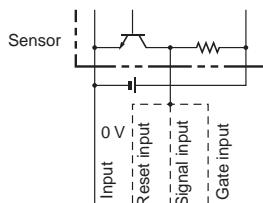

H5CX-A□	⑥	⑦	⑧	⑨
H5CX-A11□	③	⑦	⑥	⑤
H5CX-L8□	①	③	④	—

Operate with transistor ON

### Contact Input

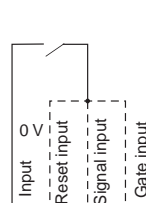

H5CX-A□	⑥	⑦	⑧	⑨
H5CX-A11□	③	⑦	⑥	⑤
H5CX-L8□	①	③	④	—

Operate with relay ON

### DC Two-wire Sensor

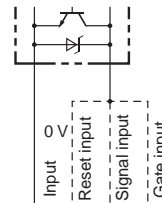

H5CX-A□	⑥	⑦	⑧	⑨
H5CX-A11□	③	⑦	⑥	⑤
H5CX-L8□	①	③	④	—

Operate with transistor ON

## No-voltage Input Signal Levels

No-contact input	Short-circuit level Transistor ON Residual voltage: 3 V max. Impedance when ON: 1 kΩ max. (the leakage current is 5 to 20 mA when the impedance is 0 Ω)
	Open level Transistor OFF Impedance when OFF: 100 kΩ min.
Contact input	Use contact which can adequately switch 5 mA at 10 V

**Note:** The DC voltage must be 30 VDC max.

## Applicable Two-wire Sensor

Leakage current: 1.5 mA max.  
Switching capacity: 5 mA min.  
Residual voltage: 3.0 VDC max.  
Operating voltage: 10 VDC

## Voltage Inputs (PNP Inputs)

### No-contact Input (NPN Transistor)

(Connection to NPN open collector output sensor)

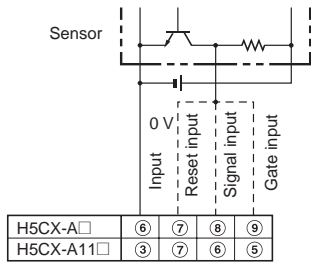

Operate with transistor OFF

### No-contact Input (PNP Transistor)

(Connection to PNP open collector output sensor)

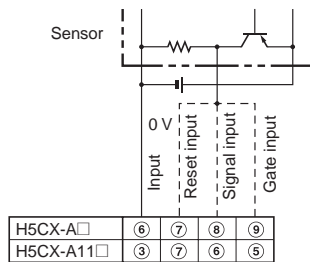

Operate with transistor ON

### Contact Input

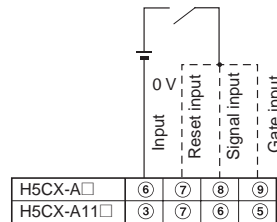

Operate with relay ON

### Voltage Input Signal Levels

High level (Input ON): 4.5 to 30 VDC  
 Low level (Input OFF): 0 to 2 VDC  
 Input resistance: Approx. 4.7 kΩ

**Note:** The DC voltage must be 30 VDC max.

# Nomenclature

## Indicator

- ① Reset Indicator (orange)
- ② Key Protection Indicator (orange)
- ③ Control Output Indicator (orange)
- ④ Present Value  
(red or green (programmable) for H5CX-A models, red for H5CX-A11 /-L models)  
Character height: 11.5 mm
- ⑤ Time Unit Display  
(Color is same as present value.):  
(If the time range is 0 min, 0 h, 0.0 h, or 0 h 0 min, this display flashes to indicate timing operation.)
- ⑥ Set Value (green)  
Character height: 6 mm
- ⑦ Set Value 1, 2 Display

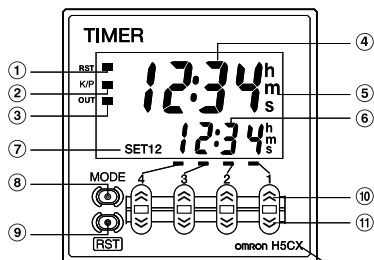

Front View

Front color: Black

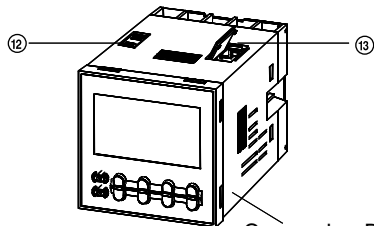

Case color: Black

## Operation Key

- ⑧ Mode Key  
(Changes modes and setting items)
- ⑨ Reset Key  
(Resets present value and output)
- ⑩ Up Keys 1 to 4
- ⑪ Down Keys 1 to 4

## Switches

- ⑫ Key-protect Switch  
(Default setting) OFF ← ON
- ⑬ DIP Switch  
1 2 3 4 5 6 7 8

**Note 1:** All the pins are factory-set to OFF.  
**Note 2:** There is no DIP switch on the H5CX-L8□.

# Dimensions

Note: All units are in millimeters unless otherwise indicated.

## ■ Dimensions without Flush Mounting Adapter

### H5CX-A/-AS (Flush Mounting Models)

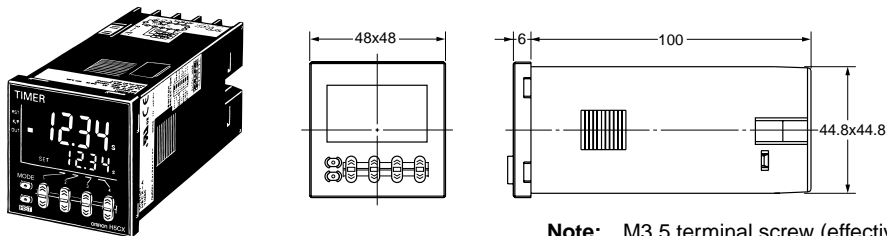

Note: M3.5 terminal screw (effective length: 6 mm)

### H5CX-AD/-ASD (Flush Mounting Models)

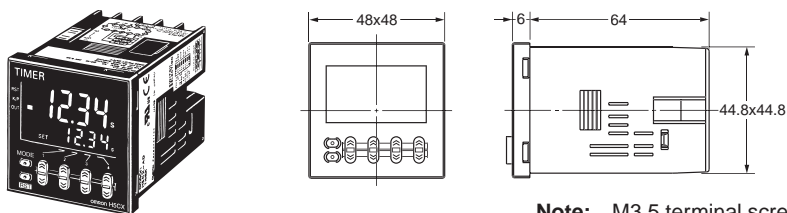

Note: M3.5 terminal screw (effective length: 6 mm)

### H5CX-A11/-A11S (Flush Mounting/Surface Mounting Models)

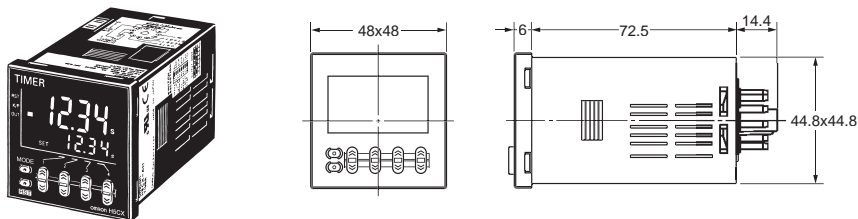

### H5CX-A11D/-A11SD (Flush Mounting/Surface Mounting Models)

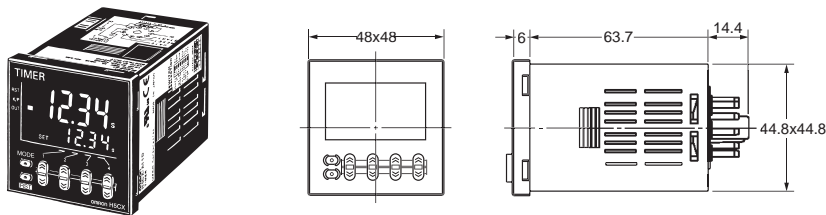

### H5CX-L8□ (Flush Mounting/Surface Mounting Models)

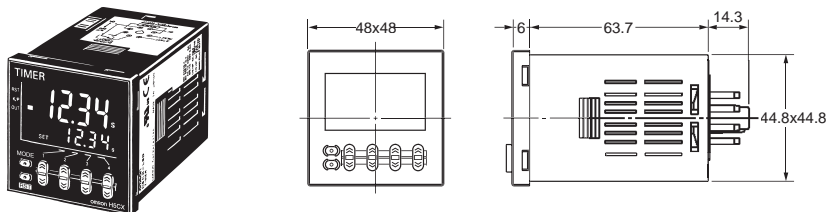

## ■ Dimensions with Flush Mounting Adapter

### H5CX-A/-AS (Provided with Adapter and Waterproof Packing)

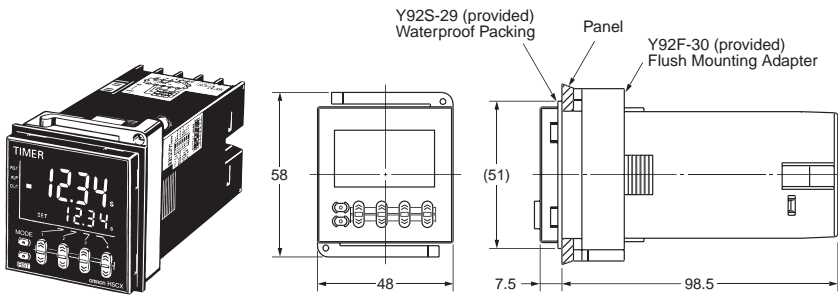

### H5CX-AD/-ASD (Provided with Adapter and Waterproof Packing)

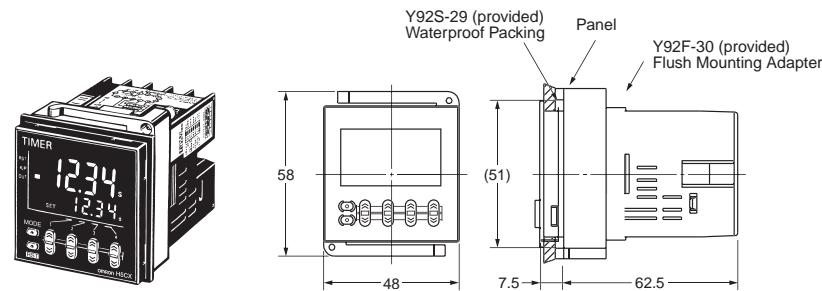

### H5CX-A11/-A11S (Adapter and Waterproof Packing Ordered Separately)

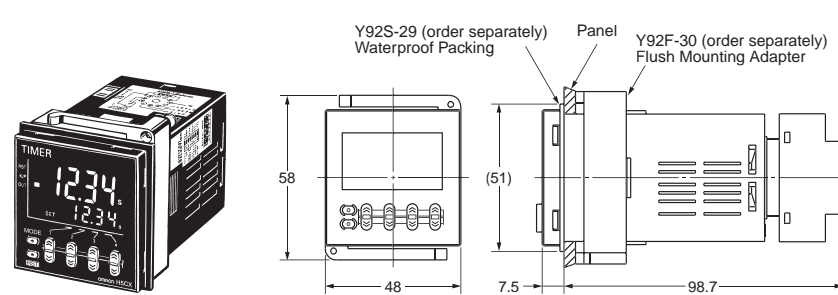

#### Panel Cutouts

Panel cutouts areas shown below. (according to DIN43700).

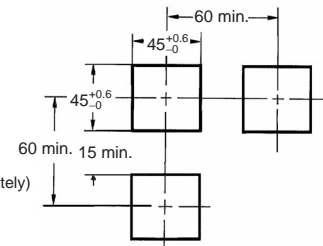

- Note**
1. The mounting panel thickness should be 1 to 5 mm.
  2. To allow easier operability, it is recommended that Adapters are mounted so that the gap between sides with hooks is at least 15 mm.
  3. It is possible to mount timers side by side, but only in the direction without the hooks.

### H5CX-A11D/-A11SD (Adapter and Waterproof Packing Ordered Separately)

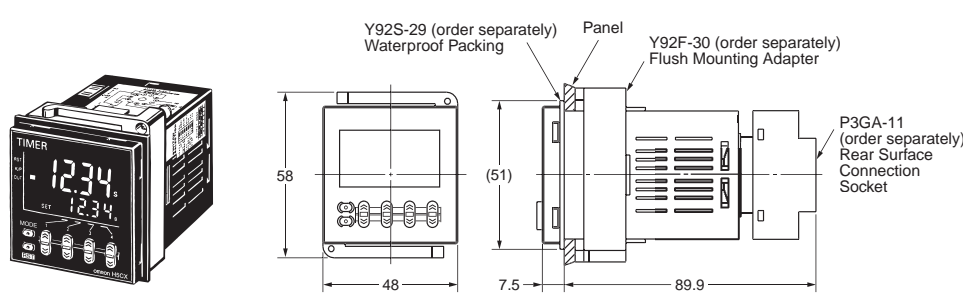

n side by side mounting

A

$$A = (48n - 2.5) \begin{matrix} +1 \\ 0 \end{matrix}$$

With Y92A-48F1 attached.  

$$A = \{48n - 2.5 + (n-1) \times 4\} \begin{matrix} +1 \\ 0 \end{matrix}$$

With Y92A-48 attached.  

$$A = (51n - 5.5) \begin{matrix} +1 \\ 0 \end{matrix}$$

### H5CX-L8 (Adapter and Waterproof Packing Ordered Separately)

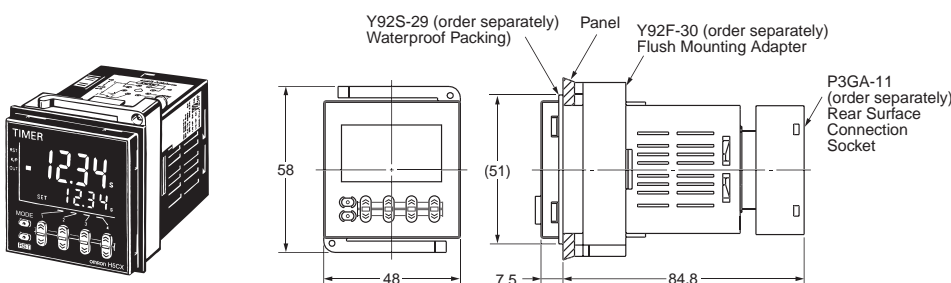

## ■ Dimensions with Front Connecting Socket

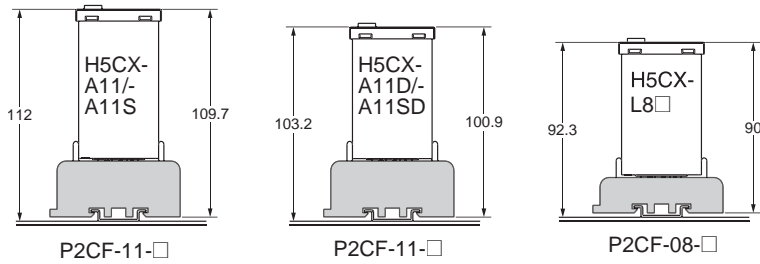

**Note:** These dimensions vary with the kind of DIN track (reference value).

## ■ Accessories (Order Separately)

**Note:** All units are in millimeters unless otherwise indicated.

### Track Mounting/Front Connecting Socket

#### P2CF-08

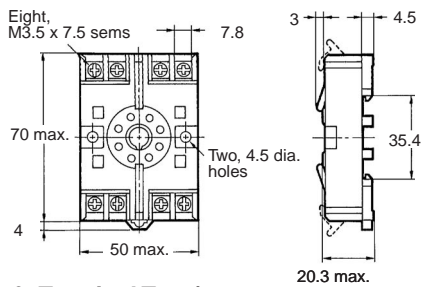
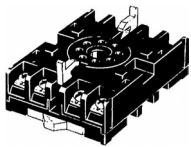

### Terminal Arrangement/ Internal Connections (Top View)

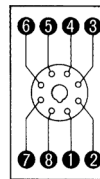

### Surface Mounting Holes

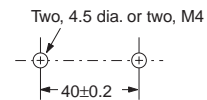

#### P2CF-08-E (Finger Safe Terminal Type) Conforming to VDE0106/P100

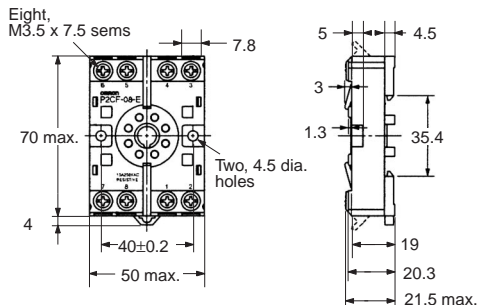
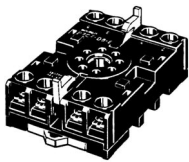

**Track Mounting/Front Connecting Socket**

**P2CF-11**

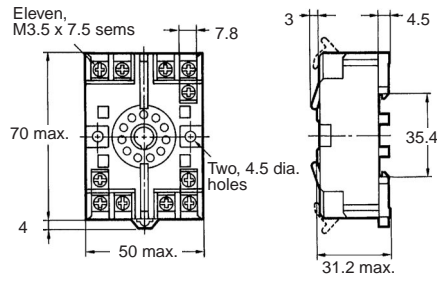
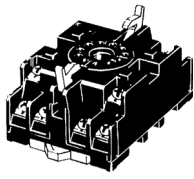

**Terminal Arrangement/  
Internal Connections  
(Top View)**

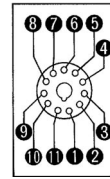

**Surface Mounting Holes**

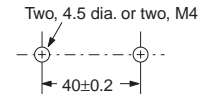

**P2CF-11-E (Finger Safe Terminal Type)  
Conforming to VDE0106/P100**

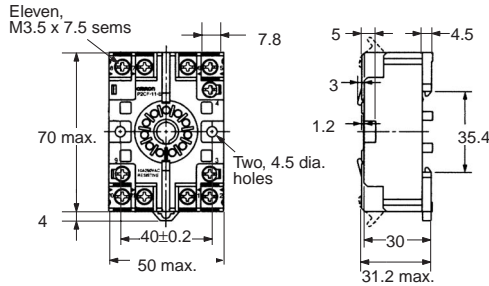
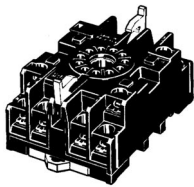

**Back Connecting Socket**

**P3G-08**

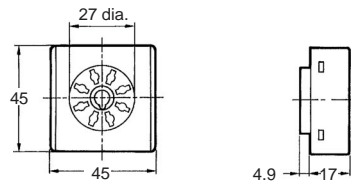
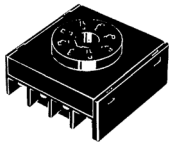

**Terminal Arrangement/  
Internal Connections  
(Bottom View)**

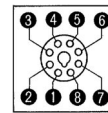

**P3GA-11**

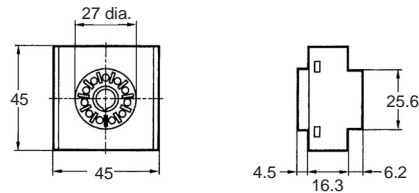
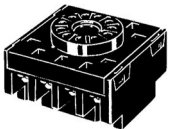

**Terminal Arrangement/  
Internal Connections  
(Bottom View)**

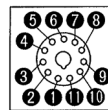

**Finger Safe Terminal Cover**

**Conforming to VDE0106/P100**

**Y92A-48G**

**(Attachment for P3G-08/P3GA-11  
Socket)**

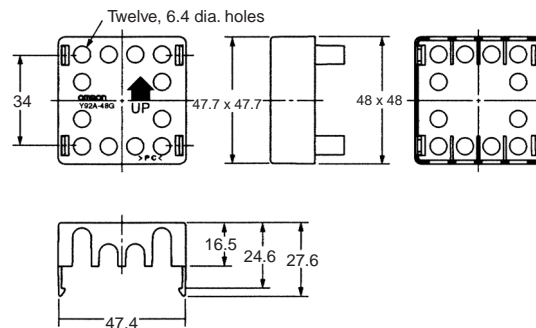
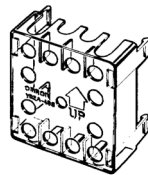

**Hard Cover**  
Y92A-48

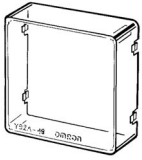

**Soft Cover**  
Y92A-48F1

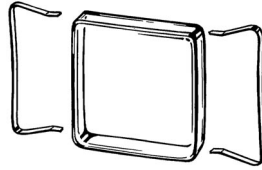

- Note:** 1. Depending on the operating environment, the condition of resin products may deteriorate, and may shrink or become harder. Therefore, it is recommended that resin products are replaced regularly.
2. The H5CX's panel surface is water-resistant (conforming to IP66) and so even if drops of water penetrate the gaps between the keys, there will be no adverse effect on internal circuits. If, however, there is a possibility of oil being present on the operator's hands, use the Soft Cover. The Soft Cover ensures protection equivalent to IP54F against oil. Do not, however, use the H5CX in locations where it would come in direct contact with oil.

**Flush Mounting Adapter**  
(provided with H5CX-A□ models)  
Y92F-30

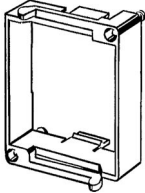

**Note:** Order the Flush Mounting Adapter separately if it is lost or damaged.

**Waterproof Packing**  
(provided with H5CX-A□ models)  
Y92S-29

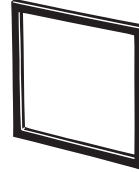

**Note:** Use Waterproof Packing to provide a level of water protection that complies with NEMA4, UL Type 4X, or IP66 standards. Order the Waterproof Packing separately if it is lost or damaged. Depending on the operating environment, the Waterproof Packing may deteriorate, contract, or harden and so regular replacement is recommended.

**Mounting Track**  
PFP-100N, PFP-50N

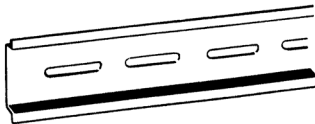

**PFP-100N2**

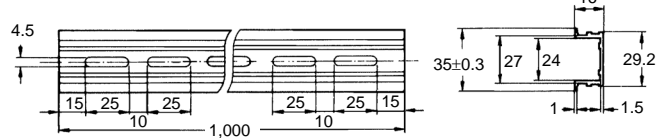
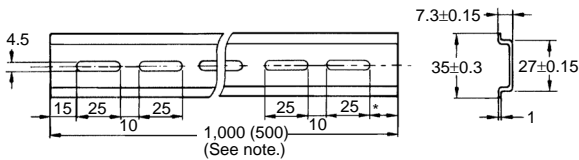
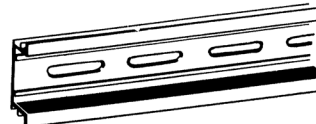

**Note:** The values shown in parentheses are for the PFP-50N.

**End Plate**  
PFP-M

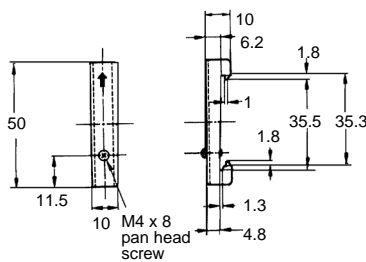
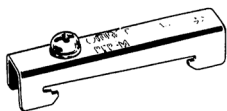

**Spacer**  
PFP-S

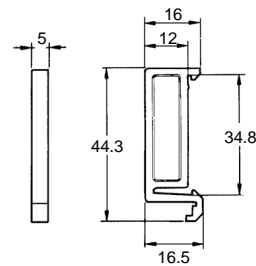
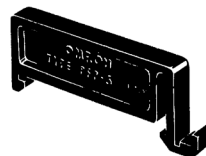



# Operating Procedures

## ■ Setting Procedure Guide

### Settings for Timer Operation

Use the following settings for all models except the H5CX-L8□.  
Refer to page 19 for the H5CX-L8□.

**When Using Basic Functions Only**

--- Basic Functions ---

- Time range (0.001 s to 999.9 h, except 9999 h and 9999min)
- Output mode (A, A-2, E, F)
- Timer mode (UP/DOWN)
- Input signal width (20 ms/1 ms)

The settings can be performed easily with the DIP switch.  
➡For details on the setting methods, refer to page 18.

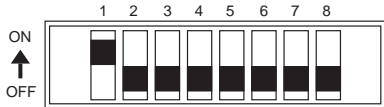

**When Using Other Time Ranges (9999 h, 9999 min) and Output Modes (A-1, A-3, b, b-1, d, and Z)**

All the functions can be set with the operation keys.  
➡For details on the setting methods, refer to page 19.

**When Using More Detailed Setting Items (Output Time, NPN/PNP Input Mode, Display Color, Key Protect Level)**

Setting for items other than the basic functions can be performed with the operation keys.  
➡For details on the setting methods, refer to page 19.

**Note:** At the time of delivery, the H5CX is set for timer operation.

### Settings for Twin Timer Operation

Use the following settings for all models except the H5CX-L8□.  
Refer to page 27 for the H5CX-L8□.

**When Using Basic Functions Only**

--- Basic Functions ---

- Time range (0.01 s to 99 min 59 s)
- ON/OFF start mode (flicker OFF start/flicker ON start)
- Timer mode (UP/DOWN)
- Input signal width (20 ms/1 ms)

The settings can be performed easily with the DIP switch.  
➡For details on the setting methods, refer to page 26.



**When Using Other Time Ranges (999.9 min, 9999 min, 99 h 59 min, 999.9 h, 9999 h, 9.999 s)**

All the functions can be set with the operation keys.  
➡For details on the setting methods, refer to page 27.

**When Using More Detailed Setting Items (NPN/PNP Input Mode, Display Color, Key Protect Level)**

Setting for items other than the basic functions can be performed with the operation keys.  
➡For details on the setting methods, refer to page 27.

**Note:** At the time of delivery, the H5CX is set for timer operation.

## ■ Operating Procedures (Timer Function)

### Settings for Basic Functions

Settings for basic functions can be performed with just the DIP switch.

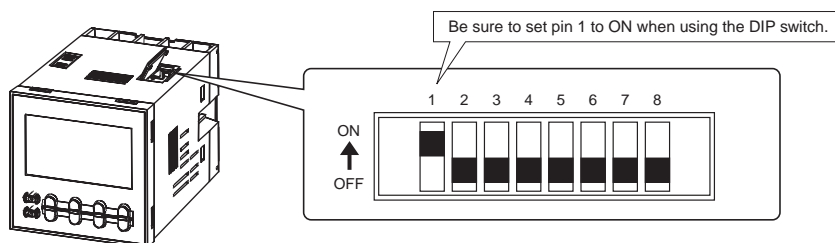

	Item	OFF	ON
1	DIP switch settings enable/disable	Disabled	Enabled
2	Time range	Refer to the table on the right.	
3			
4			
5	Output mode	Refer to the table on the right.	
6			
7	Timer mode	Elapsed time (UP)	Remaining time (DOWN)
8	Input signal width	20 ms	1 ms

Pin 2	Pin 3	Pin 4	Time range
ON	ON	ON	0.001 s to 9.999 s
OFF	OFF	OFF	0.01 s to 99.99 s
ON	OFF	OFF	0.1 s to 999.9 s
OFF	ON	OFF	1 s to 9999 s
ON	ON	OFF	0 min 01 s to 99 min 59 s
OFF	OFF	ON	0.1 min to 999.9 min
ON	OFF	ON	0 h 01 min to 99 h 59 min
OFF	ON	ON	0.1 h to 999.9 h

Note: All the pins are factory-set to OFF.

#### Easy Confirmation of Switch Settings Using Indicators

The ON/OFF status of the DIP switch pins can be confirmed using the front display. For details, refer to page 31.

Pin 5	Pin 6	Output mode
OFF	OFF	A mode (signal ON delay (I): power reset operation)
ON	OFF	A-2 mode: (power ON delay (I): power reset operation)
OFF	ON	E mode (interval: power reset operation)
ON	ON	F mode (accumulative: power hold operation)

- Note 1.** Be sure to set pin 1 of the DIP switch to ON. If it is set to OFF, the DIP switch settings will not be enabled.
- Changes to DIP switch settings are enabled when the power is turned ON. (Perform DIP switch settings while the power is OFF.)
  - There is no DIP switch on the H5CX-L8□. For details on the setting methods, refer to page 19.
  - When using time ranges or output modes that cannot be set with the DIP switch, all of the settings have to be made using the operation keys. For details on the setting methods, refer to page 19.

#### Detailed Settings

After making DIP switch settings for basic functions, detailed settings (see note) can be added using the operation keys. For details, refer to page 19.

**Note:** Output time, NPN/PNP input mode, display color, key protect level.

# Settings for Advanced Functions

Settings that cannot be performed with the DIP switch are performed with the operation keys.

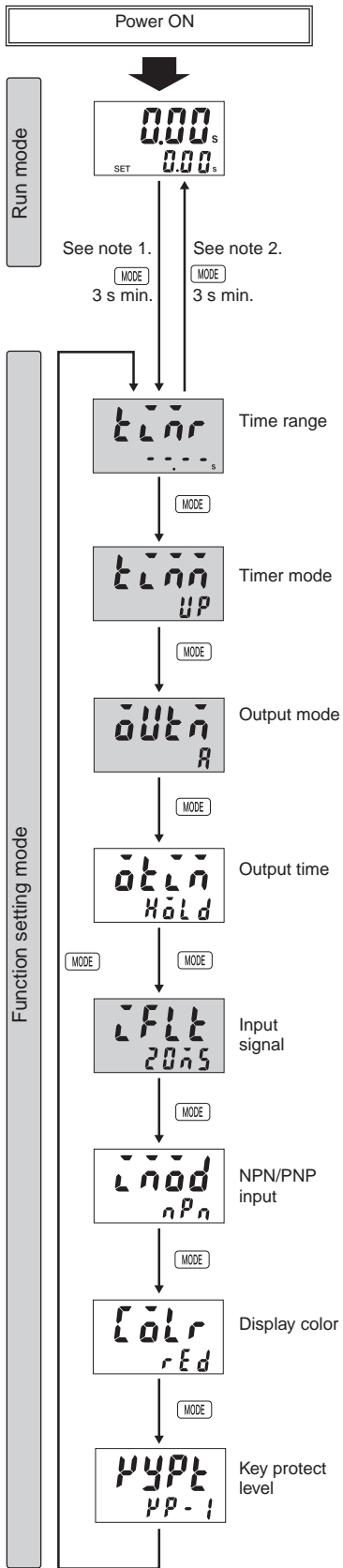

For details on operations in run mode, refer to page 21.

- Note 1.** If the mode is switched to the function setting mode during operation, operation will continue.
- 2.** Changes made to settings in function setting mode are enabled for the first time when the mode is changed to run mode. Also, when settings are changed, the timer is reset (time initialized and output turned OFF).

The characters displayed in reverse video are the default settings. When performing settings with operation keys only, set pin1 of the DIP switch to OFF (factory setting). If pin 1 of the DIP switch is set to ON, the setting items indicated in   will not be displayed.

Set the time range using the  $\leftarrow$   $\rightarrow$  keys.

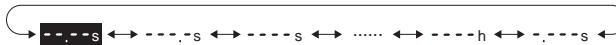

→ For details, refer to *Time Range List* below.

Set the timer mode using the  $\leftarrow$   $\rightarrow$  keys.

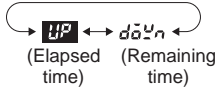

Set the output mode using the  $\leftarrow$   $\rightarrow$  keys.

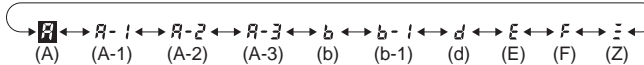

Set each digit for the output time using the corresponding  $\leftarrow$   $\rightarrow$  keys.

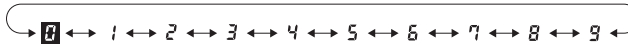

**Hold/0.01 ~ 99.99** : Output hold/0.01 to 99.99 s  
(If the output time is set to 0.00, *Hold* is displayed.)  
Displayed for modes A, A-1, A-2, A-3, b, and b-1 only.

Set the input signal width using the  $\leftarrow$   $\rightarrow$  keys.

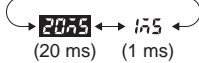

Set the NPN/PNP input mode using the  $\leftarrow$   $\rightarrow$  keys.

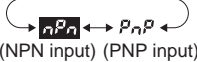

Only displayed for H5CX-A□ and H5CX-A11□ models.

Set the display color using the  $\leftarrow$   $\rightarrow$  keys.

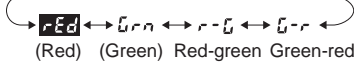

Displayed for terminal-block models (H5CX-A□) only.

Set the key protect level using the  $\leftarrow$   $\rightarrow$  keys.

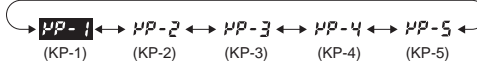

### Time Range List

Display	Set Value
00.00 s	0.01 s to 99.99 s (default setting)
00.0 s	0.1 s to 999.9 s
000 s	1 s to 9999 s
00:01 m	0 min 01 s to 99 min 59 s
00.1 m	0.1 min to 999.9 min
0000 m	1 min to 9999 min
00:01 h	0 h 01 min to 99 h 59 min
00.1 h	0.1 h to 999.9 h
0000 h	1 h to 9999 h
0.001 s	0.001 s to 9.999 s

## Explanation of Functions

### Time Range (t i m r) (Setting possible using DIP switch.)

Set the range to be timed in the range 0.000 s to 9,999 h. Settings of type ---- h (9,999 h) and ---- min (9,999 min) cannot, however, be made with the DIP switch. Use the operation keys if these settings are required.

### Timer Mode (t i m m) (Setting possible using DIP switch.)

Set either the elapsed time (UP) or remaining time (DOWN) mode.

### Output Mode (o u t m) (Setting possible using DIP switch.)

Set the output mode. The possible settings are A, A-1, A-2, A-3, b, b-1, d, E, F, and Z. Only output modes A, A-2, E, and F can be set using the DIP switch. Use the operation keys if a different setting is required. (For details on output mode operation, refer to "Timing Charts" on page 22.)

### Output Time (o t i m)

When using one-shot output, set the output time for one-shot output (0.01 to 99.99 s). One-shot output can be used only if the selected output mode is A, A-1, A-2, b, or b-1. If the output time is set to 0.00, h o l d is displayed, and the output is held.

### Key Protect Level (k y p t)

Set the key protect level.

When the key-protect switch is set to ON, it is possible to prevent setting errors by prohibiting the use of certain operation keys by specifying the key protect level (KP-1 to KP-5). The key protect indicator is lit while the key-protect switch is set to ON.

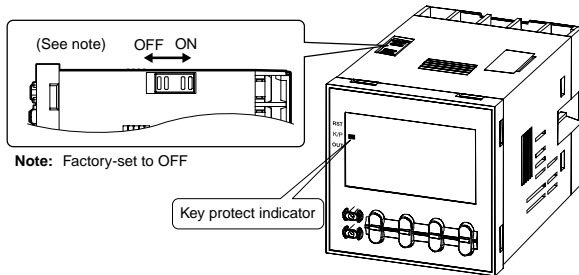

Level	Meaning	Details			
		Changing mode (See note.)	Switching display during operation	Reset key	Up/down key
KP-1 (default setting)		No	Yes	Yes	Yes
KP-2		No	Yes	No	Yes
KP-3		No	Yes	Yes	No
KP-4		No	Yes	No	No
KP-5		No	No	No	No

**Note:** Changing mode to timer/twin timer selection mode ( **MODE** + 1 s min.) or function setting mode ( **MODE** 3 s min.).

### Input Signal Width (i f l t) (Setting possible using DIP switch.)

Set the minimum signal input width (20 ms or 1 ms) for signal, reset, and gate inputs. The same setting is used for all external inputs (signal, reset, and gate inputs). If contacts are used for the input signal, set the input signal width to 20 ms. Processing to eliminate chattering is performed for this setting.

### NPN/PNP Input Mode (i m o d)

Select either NPN input (no-voltage input) or PNP input (voltage input) as the input format. The same setting is used for all external inputs. For details on input connections, refer to "Input Connections" on page 9.

### Display Color (c o l o r)

Set the color used for the present value.

	Output OFF	Output ON
red	Red (fixed)	
grn	Green (fixed)	
r-g	Red	Green
g-r	Green	Red

## Operation in Run Mode

### When Output Mode Is Not Z

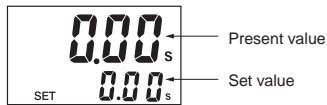

Set each digit for the set value using the corresponding  $\uparrow$   $\downarrow$  keys.



### When Output Mode Z Is Selected

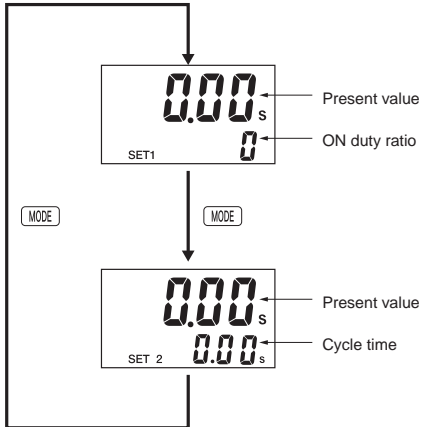

Set each digit for the ON duty ratio using the corresponding  $\uparrow$   $\downarrow$  keys. (The  $\uparrow$   $\downarrow$  keys for the 4th digit cannot be used.)



Set each digit for the cycle time using the corresponding  $\uparrow$   $\downarrow$  keys.



### Present Value and Set Value

These items are displayed when the power is turned ON. The present value is displayed in the main display and the set value is displayed in the sub-display. The values displayed will be determined by the settings made for the time range and the timer mode in function setting mode.

### Present Value and ON Duty Ratio (Output Mode = Z)

The present value is displayed in the main display and the ON duty ratio is displayed in the sub-display. "SET1" lights at the same time.

Set the ON duty ratio used in ON/OFF-duty adjustable flicker mode (Z) as a percentage.

If a cycle time is set, cyclic control can be performed in ON/OFF-duty adjustable flicker mode simply by changing the ON duty ratio.

$$\text{ON time} = \text{Cycle time} \times \frac{\text{ON duty ratio} (\%)}{100}$$

The output accuracy will vary with the time range, even if the ON duty ratio setting is the same. Therefore, if fine output time adjustment is required, it is recommended that the time range for the cycle time is set as small as possible.

#### Examples:

1. If the cycle time is 20 s, the ON duty ratio is 31%, and the time range is 1 s to 9999 s, the ON time is given by the following:

$$20 (\text{s}) \times \frac{31 (\%)}{100} = 6.2 (\text{s}) \rightarrow \text{Rounded off to the nearest integer}$$

(because of the time range setting)  $\rightarrow$  ON time = 6 s

2. If the cycle time is 20.00 s, the ON duty ratio is 31%, and the time range is 0.01 s to 99.99 s, the ON time is given by the following:

$$20.00 (\text{s}) \times \frac{31 (\%)}{100} = 6.200 (\text{s}) \rightarrow \text{Rounded off to 2 decimal places}$$

(because of the time range setting)  $\rightarrow$  ON time = 6.20 s

### Present Value and Cycle Time (Output Mode = Z)

The present value is displayed in the main display and the cycle time is displayed in the sub-display. "SET2" lights at the same time.

Set the cycle time used in ON/OFF-duty adjustable flicker mode (Z).

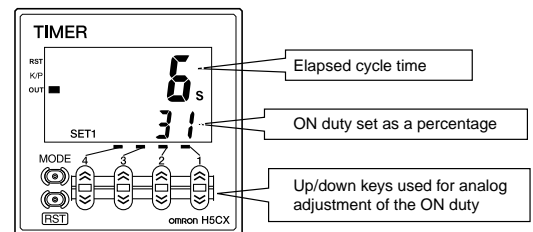

# Timing Charts

## Timer Operation

The gate input is not included in the H5CX-L8□ models.

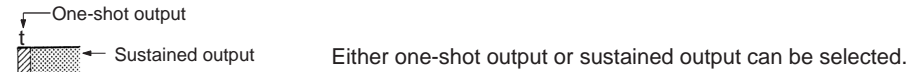

<b>Output mode A: Signal ON delay 1 (Timer resets when power comes ON.)</b>	
	<p>Timing starts when the start signal goes ON. While the start signal is ON, the timer starts when the power comes ON or when the reset input goes OFF. The control output is controlled using a sustained or one-shot time period.</p> <p><b>Basic Operation</b></p> <p>* Output is instantaneous when setting is 0. ** Start signal input is disabled during timing.</p>
<b>Output mode A-1: Signal ON delay 2 (Timer resets when power comes ON.)</b>	
	<p>Timing starts when the start signal goes ON, and is reset when the start signal goes OFF. While the start signal is ON, the timer starts when the power comes ON or when the reset input goes OFF. The control output is controlled using a sustained or one-shot time period.</p> <p><b>Basic Operation</b></p> <p>* Output is instantaneous when setting is 0.</p>
<b>Output mode A-2: Power ON delay 1 (Timer resets when power comes ON.)</b>	
	<p>Timing starts when the reset input goes OFF. The start signal disables the timing function (i.e., same function as the gate input). The control output is controlled using a sustained or one-shot time period.</p> <p><b>Basic Operation</b></p> <p>* Output is instantaneous when setting is 0.</p>
<b>Output mode A-3: Power ON delay 2 (Timer does not reset when power comes ON.)</b>	
	<p>Timing starts when the reset input goes OFF. The start signal disables the timing function (i.e., same function as the gate input). The control output is controlled using a sustained or one-shot time period.</p> <p><b>Basic Operation</b></p> <p>* Output is instantaneous when setting is 0.</p>

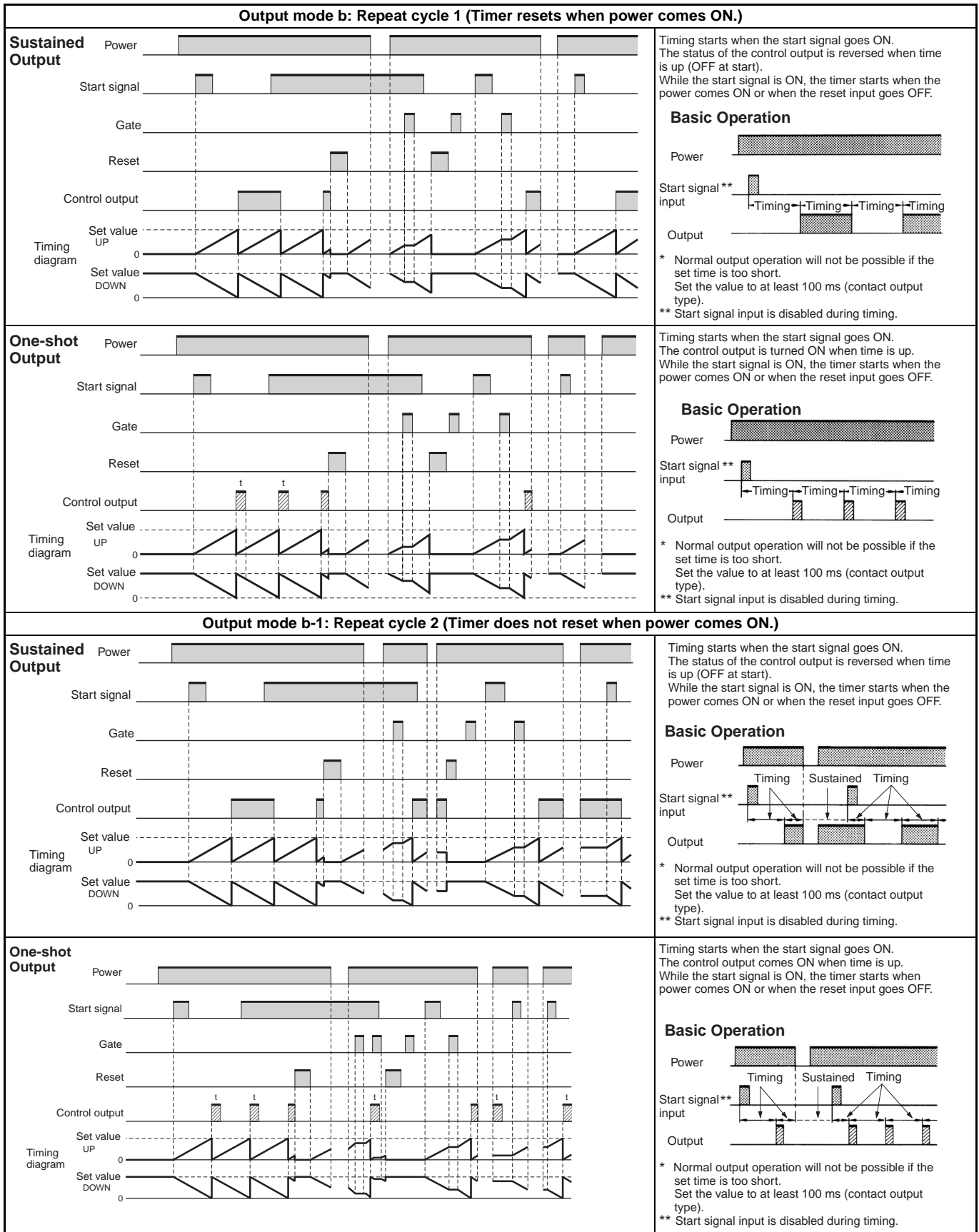

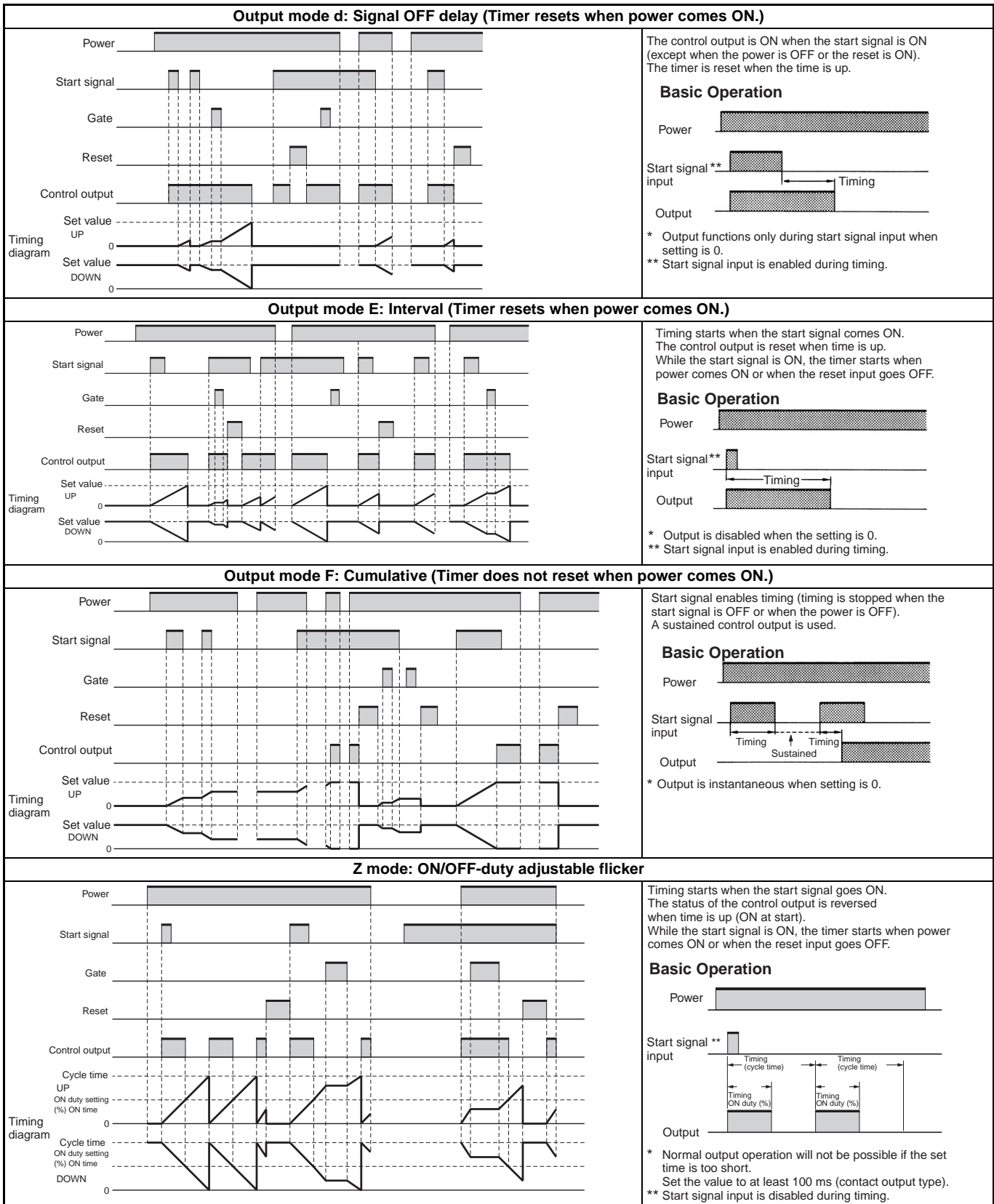

### Z Mode

Output quantity can be adjusted by changing the cycle time set in the adjustment level to 1 and by changing the ON duty (%) set value. The set value shows the ON duty (%) and can be set to a value between 0 and 100 (%). When the cycle time is 0, the output will always be OFF. When the cycle time is not 0 and when ON duty has been set to 0 (%), the output will always be OFF. When ON duty has been set to 100 (%), the output will always be ON.



## Self-diagnostic Function

The following displays will appear if an error occurs.

Main display	Sub-display	Error	Output status	Correction method	Set value after reset
e1	Not lit	CPU	OFF	Either press the reset key or reset the power supply.	No change
e2	Not lit	Memory error (RAM)	OFF	Reset the power supply.	No change
e2	sum	Memory error (EEP) (See note)	OFF	Reset to the factory settings using the reset key.	0

**Note:** This includes times when the life of the EEPROM has expired.

## ■ Operating Procedures (Twin Timer Function)

### Switching from Timer to Twin Timer

The H5CX is factory-set for timer operation. To switch to twin timer operation, use the procedure given below. For details, refer to page 32.

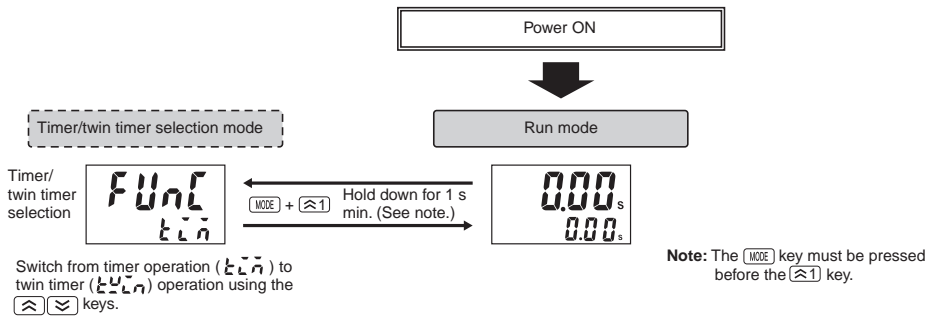

### Settings for Basic Functions

Settings for basic functions can be performed with just the DIP switch.

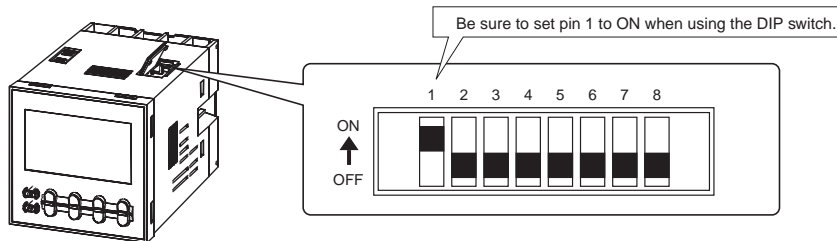

	Item	OFF	ON
1	DIP switch settings enable/disable	Disabled	Enabled
2	OFF time range	Refer to the table on the right.	
3			
4	ON time range	Refer to the table on the right.	
5			
6	ON/OFF start mode	Flicker OFF start	Flicker ON start
7	Timer mode	UP	DOWN
8	Input signal width	20 ms	1 ms

Pin 2	Pin 3	OFF time range
OFF	OFF	0.01 s to 99.99 s
ON	OFF	0.1 s to 999.9 s
OFF	ON	1 s to 9999 s
ON	ON	0 min 01 s to 99 min 59 s

Pin 4	Pin 5	ON time range
OFF	OFF	0.01 s to 99.99 s
ON	OFF	0.1 s to 999.9 s
OFF	ON	1 s to 9999 s
ON	ON	0 min 01 s to 99 min 59 s

Note: All the pins are factory-set to OFF.

#### Easy Confirmation of Switch Settings Using Indicators

The ON/OFF status of the DIP switch pins can be confirmed using the front display. For details, refer to page 31.

Note 1. Be sure to set pin 1 of the DIP switch to ON. If it is set to OFF, the DIP switch settings will not be enabled.

2. Changes to DIP switch settings are enabled when the power is turned ON. (Perform DIP switch settings while the power is OFF.)

3. There is no DIP switch on the H5CX-L8□. For details on the setting methods, refer to page 27.

4. When using time ranges that cannot be set with the DIP switch, all of the settings have to be made using the operation keys. For details on the setting methods, refer to page 27.

#### Detailed Settings

After making DIP switch settings for basic functions, detailed settings (see note) can be added using the operation keys. For details, refer to page 27.

Note: NPN/PNP input mode, display color, key protect level.



## Explanation of Functions

### OFF Time Range (oftr) (Setting possible using DIP switch.)

Set the time range for the OFF time in the range 0.000 s to 9,999 h. Only settings of type --.- s (99.99 s), ---. s (999.9 s), ---- s (9,999 s), and -- min -- s (99 min 59 s), however, can be made with the DIP switch. Use the operation keys if another type of setting is required.

### ON Time Range (ontr) (Setting possible using DIP switch.)

Set the time range for the ON time in the range 0.001 s to 9,999 h. Only settings of type --.- s (99.99 s), ---. s (999.9 s), ---- s (9,999 s), and -- min -- s (99 min 59 s), however, can be made with the DIP switch. Use the operation keys if another type of setting is required.

### Timer Mode (tim) (Setting possible using DIP switch.)

Set either UP (incremental) or DOWN (decremental) timer mode. In UP mode, the elapsed time is displayed, and in DOWN mode, the remaining time is displayed.

### ON/OFF Start Mode (totm) (Setting possible using DIP switch.)

Set the output mode. Set either flicker OFF start or flicker ON start. (For details on output mode operation, refer to "Timing Charts" on page 30.)

### Key Protect Level (kyp) (Setting possible using DIP switch.)

Set the key protect level.

When the key-protect switch is set to ON, it is possible to prevent setting errors by prohibiting the use of certain operation keys by specifying the key protect level (KP-1 to KP-5). The key protect indicator is lit while the key-protect switch is set to ON.

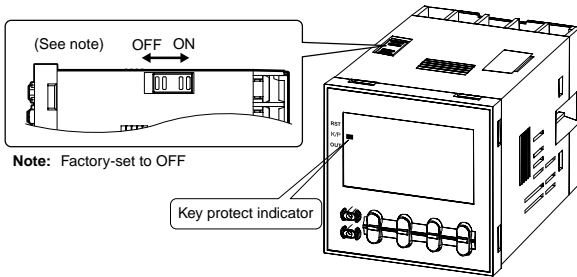

### Input Signal Width (iflt) (Setting possible using DIP switch.)

Set the minimum signal input width (20 ms or 1 ms) for signal, reset, and gate inputs. The same setting is used for all external inputs (signal, reset, and gate inputs). If contacts are used for the input signal, set the input signal width to 20 ms. Processing to eliminate chattering is performed for this setting.

### NPN/PNP Input Mode (imod)

Select either NPN input (no-voltage input) or PNP input (voltage input) as the input format. The same setting is used for all external inputs. For details on input connections, refer to "Input Connections" on page 9.

### Display Color (colr)

Set the color used for the present value.

	Output OFF	Output ON
red	Red (fixed)	
grn	Green (fixed)	
r-g	Red	Green
g-r	Green	Red

Level	Meaning	Details			
		Changing mode (See note.)	Switching display during operation	Reset key	Up/down key
KP-1 (default setting)		No	Yes	Yes	Yes
KP-2		No	Yes	No	Yes
KP-3		No	Yes	Yes	No
KP-4		No	Yes	No	No
KP-5		No	No	No	No

Note: Changing mode to timer/twin timer selection mode ( **MODE** + **↔** 1 s min.) or function setting mode ( **MODE** 3 s min.).

## Operation in Run Mode

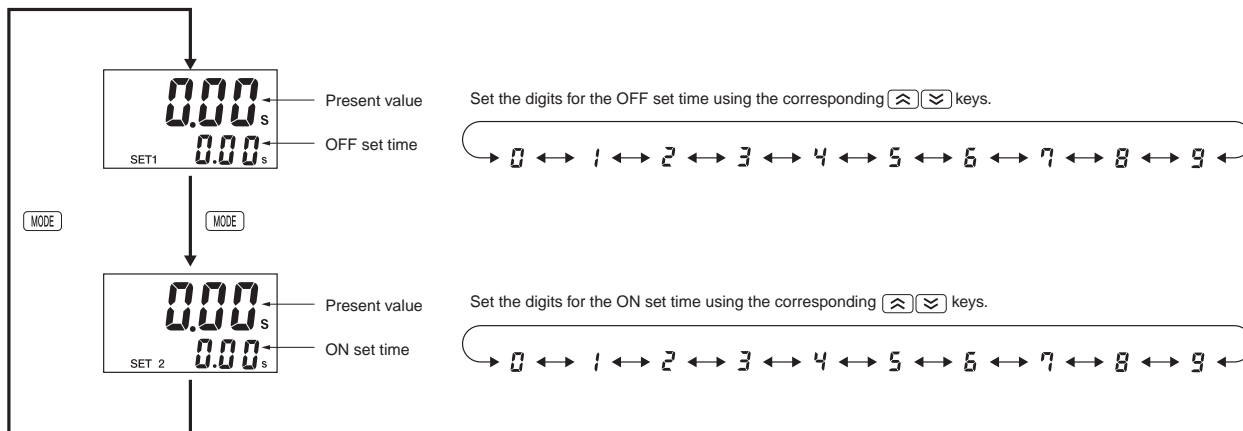

### Present Value and OFF Set Time

The present value is displayed in the main display and the OFF set time is displayed in the sub-display. "SET1" lights at the same time.

### Present Value and ON Set Time

The present value is displayed in the main display and the ON set time is displayed in the sub-display. "SET2" lights at the same time.

## Timing Charts

### Twin Timer Operation

The gate input is not included in the H5CX-L8□ models.

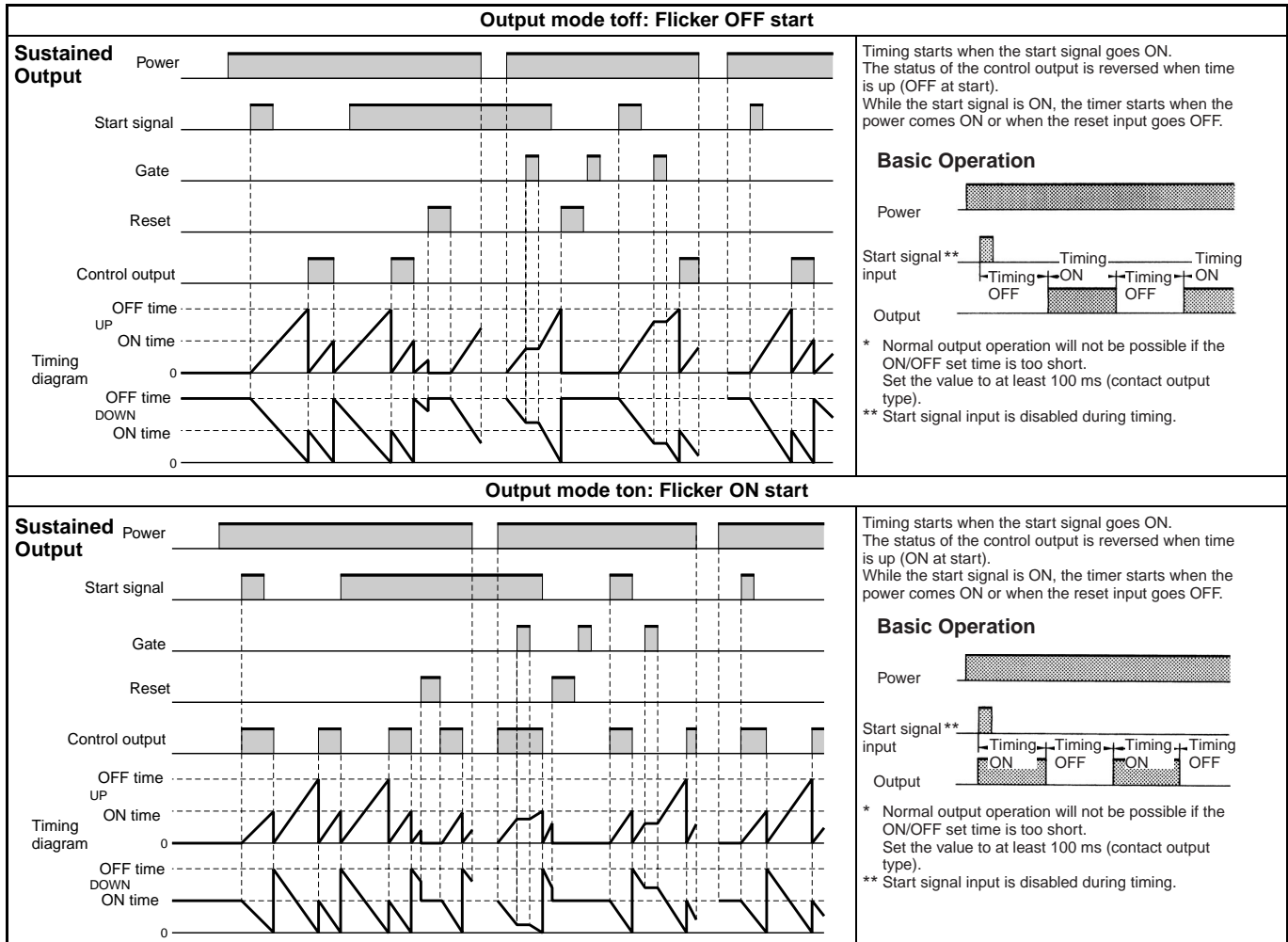

## Self-diagnostic Function

The following displays will appear if an error occurs.

Main display	Sub-display	Error	Output status	Correction method	Set value after reset
e1	Not lit	CPU	OFF	Either press the reset key or reset the power supply.	No change
e2	Not lit	Memory error (RAM)	OFF	Reset the power supply.	No change
e2	sum	Memory error (EEP) (See note)	OFF	Reset to the factory settings using the reset key.	0

**Note:** This includes times when the life of the EEPROM has expired.

## ■ Operation in Timer/Twin Timer Selection Mode

Select whether the H5CX is used as a timer or a twin timer in timer/twin timer selection mode. The H5CX is also equipped with a DIP switch monitor function, a convenient function that enables the settings of the DIP switch pins to be confirmed using the front display.

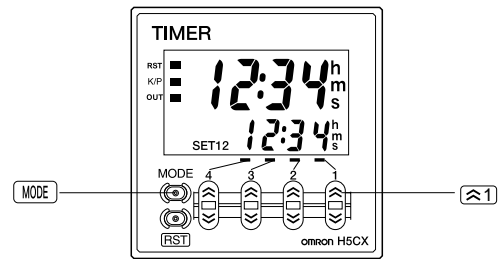
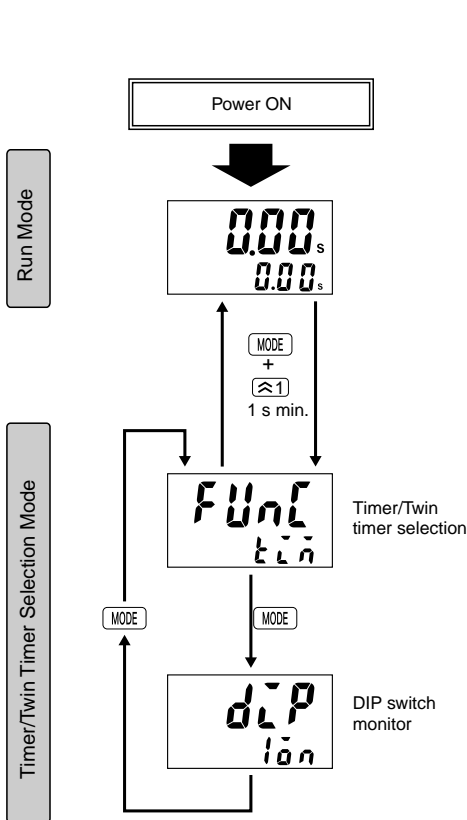

To change the mode to timer/twin timer selection mode, hold down the  $\approx 1$  key for 1 s min. with the MODE key held down. The MODE key must be pressed before the  $\approx 1$  key. If the  $\approx 1$  key is pressed first, the mode will not change.

Select either timer operation or twin timer operation using the  $\approx 1$  /  $\approx 2$  keys.

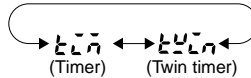

**Note:** The H5CX is factory-set for timer operation.

Confirm the status of DIP switch pins 1 to 8 using the  $\approx 1$  /  $\approx 2$  keys.

**Note 1.** This display is not supported with H5CX-L8□.

**2.** This display is only possible when DIP switch pin 1 (DIP switch settings enable/disable) is set to ON (enable).

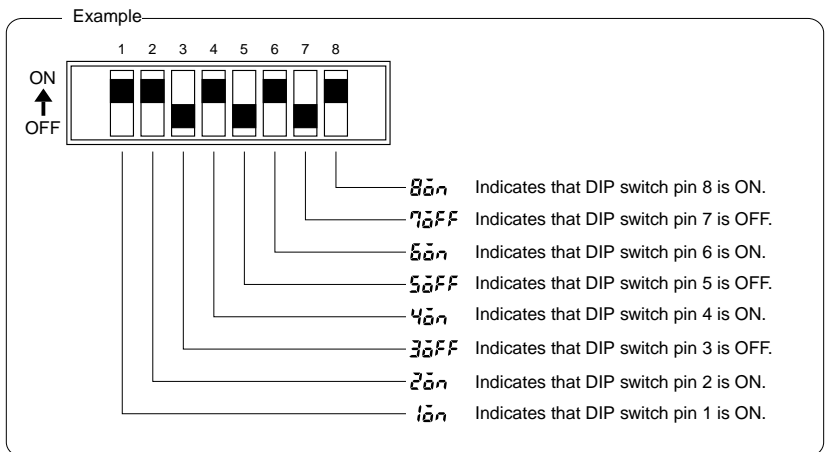

**Note 1.** When the mode is changed to timer/twin timer selection mode, the present value is reset and output turns OFF. Timing operation is not performed in timer/twin timer selection mode.

**2.** Setting changes made in timer/twin timer selection mode are enabled when the mode is changed to run mode. If settings are changed, the H5CX is automatically reset (present value initialized, output turned OFF).

# Additional Information

## ■ Using the Operation Keys

### Timer Operation

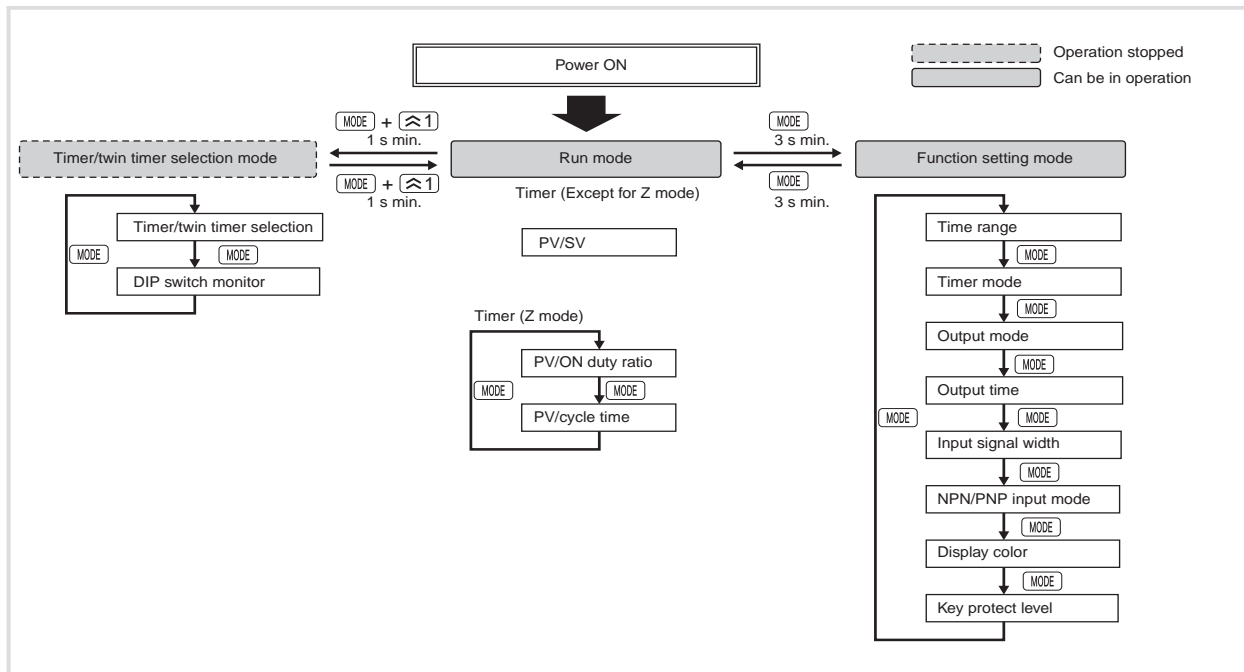

### Twin Timer Operation

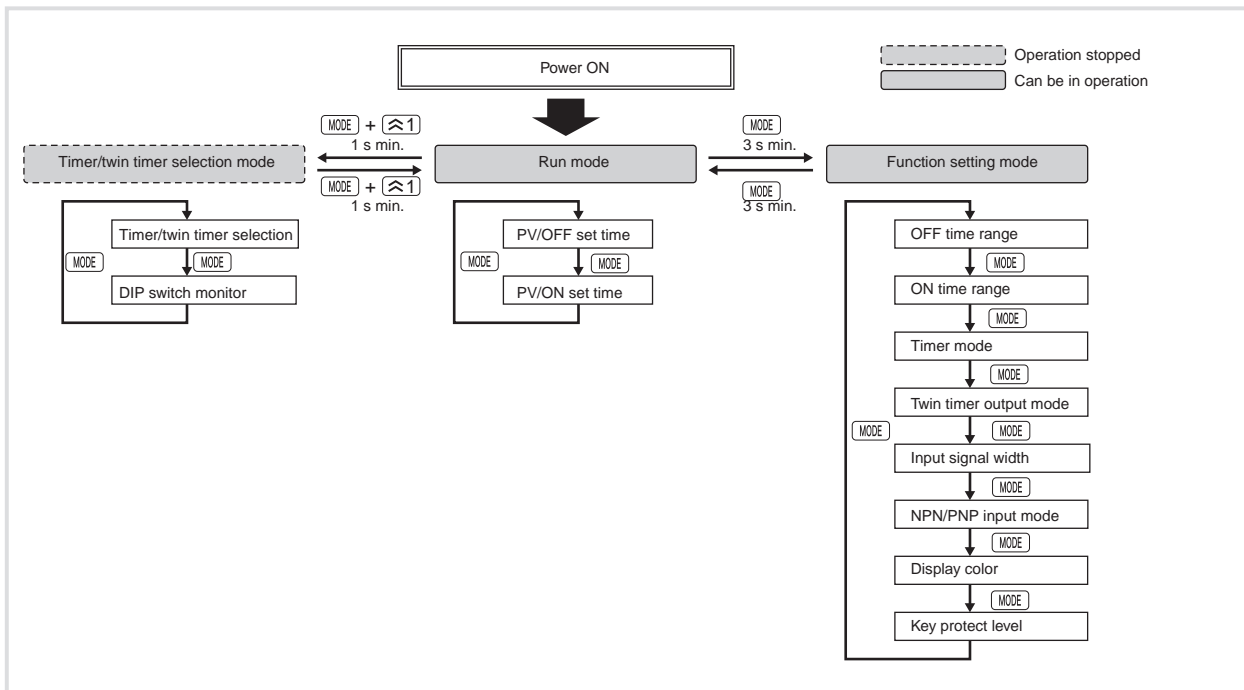

**Note 1.** All setting changes are performed using the **⇧** and **⇩** keys.

**Note 2.** The above flowcharts outline the procedure for all models. For details on specific models, refer to page 19 (timer operation) or page 27 (twin timer operation).



## ■ List of Settings

Fill in your set values in the set value column of the following tables and utilize the tables for quick reference.

### Timer/Twin Timer Selection Mode

Parameter name	Parameter	Setting range	Default value	Unit	Set value
Timer/Twin Timer selection	func	tim/twin	tim	---	
DIP switch monitor	dip	on/off	off	---	

### Settings for Timer Operation

#### Run Mode when Output Mode Is Not Z

Parameter name	Parameter	Setting range	Default value	Unit	Set value
Present value, set value	Set value	---	0.00 to 99.99 (Time range: --,--s)	0.00	s
		---	0.0 to 999.9 (Time range: ---,--s)	0.0	s
		---	0 to 9999 (Time range: ----s)	0	s
		---	0:00 to 99:59 (Time range: --min--s)	0:00	min; s
		---	0.0 to 999.9 (Time range: ---,-min)	0.0	min
		---	0 to 9999 (Time range: ----min)	0	min
		---	0:00 to 99:59 (Time range: --h--min)	0:00	h; min
		---	0.0 to 999.9 (Time range: ---,-h)	0.0	h
		---	0 to 9999 (Time range: ----h)	0	h
		---	0.000 to 9.999 (Time range: -,----s)	0.000	s
Present value	---	Same as set value	Same as left	Same as left	

#### Run Mode when Output Mode = Z

Parameter name	Parameter	Setting range	Default value	Unit	Set value
Present value, ON duty ratio	Cycle time	---	0.00 to 99.99 (Time range: --,--s)	0.00	s
		---	0.0 to 999.9 (Time range: ---,--s)	0.0	s
		---	0 to 9999 (Time range: ----s)	0	s
		---	0:00 to 99:59 (Time range: --min--s)	0:00	min; s
		---	0.0 to 999.9 (Time range: ---,-min)	0.0	min
		---	0 to 9999 (Time range: ----min)	0	min
		---	0:00 to 99:59 (Time range: --h--min)	0:00	h; min
		---	0.0 to 999.9 (Time range: ---,-h)	0.0	h
		---	0 to 9999 (Time range: ----h)	0	h
		---	0.000 to 9.999 (Time range: -,----s)	0.000	s
	ON duty ratio	---	0 to 100	0	%
Present value, cycle time	Present value	---	Same as cycle time above	Same as left	Same as left
	Present value	---	Same as cycle time above	Same as left	Same as left

### Function Setting Mode

Parameter name	Parameter	Setting range	Default value	Unit	Set value
Time range	timr	--,--s/---,--s/----s/--min--s/---,-min/----min/h--min/---,-h/----h/-,---s	---s	---	
Timer mode	timm	up/down	up	---	
Output mode	outm	a/a-1/a-2/a-3/b/b-1/d/e/f/=	a	---	
Output time	otim	hold/0.01 to 99.99	hold	s	
Input signal width	iflt	20ms/1ms	20ms	---	
NPN/PNP input mode	imod	npn/npn	npn	---	
Display color	colr	red/org/r-o/o-r	red	---	
Key protect level	kypt	kp-1/kp-2/kp-3/kp-4/kp-5	kp-1	---	

## Settings for Twin Timer Operation

### Run Mode

Parameter name		Parameter	Setting range	Default value	Unit	Set value
Present value, OFF set time	OFF set time	---	0.00 to 99.99 (Time range: --,--s)	0.00	s	
		---	0.0 to 999.9 (Time range: ---,-s)	0.0	s	
		---	0 to 9999 (Time range: ----s)	0	s	
		---	0:00 to 99:59 (Time range: --min--s)	0:00	min; s	
		---	0.0 to 999.9 (Time range: ---,-min)	0.0	min	
		---	0 to 9999 (Time range: ----min)	0	min	
		---	0:00 to 99:59 (Time range: --h--min)	0:00	h; min	
		---	0.0 to 999.9 (Time range: ---,-h)	0.0	h	
		---	0 to 9999 (Time range: ----h)	0	h	
	---	0.000 to 9.999 (Time range: -,---s)	0.000	s		
	Present value	---	Same as OFF set time above	Same as left	Same as left	
Present value, ON set time	ON set time	---	Same as OFF set time above	Same as left	Same as left	
	Present value	---	Same as OFF set time above	Same as left	Same as left	

### Function Setting Mode

Parameter name	Parameter	Setting range	Default value	Unit	Set value
OFF time range	oftr	--.-s/---.s/----s/--min--s/---.min/----min/ --h--min/---.h/---h/-.---s	--.-s	---	
ON time range	ontr	--.-s/---.s/----s/--min--s/---.min/----min/ --h--min/---.h/---h/-.---s	--.-s	---	
Timer mode	tim	up/down	up	---	
ON/OFF start mode	totm	toff/ton	toff	---	
Input signal width	iflt	20ms/1ms	20ms	---	
NPN/PNP input mode	imod	nprn/pnp	nprn	---	
Display color	colr	red/grn/r-g/g-r	red	---	
Key protect level	kypt	kp-1/kp-2/kp-3/kp-4/kp-5	kp-1	---	

# 2-stage Digital Timer H5CX-B

## DIN 48 × 48-mm Digital Timer with 6-digit Display and Forecast Output

- Times the daily operating hours of machinery and tools, predicting and notifying when maintenance is required.
- The 2-stage settings and forecast output are ideal for maintenance applications.
- All settings can be performed easily with a DIP switch.
- PNP/NPN switchable DC-voltage input.



### Contents

Model Number Structure .....	36
Ordering Information.....	36
Specifications .....	37
Connections.....	39
Nomenclature .....	42
Dimensions.....	43
Operating Procedures .....	44

# Model Number Structure

---

## ■ Model Number Legend

**H5CX-BWSD**  
 1 2 3 4

**1. Type classifier**

B: 6-digit display type

**2. Stage setting**

W: 2-stage setting

**3. Output type**

S: Transistor output

**4. Supply voltage**

D: 12 to 24 VDC

## Ordering Information

---

### ■ List of Models

Output type	Supply voltage	6-digit display
		Screw terminals
Transistor	12 to 24 VDC	H5CX-BWSD

### ■ Accessories (Order Separately)

Name	Models
Flush Mounting Adapter (See note.)	Y92F-30
Waterproof Packing (See note.)	Y92S-29
Hard Cover	Y92A-48
Soft Cover	Y92A-48F1

**Note:** Supplied with H5CX-BWSD.

# Specifications

## ■ Ratings

Item	H5CX-BWSD
Classification	Digital timer
Rated supply voltage	12 to 24 VDC (permissible ripple: 20% (p-p) max.)
Operating voltage range	90% to 110% rated supply voltage
Power consumption (See note 1.)	Approx. 2.3 W at 12 VDC
Mounting method	Flush mounting
External connections	Screw terminals
Terminal screw tightening torque	0.5 N·m max.
Display (See note 2.)	7-segment, negative transmissive LCD; Present value: 9-mm-high characters, red Set value: 6-mm-high characters, green
Digits	6 digits
Time ranges	9999.99 s (0.01-s unit), 99 h 59 min 59 s (1-s unit), 99999.9 min (0.1-min unit), 99999.9 h (0.1-h unit)
Timer mode	Elapsed time (Up)
Input signals	Signal, reset, gate
Input method	No-voltage input/voltage input (switchable) <b>No-voltage Input</b> ON impedance: 1 k $\Omega$ max. (Leakage current: 5 to 20 mA when 0 $\Omega$ ) ON residual voltage: 3 V max. OFF impedance: 100 k $\Omega$ min. <b>Voltage Input</b> High (logic) level: 4.5 to 30 VDC Low (logic) level: 0 to 2 VDC (Input resistance: approx. 4.7 k $\Omega$ )
Signal, reset, gate	Minimum input signal width: 1 or 20 ms (selectable, same for all input)
Reset system	Power resets (only for A mode), external and manual reset
Power reset	Minimum power-opening time: 0.5 s (except for F-1 mode)
Reset voltage	10% max. of rated supply voltage
Sensor waiting time	250 ms max. (Control output is turned OFF and no input is accepted during sensor waiting time.)
Output modes	A, F-1
Control output	Transistor output: NPN open collector, 100 mA at 30 VDC max. residual voltage: 1.5 VDC max. (Approx. 1 V) Leakage current: 0.1 mA max. Output category according to EN60947-5-2 (DC-13; 30 V 100 mA)
Key protection	Yes
Memory backup	EEPROM (overwrites: 100,000 times min.) that can store data for 10 years min.
Ambient temperature	Operating: -10 to 55°C (-10 to 50°C if timers are mounted side by side) (with no icing or condensation) Storage: -25 to 65°C (with no icing or condensation)
Ambient humidity	25% to 85%
Case color	Black (N1.5)
Attachments	Waterproof packing, flush mounting adapter, unit label

**Note 1.** Inrush current will flow for a short time when the power supply is turned ON. Refer to *Inrush Current (Reference Values)* on page 38.

**2.** The display is lit only when the power is ON.

## ■ Characteristics

Item	H5CX-BWSD
Accuracy of operating time and setting error (including temperature and voltage influences) (See note 1.)	Power-ON start: $\pm 0.02\% \pm 0.05$ s max. Rated against set value Signal start (minimum pulse width of 20 ms): $\pm 0.01\% \pm 0.03$ s max. Rated against set value Signal start (minimum pulse width of 1 ms): $\pm 0.01\% \pm 3$ ms max. If the set value is within the sensor waiting time at startup the control output of the H5CX will not turn ON until the sensor waiting time passes.
Insulation resistance	100 M $\Omega$ min. (at 500 VDC) between current-carrying terminal and exposed non-current-carrying metal parts
Dielectric strength	2,000 VAC, 50/60 Hz for 1 min between current-carrying metal parts and non-current-carrying metal parts 1,000 VAC, 50/60 Hz for 1 min between control output, power supply, and input circuit
Impulse withstand voltage	1.0 kV (between power terminals) 1.5 kV (between current-carrying terminal and exposed non-current-carrying metal parts)
Noise immunity	$\pm 480$ V (between power terminals) and $\pm 600$ V (between input terminals), square-wave noise by noise simulator (pulse width: 100 ns/1 $\mu$ s, 1-ns rise)
Static immunity	Destruction: 15 kV Malfunction: 8 kV
Vibration resistance	Destruction: 10 to 55 Hz with 0.75-mm single amplitude each in three directions, four cycles each (8 min per cycle) Malfunction: 10 to 55 Hz with 0.35-mm single amplitude each in three directions, four cycles each (8 min per cycle)
Shock resistance	Destruction: 294 m/s <sup>2</sup> each in three directions Malfunction: 98 m/s <sup>2</sup> each in three directions
Approved safety standards (See note 2.)	UL508/Listing, UL50 Type 4X for indoor use (enclosure rating), CSA C22.2 No. 14, conforms to EN61812-1 (Pollution degree 2/overvoltage category III) Conforms to VDE0106/P100 (finger protection).
EMC	(EMI) EN61812-1 Emission Enclosure: EN55011 Group 1 class A (EMS) EN61812-1 Immunity ESD: EN61000-4-2: 6 kV contact discharge (level 2) 8 kV air discharge (level 3) Immunity RF-interference: EN61000-4-3: 10 V/m (Amplitude-modulated, 80 MHz to 1 GHz) (level 3); 10 V/m (Pulse-modulated, 900 MHz $\pm 5$ MHz) (level 3) Immunity Conducted Disturbance: EN61000-4-6: 10 V (0.15 to 80 MHz) (level 3) Immunity Burst: EN61000-4-4: 2 kV power-line (level 3); 1 kV I/O signal-line (level 4) Immunity Surge: EN61000-4-5: 1 kV line to lines (power and output lines) (level 3); 2 kV line to ground (power and output lines) (level 3)
Degree of protection	Panel surface: IP66 and NEMA4 (indoors), and UL Type 4X (indoors) (See note 2.)
Weight	Approx. 140 g

**Note 1.** The values are based on the set value.

**2.** The Y92S-29 Waterproof Packing and Y92F-30 Flush Mounting Adapter are necessary to ensure IP66, NEMA4, and UL Type 4X waterproofing between the H5CX and installation panel.

## ■ Inrush Current (Reference Values)

Voltage	Applied voltage	Inrush current (peak value)	Time
12 to 24 VDC	26.4 VDC	6 A	1.2 ms

# Connections

## ■ Block Diagram

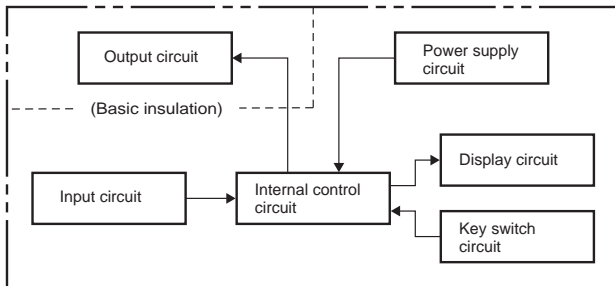

## ■ I/O Functions

<b>Inputs</b>	<b>Start signal</b>		Starts timing.
	<b>Reset</b>		Resets present value. (The present value returns to 0.) Timing stops and control output turns OFF while reset input is ON. Reset indicator is lit while reset input is ON.
	<b>Gate</b>		Inhibits timer operation.
<b>Outputs</b>	<b>Forecast value setting</b>	<b>Control output (OUT2)</b>	Turns ON when the present value reaches the set value.
		<b>Forecast output (OUT1)</b>	Turns ON when the present value reaches the forecast value. The forecast value = set value – forecast set value
	<b>Absolute value setting</b>	<b>Control output 2 (OUT2)</b>	Turns ON when the present value reaches set value 2.
		<b>Control output 1 (OUT1)</b>	Turns ON when the present value reaches set value 1.

## Terminal Arrangement

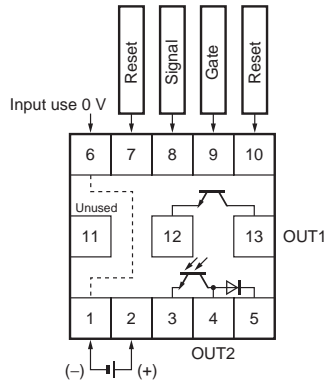

**Note 1.** Do not connect unused terminals as relay terminals.

2. The power supply and input circuit are not isolated.
3. Terminals 1 and 6 are connected internally.
4. Terminals 7 and 10 have the same reset function. The same function will be performed whichever terminal is connected. Terminals 7 and 10 are not connected internally, however, so do not use them for cross-over wiring.
5. Recommended lead wires: AWG18 to AWG24 (cross-sectional area: 0.205 to 0.823 mm<sup>2</sup>), single line or twisted-pair cable, made of copper or aluminum.

## Input Circuits

### Signal, Reset, and Gate Input

#### No-voltage Input (NPN Inputs)

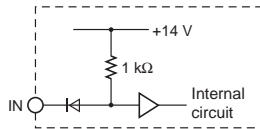

#### Voltage Inputs (PNP Inputs)

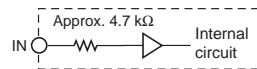



## Input Connections

The inputs of the H5CX-B are no-voltage (short-circuit or open) inputs or voltage inputs.

### No-voltage Inputs (NPN Inputs)

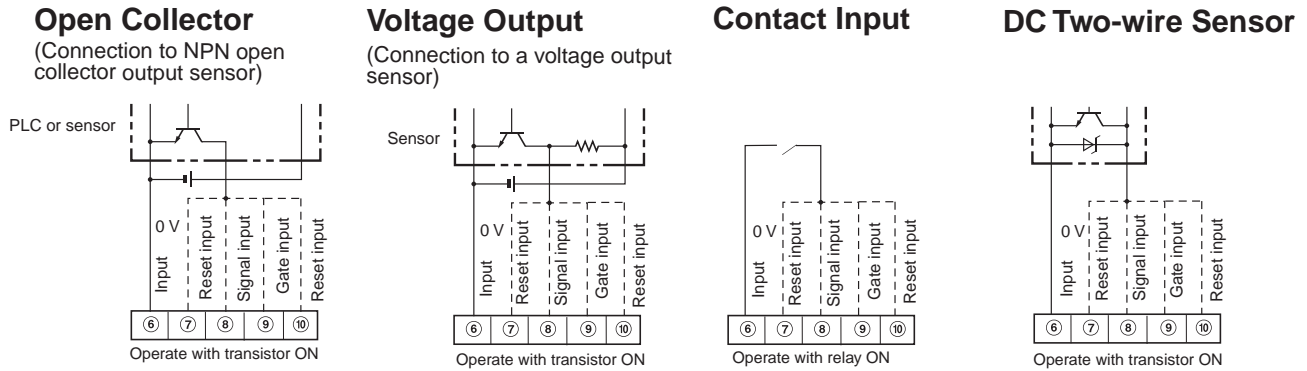

#### Applicable Two-wire Sensor

Leakage current: 1.5 mA max.  
 Switching capacity: 5 mA min.  
 Residual voltage: 3.0 VDC max.  
 Operating voltage: 10 VDC

### No-voltage Input Signal Levels

No-contact input	Short-circuit level Transistor ON Residual voltage: 3 V max. Impedance when ON: 1 kΩ max. (the leakage current is 5 to 20 mA when the impedance is 0 Ω)
	Open level Transistor OFF Impedance when OFF: 100 kΩ min.
Contact input	Use contact which can adequately switch 5 mA at 10 V

**Note:** The DC voltage must be 30 VDC max.

### Voltage Inputs (PNP Inputs)

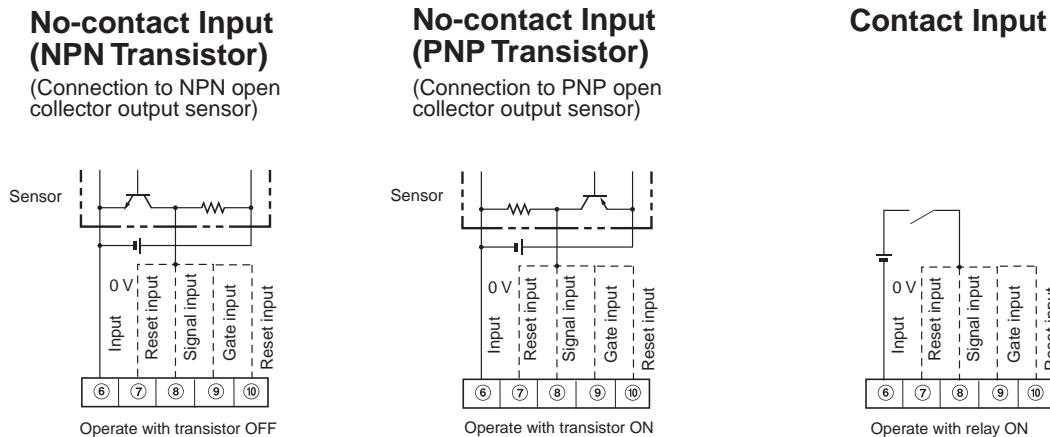

### Voltage Input Signal Levels

High level (Input ON): 4.5 to 30 VDC  
 Low level (Input OFF): 0 to 2 VDC  
 Input resistance: Approx. 4.7 kΩ

**Note:** The DC voltage must be 30 VDC max.

# Nomenclature

## Indicator

- ① Reset Indicator (orange)  
Lit when the reset input or Reset Key is ON.

---

- ② Key Protection Indicator (orange)  
Lit when the Key-protect Switch is ON.

---

- ③ Control Output Indicator (orange)  
Forecast value setting:  
Forecast output ON: [1] is lit  
Control output ON: [2] is lit  
Absolute value setting:  
Control output 1 ON: [1] is lit  
Control output 2 ON: [2] is lit

---

- ④ Present Value (red)  
Character height: 9 mm  
If the time range is 0.0 min or 0.0 h, the decimal point flashes to indicate timing operation.

---

- ⑤ Set Value (green)  
Character height: 6 mm

---

- ⑥ Set Value 1, 2 Display (green)

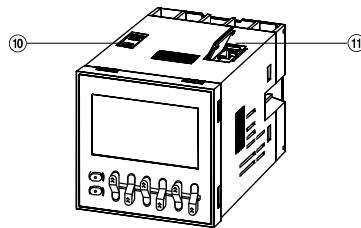
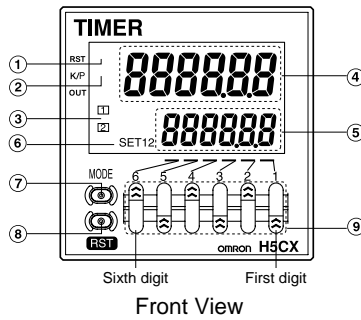

## Operation Key

- ⑦ Mode Key  
(Changes setting items)

---

- ⑧ Reset Key  
(Resets present value and output)

---

- ⑨ Up Keys 1 to 6

## Switches

- ⑩ Key-protect Switch

When the Key-protect Switch is ON, key operations are prohibited according to the settings for DIP switch pins 6 to 8, thus preventing setting errors. The Key-protect Switch can be turned ON and OFF while the power is ON. The Key Protection Indicator is lit orange when the Key-protect Switch is ON.

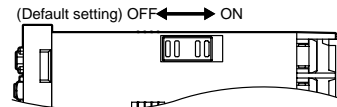

- ⑪ DIP Switch

Refer to *DIP Switch Settings* on page 45 for details on setting the DIP switch.



(Default setting)

## Unit Label

The unit label is included with the Unit. Affix the unit label in the position shown in the following diagram to match the time range to be used.

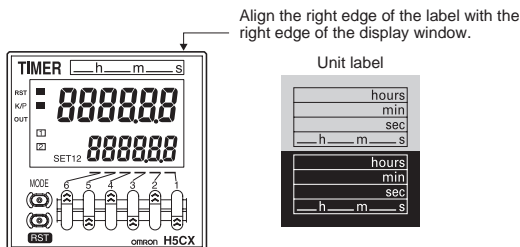

# Dimensions

Note: All units are in millimeters unless otherwise indicated.

## ■ Dimensions without Flush Mounting Adapter

### H5CX-BWSD (Flush Mounting Models)

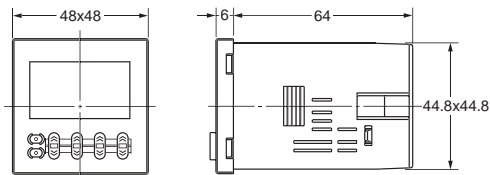
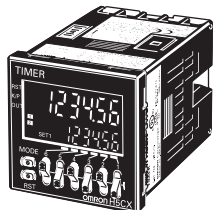

Note: M3.5 terminal screw (effective length: 6 mm)

### Panel Cutouts

Panel cutouts areas shown below. (according to DIN43700).

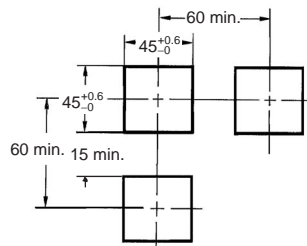

- Note
1. The mounting panel thickness should be 1 to 5 mm.
  2. To allow easier operability, it is recommended that Adapters are mounted so that the gap between sides with hooks is at least 15 mm.
  3. It is possible to mount timers side by side, but only in the direction without the hooks.

## ■ Dimensions with Flush Mounting Adapter

### H5CX-BWSD (Provided with Adapter and Waterproof Packing)

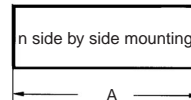
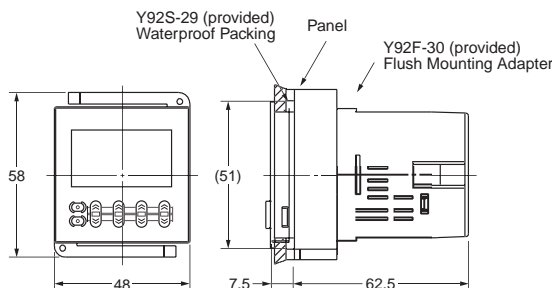
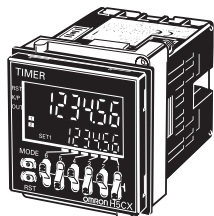

$$A = (48n - 2.5) \begin{matrix} +1 \\ 0 \end{matrix}$$

With Y92A-48F1 attached.  
 $A = (48n - 2.5 + (n-1) \times 4) \begin{matrix} +1 \\ 0 \end{matrix}$

With Y92A-48 attached.  
 $A = (51n - 5.5) \begin{matrix} +1 \\ 0 \end{matrix}$

## ■ Accessories (Order Separately)

### Hard Cover Y92A-48

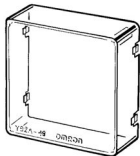

### Soft Cover Y92A-48F1

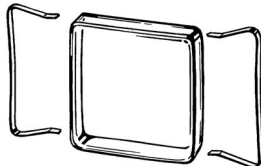

### Flush Mounting Adapter (provided with H5CX-BWSD)

Y92F-30

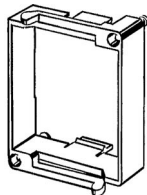

Note: Order the Flush Mounting Adapter separately if it is lost or damaged.

- Note:
1. Depending on the operating environment, the condition of resin products may deteriorate, and may shrink or become harder. Therefore, it is recommended that resin products are replaced regularly.
  2. The H5CX's panel surface is water-resistant (conforming to IP66) and so even if drops of water penetrate the gaps between the keys, there will be no adverse effect on internal circuits. If, however, there is a possibility of oil being present on the operator's hands, use the Soft Cover. The Soft Cover ensures protection equivalent to IP54F against oil. Do not, however, use the H5CX in locations where it would come in direct contact with oil.

### Waterproof Packing (provided with H5CX-BWSD)

Y92S-29

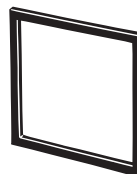

Note: Use Waterproof Packing to provide a level of water protection that complies with NEMA4, UL Type 4X, or IP66 standards. Order the Waterproof Packing separately if it is lost or damaged. Depending on the operating environment, the Waterproof Packing may deteriorate, contract, or harden and so regular replacement is recommended.

# Operating Procedures

## ■ Setting Set Values

Set values can be set either as offset values (forecast value setting) or absolute values. Set values are factory-set to forecast value setting.

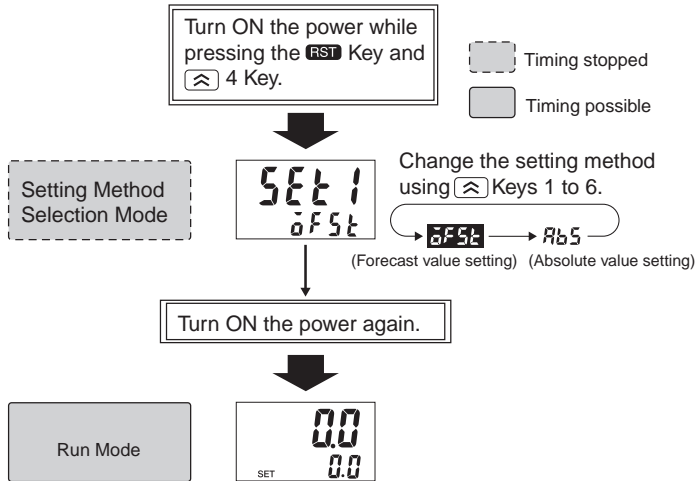

1. Move to Setting Method Selection Mode by turning ON the power while pressing both the **RST** Key and **4** Key at the same time.
2. Select forecast value setting (**offset**) or absolute value setting (**Abs**) using the **1-6** Keys.
3. When the power is turned ON again, the Timer will start with the selected setting method.

**Note 1:** In Setting Method Selection Mode, outputs are OFF and the timer is stopped.  
**2:** When the setting method is changed, the set values and present value are reset to 0, and outputs are OFF.

## Forecast Value Setting

Example: F-1 Mode

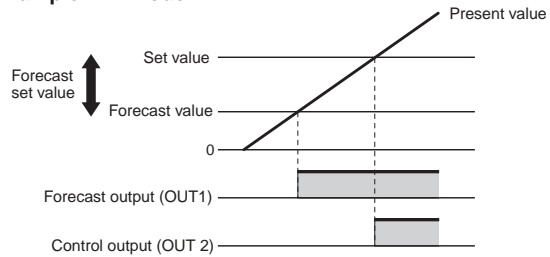

- OUT1 (forecast output) turns ON when the present value reaches the forecast value.  
 The forecast value = set value – forecast set value  
 The forecast set value is used to set the deviation for the set value.
- OUT2 (control output) turns ON when the present value reaches the set value.
- If the forecast set value  $\geq$  set value, OUT1 (forecast output) will turn ON as soon as timing starts.

## Absolute Value Setting

Example: F-1 Mode

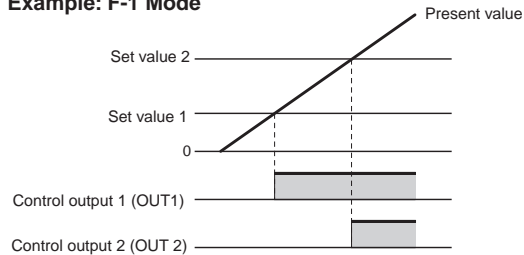

- OUT1 (control output 1) turns ON when the present value reaches set value 1.
- OUT2 (control output 2) turns ON when the present value reaches set value 2.

## DIP Switch Settings

All functions are set using the DIP switch.

	Item	OFF	ON
1	Time range	Refer to the table on the right.	
2			
3	Output mode	F-1 mode	A mode
4	Input signal width	20 ms	1 ms
5	NPN/PNP input mode	NPN	PNP
6	Reset Key protection	Disabled	Enabled
7	Up Key protection	Disabled	Enabled
8	Mode Key protection	Disabled	Enabled

Pin 1	Pin 2	Time range
OFF	OFF	0.1 h to 99999.9 h
ON	OFF	0.01 s to 9999.99 s
OFF	ON	0 h 00 min 01 s to 99 h 59 min 59 s
ON	ON	0.1 min to 99999.9 min

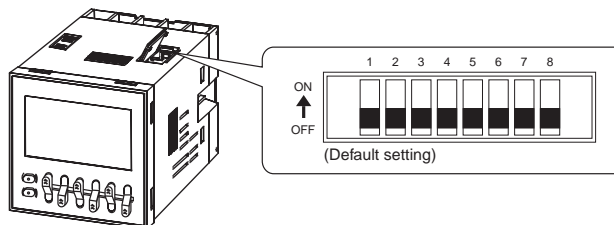

**Note 1:** All the pins are factory-set to OFF.

- 2:** DIP switch settings are effective when the power is turned ON again. (Set the DIP switch before installation and power-up.)
- 3:** The characters displayed in reverse video are the default settings.

## Operation in Run Mode

Set each digit for the set value using the corresponding Keys.



### Forecast Value Setting

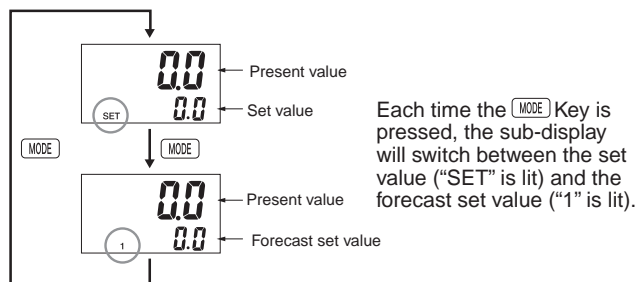

### Absolute Value Setting

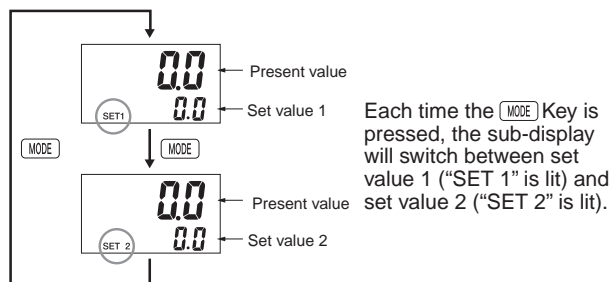

## ■ Timing Charts

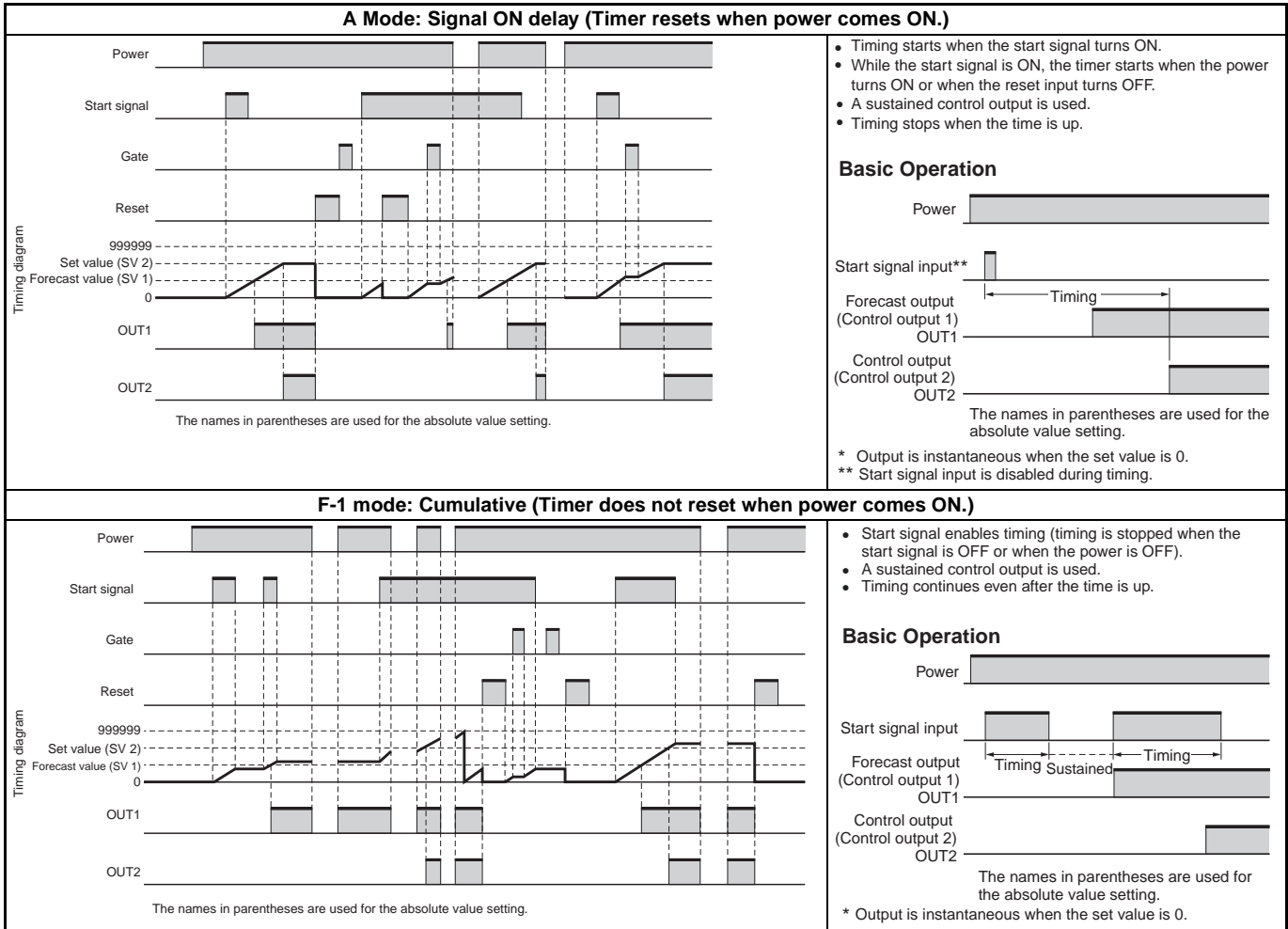

# Safety Precautions (Common)

**Note:** The following precautions are common for all H5CX models.

## CAUTION

Loose screws may occasionally result in fire or malfunction. Tighten the terminal screws securely. The recommended tightening torque is 0.5 N-m.

There may occasionally be a risk of explosion. Do not use the product where flammable or combustion gases are present.

This may occasionally cause electric shock, fire or malfunction. Never disassemble, repair or modify the product.

This may occasionally cause electric shock, fire or malfunction. Do not allow metal fragments or lead wire scraps to fall inside this product.

If both the power supply for the input device and that for the timer are not insulated, unwanted current from the AC power supply may occasionally burn out or damage the internal parts. Always use an insulated power supply for the timer.

## Precautions for Safe Use

The following precautions must be observed to ensure safety.

### Operating and Storage Conditions

- Do not use in locations affected by excessive vibration or shock, or in locations subject to exposure to water or oil.
- Do not use the product in locations subject to dust, corrosive gases, or direct sunlight.
- Separate the input signal devices, input signal cables, and the product from the source of noise or high-tension cables producing noise.
- Separate the product from the source of static electricity when using the product in an environment where a large amount of static electricity is produced (e.g., forming compounds, powders, or fluid materials being transported by pipe).
- Organic solvents (such as paint thinner), as well as very acidic or basic solutions might damage the outer casing of the H5CX.
- Use the product within the ratings specified for temperature and humidity.
- Do not use the product in locations where condensation may occur due to high humidity or where temperature changes are severe.
- Store at the specified temperature. If the H5CX has been stored at a temperature of less than  $-10^{\circ}\text{C}$ , allow the H5CX to stand at room temperature for at least 3 hours before use.

### Usage Precautions

- Make sure that the voltage applied is within the specified range, otherwise the internal elements of the counter may be damaged.
- The load current must be within the rated current.
- Ensure that the power is turned OFF before changing DIP switch settings. Changing DIP switch settings with the power turned ON may result in electric shock due to contact with terminals subject to high voltages.
- Pay attention to terminal polarity to ensure correct wiring.
- Make sure that the fluctuation of the supply voltage is within the permissible range.
- Apply the power supply voltage through a relay or switch in such a way that the voltage reaches the rated value within 2 s. If the voltage is applied gradually, the power may not be reset or unstable output operations may result.

- Leaving the H5CX with outputs ON at a high temperature for a long time may hasten the degradation of internal parts (such as electrolytic capacitors). Therefore, use the product in combination with relays and avoid leaving the product as long as more than 1 month with the output turned ON.

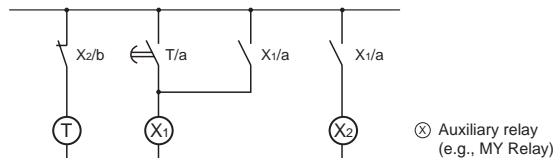

- When the product is operated with no-voltage input (NPN input), approximately 14 V is output from the input terminals, so connect a diode if the external power supply is less than 14 V.

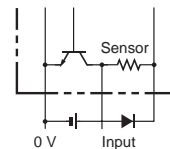

- Install a switch or circuit-breaker that allows the operator to immediately turn OFF the power, and make sure it is labeled clearly.
- The H5CX's panel surface is water-resistant (conforming to NEMA 4, UL Type 4X, and IP66). In order to prevent the internal circuit from water penetration through the space between the H5CX and operating panel, attach a waterproof packing (Y92S-29) between the H5CX and installation panel and secure the waterproof packing with the Y92F-30 Flush-mounting Adapter.

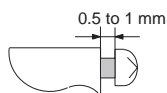

It is recommended that the space between the screw head and the adapter should be 0.5 to 1 mm.

- Tighten the two mounting screws on the Adapter. Tighten them alternately, a little at a time, so as to keep them at an equal tightness. If the panel screws are tightened unequally, water may ingress inside the panel.

## ■ Precautions for Correct Use

### Power Supplies

Turn the power ON and OFF using a relay with a rated capacity of 10 A minimum to prevent contact deterioration due to inrush current caused by turning the power ON and OFF.

Be sure that the capacity of the power supply is large enough, otherwise the Timer may not start due to inrush current that may flow for an instant when the Timer is turned on.

When turning the power ON and OFF, input signal reception is possible, unstable, or impossible as shown in the diagram below.

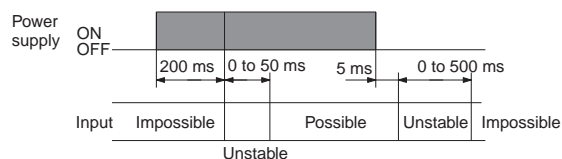

### Timer Control with Power Start

To allow for the startup time of peripheral devices (sensors, etc.), the H5CX starts timing operation between 200 ms to 250 ms after power is turned ON. For this reason, in operations where timing starts from power ON, the time display will actually start from 250 ms. If the set value is 249 ms or less, the time until output turns ON will be a fixed value between 200 and 250. (Normal operation is possible for set value of 250 ms or more.) In applications where a set value of 249 ms or less is required, use start timing with signal input.

When the H5CX is used with power start in F mode or F-1 mode (i.e., accumulative operation with output on hold), there will be a timer error (approximately 100 ms each time the H5CX is turned ON) due to the characteristics of the internal circuitry. Use the H5CX with signal start if timer accuracy is required.

### Transistor Output

The transistor output of the H5CX is insulated from the internal circuitry by a photocoupler, so the transistor output can be used as both NPN and PNP output.

#### NPN Output

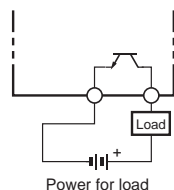

#### PNP Output

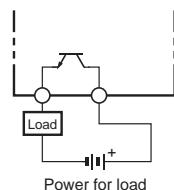

The diode connected to the collector of the output transistor is used to absorb inverted voltage that is generated when an inductive load is connected to the H5CX.

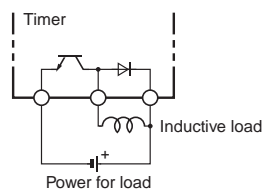

### Response Delay Time When Resetting (Transistor Output)

The following table shows the delay from when the reset signal is input until the output is turned OFF.

(Reference value)

Minimum reset signal width	Output delay time
1 ms	0.8 to 1.2 ms
20 ms	15 to 25 ms

### Power Failure Backup

All data is stored in the EEPROM when there is a power failure. The EEPROM can be overwritten more than 100,000 times.

Operating mode	Overwriting timing
A-3, b-1, F, F-1 mode	When power is turned OFF.
Other mode	When settings are changed.

## ■ Conformance to EN/IEC Standards

There is no insulation between power supply and input terminals (except for H5CX-A11/-A11S).

Basic insulation between power supply and output terminals, and between input terminals and output terminals.

When double insulation or reinforced insulation is required, apply double insulation or reinforced insulation defined in IEC 60664 that is suitable for the maximum operating voltage with clearances or solid insulation.



# Safety Precautions (H5CX-A/-L)

## CAUTION

If the output relay is used beyond its life expectancy, its contacts may occasionally become fused or there may occasionally be a risk of fire. The life expectancy of the output relay varies considerably according to its usage. Use the output relay within its rated load and electrical life expectancy.

Depending on the wiring, unwanted current from the AC power supply may occasionally burn out (damage) the internal parts.

The H5CX-A/-L (except for H5CX-A11/-A11S) do not have transformers. Therefore, there is no insulation between the power supply and input terminals, so make sure that wiring is correct before use.

For the power supply of an input device of the H5CX (except for H5CX-A11/-A11S), use an isolating transformer with the primary and secondary windings mutually isolated and the secondary winding not grounded.

### Correct Wiring Example

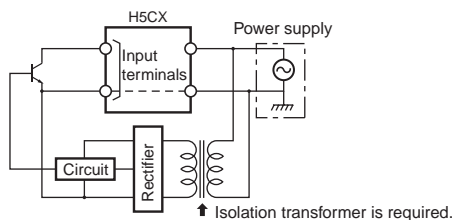

### Incorrect Wiring Example 1

Do not ground the secondary winding. If the secondary wiring is grounded, as shown in the following diagram, unwanted current may occasionally burn out or damage the internal parts.

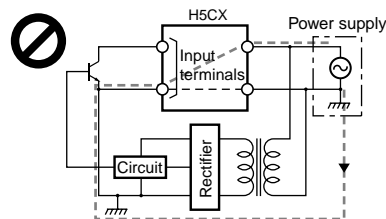

### Incorrect Wiring Example 2

Do not simultaneously input signals from a single input contact or a transistor to two or more timers that have independent power supplies. Otherwise, the internal parts may occasionally be burnt out or damaged by unwanted current, as shown in the following diagram.

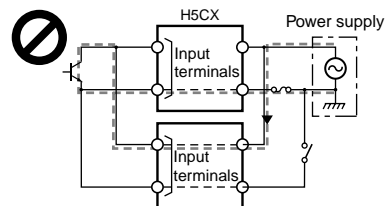

## Precautions for Safe Use

### Usage Precautions

Do not touch the input terminals while power is supplied. The H5CX (except for H5CX-A11/-A11S) has a transformerless power supply and so touching the input terminals with power supplied may result in electric shock.

### Changing the Set Values

When changing the set value during a timing operation, the output will turn ON if the set value is changed as follows because of the use of a constant read-in system:

Elapsed time (UP) mode: Present value  $\geq$  set value

Remaining time (DOWN) mode: Elapsed time  $\geq$  set value  
(The present value is set to 0.)

**Note:** When in the remaining time mode, the amount the set value is changed is added to or subtracted from the present value.

## Precautions for Correct Use

### Operation with a Set Value of 0

Operation with a set value of 0 will vary with the output mode. Refer to the *Timing Charts*.

# Safety Precautions (H5CX-B)

---

## ■ Precautions for Safe Use

### Changing the Set Value

When changing the set value during a timing operation, the output will turn ON if the set value is changed as follows because of the use of a constant read-in system:

#### **Forecast Value Setting**

When the present value  $\geq$  the set value, OUT2 (control output) turns ON. When the present value  $\geq$  the forecast value (forecast value = set value – forecast set value) OUT1 (forecast output) turns ON.

#### **Absolute Value Setting**

When the present value  $\geq$  set value 2, OUT2 (control output 2) turns ON. When the present value  $\geq$  set value 1, OUT1 (control output 1) turns ON.

## ■ Precautions for Correct Use

### Operation with a Set Value of 0

When the set value is 0, the output turns ON the moment the signal is input. The reset operation turns OFF the output.



# Warranty and Application Considerations

## Warranty and Limitations of Liability

### WARRANTY

OMRON's exclusive warranty is that the products are free from defects in materials and workmanship for a period of one year (or other period if specified) from date of sale by OMRON.

OMRON MAKES NO WARRANTY OR REPRESENTATION, EXPRESS OR IMPLIED, REGARDING NON-INFRINGEMENT, MERCHANTABILITY, OR FITNESS FOR PARTICULAR PURPOSE OF THE PRODUCTS. ANY BUYER OR USER ACKNOWLEDGES THAT THE BUYER OR USER ALONE HAS DETERMINED THAT THE PRODUCTS WILL SUITABLY MEET THE REQUIREMENTS OF THEIR INTENDED USE. OMRON DISCLAIMS ALL OTHER WARRANTIES, EXPRESS OR IMPLIED.

### LIMITATIONS OF LIABILITY

OMRON SHALL NOT BE RESPONSIBLE FOR SPECIAL, INDIRECT, OR CONSEQUENTIAL DAMAGES, LOSS OF PROFITS, OR COMMERCIAL LOSS IN ANY WAY CONNECTED WITH THE PRODUCTS, WHETHER SUCH CLAIM IS BASED ON CONTRACT, WARRANTY, NEGLIGENCE, OR STRICT LIABILITY.

In no event shall the responsibility of OMRON for any act exceed the individual price of the product on which liability is asserted.

IN NO EVENT SHALL OMRON BE RESPONSIBLE FOR WARRANTY, REPAIR, OR OTHER CLAIMS REGARDING THE PRODUCTS UNLESS OMRON'S ANALYSIS CONFIRMS THAT THE PRODUCTS WERE PROPERLY HANDLED, STORED, INSTALLED, AND MAINTAINED AND NOT SUBJECT TO CONTAMINATION, ABUSE, MISUSE, OR INAPPROPRIATE MODIFICATION OR REPAIR.

## Application Considerations

### SUITABILITY FOR USE

OMRON shall not be responsible for conformity with any standards, codes, or regulations that apply to the combination of products in the customer's application or use of the products.

Take all necessary steps to determine the suitability of the product for the systems, machines, and equipment with which it will be used.

Know and observe all prohibitions of use applicable to this product.

NEVER USE THE PRODUCTS FOR AN APPLICATION INVOLVING SERIOUS RISK TO LIFE OR PROPERTY WITHOUT ENSURING THAT THE SYSTEM AS A WHOLE HAS BEEN DESIGNED TO ADDRESS THE RISKS, AND THAT THE OMRON PRODUCTS ARE PROPERLY RATED AND INSTALLED FOR THE INTENDED USE WITHIN THE OVERALL EQUIPMENT OR SYSTEM.

## Disclaimers

### CHANGE IN SPECIFICATIONS

Product specifications and accessories may be changed at any time based on improvements and other reasons. Consult with your OMRON representative at any time to confirm actual specifications of purchased product.

### DIMENSIONS AND WEIGHTS

Dimensions and weights are nominal and are not to be used for manufacturing purposes, even when tolerances are shown.

**ALL DIMENSIONS SHOWN ARE IN MILLIMETERS.**

To convert millimeters into inches, multiply by 0.03937. To convert grams into ounces, multiply by 0.03527.

Cat. No. L101-E1-05A

## OMRON Corporation

Industrial Automation Company

### Industrial Control Components Department

Shiokoji Horikawa, Shimogyo-ku

Kyoto, 600-8530 Japan

Tel: (81)75-344-7119/Fax: (81)75-344-7149

Printed in Japan

1203 (0601)

# Mouser Electronics

Authorized Distributor

Click to View Pricing, Inventory, Delivery & Lifecycle Information:

[Omron:](#)

[Y92S-29](#)