

## LM5109 100V/1A Peak Half Bridge Gate Driver

Check for Samples: [LM5109](#)

### FEATURES

- Drives Both a High Side and Low Side N-Channel MOSFET
- 1A Peak Output Current (1.0A Sink / 1.0A Source)
- Independent TTL Compatible Inputs
- Bootstrap Supply Voltage to 118V DC
- Fast Propagation Times (27 ns Typical)
- Drives 1000 pF Load with 15ns Rise and Fall Times
- Excellent Propagation Delay Matching (2 ns Typical)
- Supply Rail Under-voltage Lockout
- Low Power Consumption
- Pin Compatible with ISL6700

### TYPICAL APPLICATIONS

- Current Fed Push-pull Converters
- Half and Full Bridge Power Converters
- Solid State Motor Drives
- Two Switch Forward Power Converters

### SIMPLIFIED BLOCK DIAGRAM

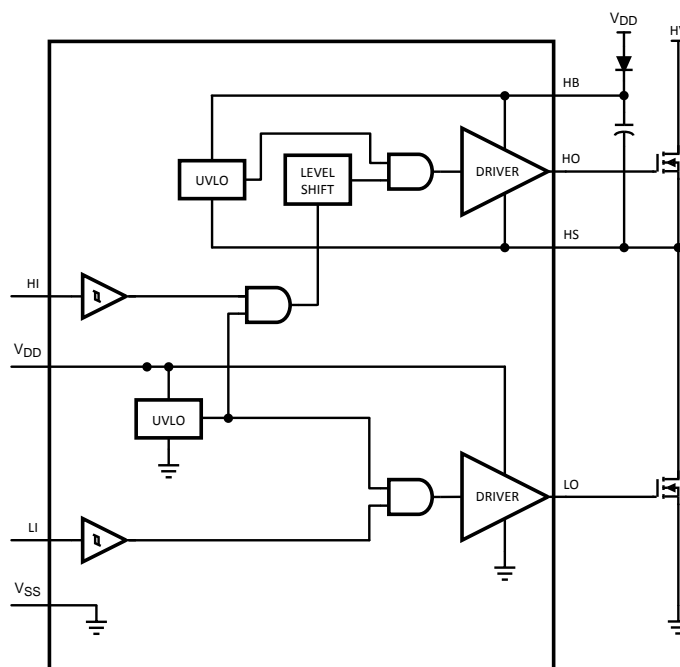

Please be aware that an important notice concerning availability, standard warranty, and use in critical applications of Texas Instruments semiconductor products and disclaimers thereto appears at the end of this data sheet.

All trademarks are the property of their respective owners.



These devices have limited built-in ESD protection. The leads should be shorted together or the device placed in conductive foam during storage or handling to prevent electrostatic damage to the MOS gates.

## CONNECTION DIAGRAMS



Figure 1.

Table 1. PIN DESCRIPTION

Pin No.		Name	Description	Application Information
SO-8	WSON-8 <sup>(1)</sup>			
1	1	V <sub>DD</sub>	Positive gate drive supply	Locally decouple to V <sub>SS</sub> using low ESR/ESL capacitor located as close to IC as possible.
2	2	HI	High side control input	The LM5109 HI input is compatible with TTL input thresholds. Unused HI input should be tied to ground and not left open
3	3	LI	Low side control input	The LM5109 LI input is compatible with TTL input thresholds. Unused LI input should be tied to ground and not left open.
4	4	V <sub>SS</sub>	Ground reference	All signals are referenced to this ground.
5	5	LO	Low side gate driver output	Connect to the gate of the low side N-MOS device.
6	6	HS	High side source connection	Connect to the negative terminal of the bootstrap capacitor and to the source of the high side N-MOS device.
7	7	HO	High side gate driver output	Connect to the gate of the low side N-MOS device.
8	8	HB	High side gate driver positive supply rail	Connect the positive terminal of the bootstrap capacitor to HB and the negative terminal of the bootstrap capacitor to HS. The bootstrap capacitor should be placed as close to IC as possible.

- (1) For WSON-8 package it is recommended that the exposed pad on the bottom of the LM5109 be soldered to ground plane on the PCB board and the ground plane should extend out from underneath the package to improve heat dissipation.

## ABSOLUTE MAXIMUM RATINGS <sup>(1)</sup>

If Military/Aerospace specified devices are required, contact the Texas Instruments Sales Office/Distributors for availability and specifications.

$V_{DD}$ to $V_{SS}$	-0.3V to 18V
HB to HS	-0.3V to 18V
LI or HI to $V_{SS}$	-0.3V to $V_{DD} + 0.3V$
LO to $V_{SS}$	-0.3V to $V_{DD} + 0.3V$
HO to $V_{SS}$	$V_{HS} - 0.3V$ to $V_{HB} + 0.3V$
HS to $V_{SS}$ <sup>(2)</sup>	-5V to 100V
HB to $V_{SS}$	118V
Junction Temperature	-40°C to +150°C
Storage Temperature Range	-55°C to +150°C
ESD Rating HBM <sup>(3)</sup>	2 kV

- (1) Absolute Maximum Ratings indicate limits beyond which damage to the component may occur. Operating Ratings are conditions under which operation of the device is specified. Operating Ratings **do not** imply specified performance limits. For specified performance limits and associated test conditions, see the Electrical Characteristics tables.
- (2) In the application the HS node is clamped by the body diode of the external lower N-MOSFET, therefore the HS voltage will generally not exceed -1V. However in some applications, board resistance and inductance may result in the HS node exceeding this stated voltage transiently. If negative transients occur on HS, the HS voltage must never be more negative than  $V_{DD} - 15V$ . For example, if  $V_{DD} = 10V$ , the negative transients at HS must not exceed -5V.
- (3) The human body model is a 100 pF capacitor discharged through a 1.5k $\Omega$  resistor into each pin. Pin 6, Pin 7 and Pin 8 are rated at 500V.

## RECOMMENDED OPERATING CONDITIONS

$V_{DD}$	8V to 14V
HS <sup>(1)</sup>	-1V to 100V
HB	$V_{HS} + 8V$ to $V_{HS} + 14V$
HS Slew Rate	< 50 V/ns
Junction Temperature	-40°C to +125°C

- (1) In the application the HS node is clamped by the body diode of the external lower N-MOSFET, therefore the HS voltage will generally not exceed -1V. However in some applications, board resistance and inductance may result in the HS node exceeding this stated voltage transiently. If negative transients occur on HS, the HS voltage must never be more negative than  $V_{DD} - 15V$ . For example, if  $V_{DD} = 10V$ , the negative transients at HS must not exceed -5V.

## ELECTRICAL CHARACTERISTICS

Specifications in standard typeface are for  $T_J = +25^\circ\text{C}$ , and those in **boldface type** apply over the full **operating junction temperature range**. Unless otherwise specified,  $V_{DD} = V_{HB} = 12V$ ,  $V_{SS} = V_{HS} = 0V$ , No Load on LO or HO.

Symbol	Parameter	Conditions	Min <sup>(1)</sup>	Typ	Max <sup>(1)</sup>	Units
<b>SUPPLY CURRENTS</b>						
$I_{DD}$	$V_{DD}$ Quiescent Current	LI = HI = 0V		0.3	<b>0.6</b>	mA
$I_{DDO}$	$V_{DD}$ Operating Current	f = 500 kHz		2.1	<b>3.4</b>	mA
$I_{HB}$	Total HB Quiescent Current	LI = HI = 0V		0.06	<b>0.2</b>	mA
$I_{HBO}$	Total HB Operating Current	f = 500 kHz		1.6	<b>3.0</b>	mA
$I_{HBS}$	HB to $V_{SS}$ Current, Quiescent	$V_{HS} = V_{HB} = 100V$		0.1	<b>10</b>	$\mu\text{A}$
$I_{HBSO}$	HB to $V_{SS}$ Current, Operating	f = 500 kHz		0.5		mA
<b>INPUT PINS LI and HI</b>						
$V_{IL}$	Low Level Input Voltage Threshold		<b>0.8</b>	1.8		V
$V_{IH}$	High Level Input Voltage Threshold			1.8	<b>2.2</b>	V
$R_I$	Input Pulldown Resistance		<b>100</b>	180	<b>500</b>	k $\Omega$
<b>UNDER VOLTAGE PROTECTION</b>						
$V_{DDR}$	$V_{DD}$ Rising Threshold	$V_{DDR} = V_{DD} - V_{SS}$	<b>6.0</b>	6.9	<b>7.4</b>	V

- (1) Min and Max limits are 100% production tested at 25°C. Limits over the operating temperature range are specified through correlation using Statistical Quality Control (SQC) methods. Limits are used to calculate Texas Instrument's Average Outgoing Quality Level (AOQL).

## ELECTRICAL CHARACTERISTICS (continued)

Specifications in standard typeface are for  $T_J = +25^\circ\text{C}$ , and those in **boldface type** apply over the full **operating junction temperature range**. Unless otherwise specified,  $V_{DD} = V_{HB} = 12\text{V}$ ,  $V_{SS} = V_{HS} = 0\text{V}$ , No Load on LO or HO.

Symbol	Parameter	Conditions	Min <sup>(1)</sup>	Typ	Max <sup>(1)</sup>	Units
$V_{DDH}$	$V_{DD}$ Threshold Hysteresis			0.5		V
$V_{HBR}$	HB Rising Threshold	$V_{HBR} = V_{HB} - V_{HS}$	<b>5.7</b>	6.6	<b>7.1</b>	V
$V_{HBH}$	HB Threshold Hysteresis			0.4		V
<b>LO GATE DRIVER</b>						
$V_{OLL}$	Low-Level Output Voltage	$I_{LO} = 100\text{ mA}$ , $V_{OHL} = V_{LO} - V_{SS}$		0.28	<b>0.45</b>	V
$V_{OHL}$	High-Level Output Voltage	$I_{LO} = -100\text{ mA}$ , $V_{OHL} = V_{DD} - V_{LO}$		0.45	<b>0.75</b>	V
$I_{OHL}$	Peak Pullup Current	$V_{LO} = 0\text{V}$		1.0		A
$I_{OLL}$	Peak Pulldown Current	$V_{LO} = 12\text{V}$		1.0		A
<b>HO GATE DRIVER</b>						
$V_{OLH}$	Low-Level Output Voltage	$I_{HO} = 100\text{ mA}$ , $V_{OLH} = V_{HO} - V_{HS}$		0.28	<b>0.45</b>	V
$V_{OHH}$	High-Level Output Voltage	$I_{HO} = -100\text{ mA}$ , $V_{OHH} = V_{HB} - V_{HO}$		0.45	<b>0.75</b>	V
$I_{OHH}$	Peak Pullup Current	$V_{HO} = 0\text{V}$		1.0		A
$I_{OLH}$	Peak Pulldown Current	$V_{HO} = 12\text{V}$		1.0		A
<b>THERMAL RESISTANCE</b>						
$\theta_{JA}$ <sup>(2)</sup>	Junction to Ambient	SOIC-8		160		°C/W
		WSO8-8 <sup>(3)</sup>		40		

(2) The  $\theta_{JA}$  is not a constant for the package and depends on the printed circuit board design and the operating conditions.

(3) 4 layer board with Cu finished thickness 1.5/1/1.5 oz. Maximum die size used. 5x body length of Cu trace on PCB top. 50 x 50mm ground and power planes embedded in PCB. See Application Note AN-1187 ([SNOA401](#)).

## SWITCHING CHARACTERISTICS

Specifications in standard typeface are for  $T_J = +25^\circ\text{C}$ , and those in **boldface type** apply over the full **operating junction temperature range**. Unless otherwise specified,  $V_{DD} = V_{HB} = 12\text{V}$ ,  $V_{SS} = V_{HS} = 0\text{V}$ , No Load on LO or HO.

Symbol	Parameter	Conditions	Min	Typ	Max	Units
<b>LM5109</b>						
$t_{LPHL}$	Lower Turn-Off Propagation Delay (LI Falling to LO Falling)			27	<b>56</b>	ns
$t_{HPHL}$	Upper Turn-Off Propagation Delay (HI Falling to HO Falling)			27	<b>56</b>	ns
$t_{LPLH}$	Lower Turn-On Propagation Delay (LI Rising to LO Rising)			29	<b>56</b>	ns
$t_{HPLH}$	Upper Turn-On Propagation Delay (HI Rising to HO Rising)			29	<b>56</b>	ns
$t_{MON}$	Delay Matching: Lower Turn-On and Upper Turn-Off			2	<b>15</b>	ns
$t_{MOFF}$	Delay Matching: Lower Turn-Off and Upper Turn-On			2	<b>15</b>	ns
$t_{RC}$ , $t_{FC}$	Either Output Rise/Fall Time	$C_L = 1000\text{ pF}$		15	-	ns
$t_{PW}$	Minimum Input Pulse Width that Changes the Output			50		ns

TYPICAL PERFORMANCE CHARACTERISTICS

V<sub>DD</sub> Operating Current vs Frequency

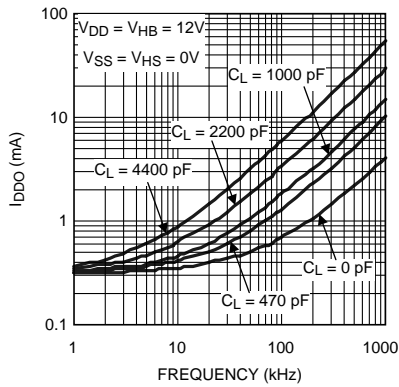

Figure 2.

HB Operating Current vs Frequency

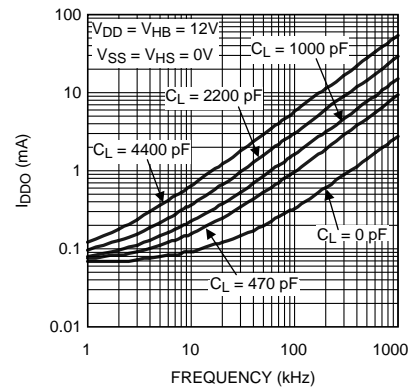

Figure 3.

Operating Current vs Temperature

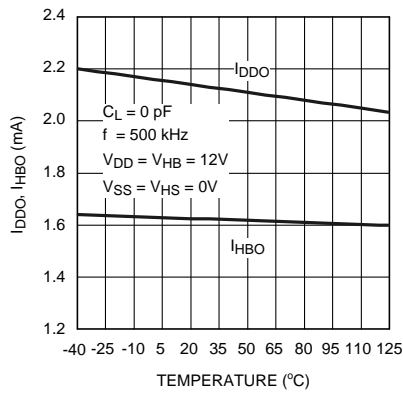

Figure 4.

Quiescent Current vs Temperature

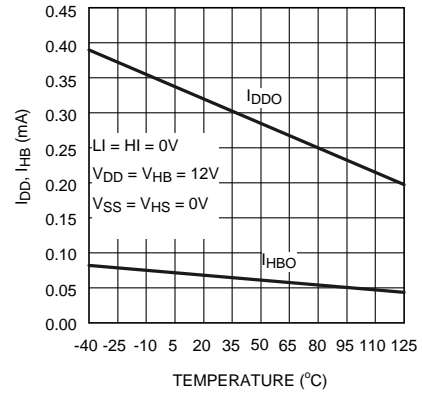

Figure 5.

Quiescent Current vs Voltage

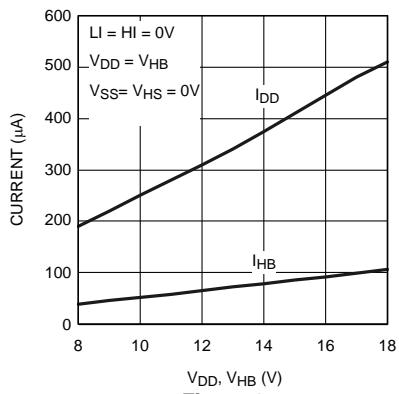

Figure 6.

Propagation Delay vs Temperature

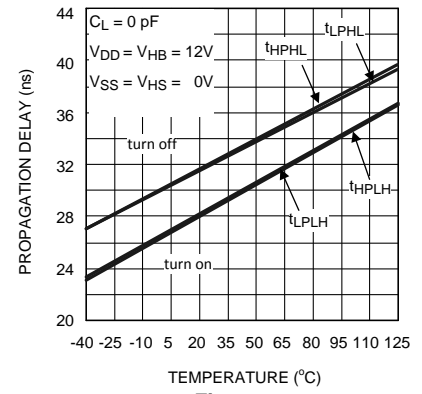
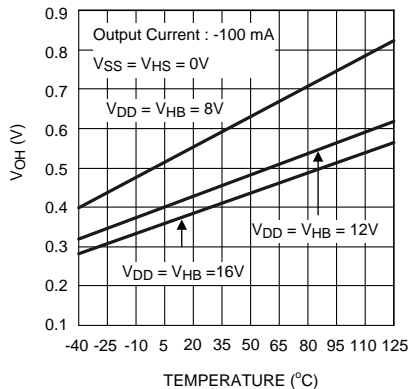

Figure 7.

**TYPICAL PERFORMANCE CHARACTERISTICS (continued)**

**LO and HO High Level Output Voltage vs Temperature**



**Figure 8.**

**LO and HO Low Level Output Voltage vs Temperature**

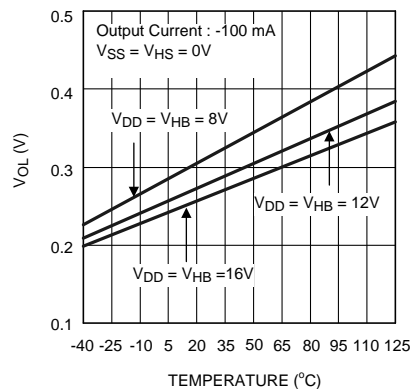

**Figure 9.**

**Undervoltage Rising Thresholds vs Temperature**

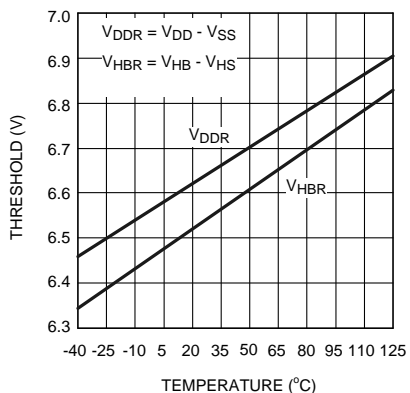

**Figure 10.**

**Undervoltage Hysteresis vs Temperature**

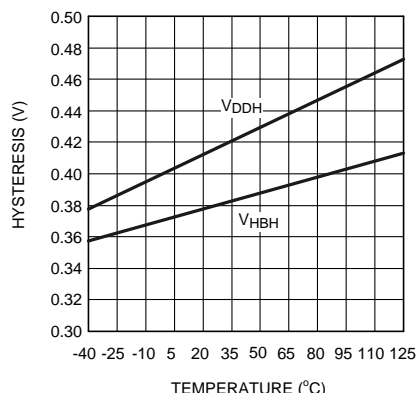

**Figure 11.**

**Input Thresholds vs Temperature**

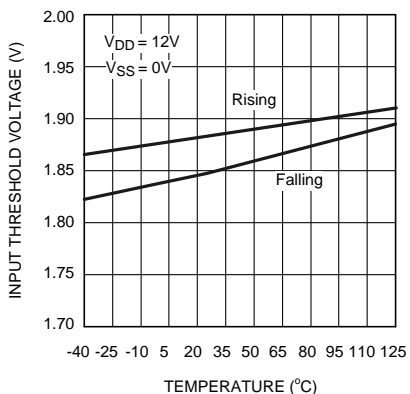

**Figure 12.**

**Input Thresholds vs Supply Voltage**

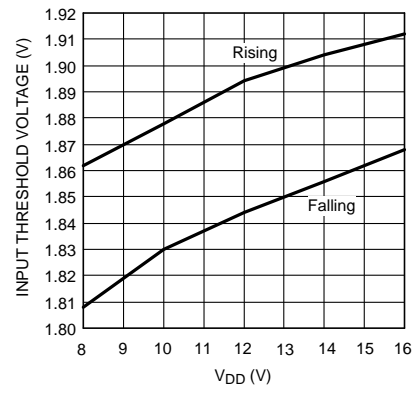

**Figure 13.**

TIMING DIAGRAM

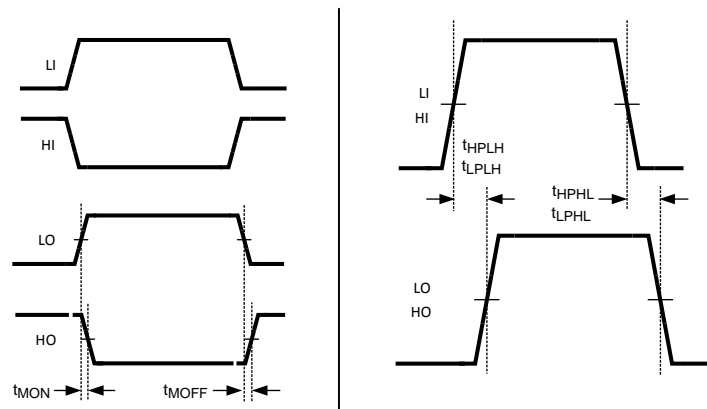

## LAYOUT CONSIDERATIONS

The optimum performance of high and low side gate drivers cannot be achieved without taking due considerations during circuit board layout. Following points are emphasized.

1. A low ESR / ESL capacitor must be connected close to the IC, and between  $V_{DD}$  and  $V_{SS}$  pins and between HB and HS pins to support high peak currents being drawn from VDD during turn-on of the external MOSFET.
2. To prevent large voltage transients at the drain of the top MOSFET, a low ESR electrolytic capacitor must be connected between MOSFET drain and ground ( $V_{SS}$ ).
3. In order to avoid large negative transients on the switch node (HS) pin, the parasitic inductances in the source of top MOSFET and in the drain of the bottom MOSFET (synchronous rectifier) must be minimized.
4. Grounding Considerations:
  - (a) The first priority in designing grounding connections is to confine the high peak currents from charging and discharging the MOSFET gate in a minimal physical area. This will decrease the loop inductance and minimize noise issues on the gate terminal of the MOSFET. The MOSFETs should be placed as close as possible to the gate driver.
  - (b) The second high current path includes the bootstrap capacitor, the bootstrap diode, the local ground referenced bypass capacitor and low side MOSFET body diode. The bootstrap capacitor is recharged on the cycle-by-cycle basis through the bootstrap diode from the ground referenced  $V_{DD}$  bypass capacitor. The recharging occurs in a short time interval and involves high peak current. Minimizing this loop length and area on the circuit board is important to ensure reliable operation.

## HS TRANSIENT VOLTAGES BELOW GROUND

The HS node will always be clamped by the body diode of the lower external FET. In some situations, board resistances and inductances can cause the HS node to transiently swing several volts below ground. The HS node can swing below ground provided:

1. HS must always be at a lower potential than HO. Pulling HO more than -0.3V below HS can activate parasitic transistors resulting in excessive current to flow from the HB supply possibly resulting in damage to the IC. The same relationship is true with LO and VSS. If necessary, a Schottky diode can be placed externally between HO and HS or LO and GND to protect the IC from this type of transient. The diode must be placed as close to the IC pins as possible in order to be effective.
2. HB to HS operating voltage should be 15V or less. Hence, if the HS pin transient voltage is -5V, VDD should be ideally limited to 10V to keep HB to HS below 15V.
3. A low ESR bypass capacitor between HB to HS as well as VDD to VSS is essential for proper operation. The capacitor should be located at the leads of the IC to minimize series inductance. The peak currents from LO and HO can be quite large. Any series inductances with the bypass capacitor will cause voltage ringing at the leads of the IC which must be avoided for reliable operation.



**PACKAGING INFORMATION**

Orderable Device	Status (1)	Package Type	Package Drawing	Pins	Package Qty	Eco Plan (2)	Lead finish/ Ball material (6)	MSL Peak Temp (3)	Op Temp (°C)	Device Marking (4/5)	Samples
LM5109MA/NOPB	LIFEBUY	SOIC	D	8	95	RoHS & Green	NIPDAU   SN	Level-1-260C-UNLIM		L5109 MA	
LM5109MAX/NOPB	LIFEBUY	SOIC	D	8	2500	RoHS & Green	NIPDAU   SN	Level-1-260C-UNLIM		L5109 MA	

(1) The marketing status values are defined as follows:

**ACTIVE:** Product device recommended for new designs.

**LIFEBUY:** TI has announced that the device will be discontinued, and a lifetime-buy period is in effect.

**NRND:** Not recommended for new designs. Device is in production to support existing customers, but TI does not recommend using this part in a new design.

**PREVIEW:** Device has been announced but is not in production. Samples may or may not be available.

**OBSOLETE:** TI has discontinued the production of the device.

(2) **RoHS:** TI defines "RoHS" to mean semiconductor products that are compliant with the current EU RoHS requirements for all 10 RoHS substances, including the requirement that RoHS substance do not exceed 0.1% by weight in homogeneous materials. Where designed to be soldered at high temperatures, "RoHS" products are suitable for use in specified lead-free processes. TI may reference these types of products as "Pb-Free".

**RoHS Exempt:** TI defines "RoHS Exempt" to mean products that contain lead but are compliant with EU RoHS pursuant to a specific EU RoHS exemption.

**Green:** TI defines "Green" to mean the content of Chlorine (Cl) and Bromine (Br) based flame retardants meet JS709B low halogen requirements of <=1000ppm threshold. Antimony trioxide based flame retardants must also meet the <=1000ppm threshold requirement.

(3) MSL, Peak Temp. - The Moisture Sensitivity Level rating according to the JEDEC industry standard classifications, and peak solder temperature.

(4) There may be additional marking, which relates to the logo, the lot trace code information, or the environmental category on the device.

(5) Multiple Device Markings will be inside parentheses. Only one Device Marking contained in parentheses and separated by a "~" will appear on a device. If a line is indented then it is a continuation of the previous line and the two combined represent the entire Device Marking for that device.

(6) Lead finish/Ball material - Orderable Devices may have multiple material finish options. Finish options are separated by a vertical ruled line. Lead finish/Ball material values may wrap to two lines if the finish value exceeds the maximum column width.

**Important Information and Disclaimer:**The information provided on this page represents TI's knowledge and belief as of the date that it is provided. TI bases its knowledge and belief on information provided by third parties, and makes no representation or warranty as to the accuracy of such information. Efforts are underway to better integrate information from third parties. TI has taken and continues to take reasonable steps to provide representative and accurate information but may not have conducted destructive testing or chemical analysis on incoming materials and chemicals. TI and TI suppliers consider certain information to be proprietary, and thus CAS numbers and other limited information may not be available for release.

In no event shall TI's liability arising out of such information exceed the total purchase price of the TI part(s) at issue in this document sold by TI to Customer on an annual basis.



**TAPE AND REEL INFORMATION**

**QUADRANT ASSIGNMENTS FOR PIN 1 ORIENTATION IN TAPE**

\*All dimensions are nominal

Device	Package Type	Package Drawing	Pins	SPQ	Reel Diameter (mm)	Reel Width W1 (mm)	A0 (mm)	B0 (mm)	K0 (mm)	P1 (mm)	W (mm)	Pin1 Quadrant
LM5109MAX/NOPB	SOIC	D	8	2500	330.0	12.4	6.5	5.4	2.0	8.0	12.0	Q1

**TAPE AND REEL BOX DIMENSIONS**

\*All dimensions are nominal

Device	Package Type	Package Drawing	Pins	SPQ	Length (mm)	Width (mm)	Height (mm)
LM5109MAX/NOPB	SOIC	D	8	2500	367.0	367.0	35.0

**TUBE**

\*All dimensions are nominal

Device	Package Name	Package Type	Pins	SPQ	L (mm)	W (mm)	T (μm)	B (mm)
LM5109MA/NOPB	D	SOIC	8	95	495	8	4064	3.05



D0008A

# PACKAGE OUTLINE

SOIC - 1.75 mm max height

SMALL OUTLINE INTEGRATED CIRCUIT



4214825/C 02/2019

NOTES:

- Linear dimensions are in inches [millimeters]. Dimensions in parenthesis are for reference only. Controlling dimensions are in inches. Dimensioning and tolerancing per ASME Y14.5M.
- This drawing is subject to change without notice.
- This dimension does not include mold flash, protrusions, or gate burrs. Mold flash, protrusions, or gate burrs shall not exceed  $.006$  [0.15] per side.
- This dimension does not include interlead flash.
- Reference JEDEC registration MS-012, variation AA.

# EXAMPLE BOARD LAYOUT

D0008A

SOIC - 1.75 mm max height

SMALL OUTLINE INTEGRATED CIRCUIT



LAND PATTERN EXAMPLE  
EXPOSED METAL SHOWN  
SCALE:8X



SOLDER MASK DETAILS

4214825/C 02/2019

NOTES: (continued)

6. Publication IPC-7351 may have alternate designs.

7. Solder mask tolerances between and around signal pads can vary based on board fabrication site.

# EXAMPLE STENCIL DESIGN

D0008A

SOIC - 1.75 mm max height

SMALL OUTLINE INTEGRATED CIRCUIT



SOLDER PASTE EXAMPLE  
BASED ON .005 INCH [0.125 MM] THICK STENCIL  
SCALE:8X

4214825/C 02/2019

NOTES: (continued)

8. Laser cutting apertures with trapezoidal walls and rounded corners may offer better paste release. IPC-7525 may have alternate design recommendations.
9. Board assembly site may have different recommendations for stencil design.



## IMPORTANT NOTICE AND DISCLAIMER

TI PROVIDES TECHNICAL AND RELIABILITY DATA (INCLUDING DATA SHEETS), DESIGN RESOURCES (INCLUDING REFERENCE DESIGNS), APPLICATION OR OTHER DESIGN ADVICE, WEB TOOLS, SAFETY INFORMATION, AND OTHER RESOURCES "AS IS" AND WITH ALL FAULTS, AND DISCLAIMS ALL WARRANTIES, EXPRESS AND IMPLIED, INCLUDING WITHOUT LIMITATION ANY IMPLIED WARRANTIES OF MERCHANTABILITY, FITNESS FOR A PARTICULAR PURPOSE OR NON-INFRINGEMENT OF THIRD PARTY INTELLECTUAL PROPERTY RIGHTS.

These resources are intended for skilled developers designing with TI products. You are solely responsible for (1) selecting the appropriate TI products for your application, (2) designing, validating and testing your application, and (3) ensuring your application meets applicable standards, and any other safety, security, regulatory or other requirements.

These resources are subject to change without notice. TI grants you permission to use these resources only for development of an application that uses the TI products described in the resource. Other reproduction and display of these resources is prohibited. No license is granted to any other TI intellectual property right or to any third party intellectual property right. TI disclaims responsibility for, and you will fully indemnify TI and its representatives against, any claims, damages, costs, losses, and liabilities arising out of your use of these resources.

TI's products are provided subject to [TI's Terms of Sale](#) or other applicable terms available either on [ti.com](https://www.ti.com) or provided in conjunction with such TI products. TI's provision of these resources does not expand or otherwise alter TI's applicable warranties or warranty disclaimers for TI products.

TI objects to and rejects any additional or different terms you may have proposed.

Mailing Address: Texas Instruments, Post Office Box 655303, Dallas, Texas 75265  
Copyright © 2024, Texas Instruments Incorporated