

# Q8 series

Ø8 mm panel mount LED indicators



## DISTINCTIVE FEATURES

5mm colored diffused epoxy lens or 5 mm water clear super bright LEDs

Prominent, recessed and flush bezel styles

(2.8 x 0.8) solder lug/faston terminals, pins or (200 mm long) wire terminations (2.0 x 0.5) solder lug/faston terminals on tri-color versions



## ENVIRONMENTAL SPECIFICATIONS

- IP67 sealing option (EN60529)
- Operating & Storage Temperature Range:  
Rear plastic body: -30 °C to +65 °C (-22 °F to +149 °F)  
Rear epoxy body: -40 °C to +85 °C (-40 °F to +185 °F)



## GENERAL SPECIFICATIONS

- Max Reverse Voltage: 5 V
- Viewing Angle: 30–100° (dependant on model)
- Life Expectancy: 100,000 hours
- Torque: 20 to 25 cNm
- Maximum panel thickness 7 mm



## MATERIALS

- Plated brass bezel finished in bright chrome, black or satin grey and moulded polycarbonate rear body



## MOUNTING

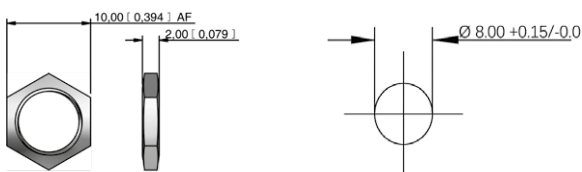

The company reserves the right to change specifications without notice.

All LED characteristics are dependent upon environmental conditions. Therefore published data should be considered nominal and subject to variations.



# Q8 series

Ø8 mm panel mount LED indicators



## ELECTRICAL SPECIFICATIONS

### STANDARD LED INTENSITY

LED COMPONENT SPECIFICATIONS			
	Prominent and Recessed	Flush	Forward Voltage
HE Red	80 mcd	8 mcd	2.0 V
Green	60 mcd	6 mcd	2.2 V
Yellow	50 mcd	6 mcd	2.1 V
Blue	1,600 mcd	50 mcd	3.3 V
White	1,600 mcd	500 mcd	3.3 V
Orange	60 mcd	110 mcd	2.2 V
Bi-color (Typical) (Red/Green)	14/30 mcd	15/10 mcd	2.0V/2.2 V
Tri-color (Typical) (Red/Green/Yellow)	60/15/13 mcd	15/10/6 mcd	2.0 V/2.2 V/2.1 V

Bi-color - The color is changed by reversing the polarity of the supply voltage.  
Tri-color - The indicator has red and green LEDs, when both connected yellow is produced.

### SUPER BRIGHT LED INTENSITY

LED COMPONENT SPECIFICATIONS			
	Prominent and Recessed	Flush	Forward Voltage
HE Red	5,000 mcd	1,300 mcd	2.2 V
Green	10,000 mcd	1,200 mcd	3.3 V
Yellow	4,000 mcd	350 mcd	2.0 V
Blue	2,200 mcd	280 mcd	3.3 V
White	2,500 mcd	950 mcd	3.3 V
Orange	4,000 mcd	500 mcd	2.2 V

### HYPER BRIGHT LED INTENSITY

LED COMPONENT SPECIFICATIONS			
	Prominent and Recessed	Flush	Forward Voltage
HE Red	6,000 mcd	980 mcd	2.2 V
Green	1,900 mcd	300 mcd	3.3 V
Yellow	1,600 mcd	250 mcd	2.0 V
Orange	2,400 mcd	110 mcd	2.2 V









- The operating voltage must not be exceeded by more than 10% as this will result in reduced life expectancy
- Luminous intensity is measured at 20 mA on a discrete led unless otherwise stated.
- Luminous intensities and color shades of white LEDs may vary within a batch.
- Luminous intensity will be reduced with lower operating current.

Voltage	Operating Voltage	Operating Current
	(Min to Max)	(Typical All Types)
02 (No Resistor)*	1.8 to 3.3 VDC	20 mA max
6 VDC	5.4 to 6.6 VDC	20 mA
12 VDC	10.8 to 13.2 VDC	20 mA
24 VDC	21.6 to 26.4 VDC	20 mA
28 VDC	25.2 to 30.8 VDC	20 mA
110 VAC	99 to 121 VAC	6 mA
220 VAC	207 to 235 VAC	3 mA

\* Customer to supply resistor for desired operating current.



### BUILD YOUR PART NUMBER

 <b>Q</b> SERIES	 <b>8</b> Ø8 mm MOUNTING HOLE	 <b>P</b> Prominent <b>R</b> Recessed <b>F</b> Flush BEZEL STYLE	 <b>1</b> Solder Lug/ Fastons (2.8 x 0.8) <b>2</b> Pins <b>3</b> Wires <b>4</b> Rear epoxy Pins <b>5</b> Rear epoxy Wires <b>6</b> Short body Pins <b>7</b> Short body Wires <b>8</b> Short body Lug/ Fastons (2.8 x 0.8) <b>9</b> Extended short body solder Lug/ Fastons (2.8 x 0.5) TERMINALS	 <b>C</b> Bright Chrome <b>B</b> Black <b>G</b> Satin Grey BEZEL FINISH
 <b>XX</b> Fixed Light <b>KK</b> Flashing Light (12V – 28VDC) <b>YY</b> Bi-color <b>ZZ</b> Tri-color TYPE OF ILLUMINATION	 <b>R</b> Red <b>G</b> Green <b>Y</b> Yellow <b>B</b> Blue <b>W</b> White <b>O</b> Orange <b>HR</b> Hyper Bright Red <b>HG</b> Hyper Bright Green <b>HY</b> Hyper Bright Yellow <b>HO</b> Hyper Bright Orange <b>SR</b> Super Bright Red <b>SG</b> Super Bright Green <b>SY</b> Super Bright Yellow <b>SB</b> Super Bright Blue LED COLOR	 <b>SW</b> Super Bright White <b>SO</b> Super Bright Orange <b>RG</b> Red/Green <b>RY</b> Red/Yellow <b>GY</b> Green/Yellow <b>RYG</b> Red/Yellow/Green VOLTAGE	 <b>02</b> no resistor* <b>06</b> 6 VDC <b>12</b> 12 VDC <b>12A</b> 12 VAC/DC <b>24</b> 24 VDC <b>24A</b> 24 VAC/DC <b>28</b> 28 VDC <b>28A</b> 28 VAC/DC <b>110</b> 110 VAC <b>220</b> 220 VAC <b>(Blank)</b> Unsealed <b>E</b> IP67 SEALING	



### ABOUT THIS SERIES

- Notice:** please note that not all combinations of above numbers are available.
- Gold faston terminal denotes anode (+), silver terminal denotes cathode (-)
  - Standard wire length is 200 mm, 24 AWG UL1061, red wire denotes anode (+), black wire denotes cathode (-) for other wire lengths consult APEM
  - 110 VAC and 220 VAC, only available with terminal options 1 & 3
  - Bi-color leds, by connecting the gold faston (+) one color is produced, by reversing the supply voltage another color is produced – bi-colors are available up to 28 VDC [AC products not available]
  - Take care when soldering to the faston terminals (recommended solder temperature 300 °C - 3 sec)
  - Terminal options 2,6,7 & 9 are only available up to 28 V (DC only). Tri-color not available with terminal 9
  - Terminal code 8 is only available without integral resistor, see forward voltage values.
  - We recommend using hyperbright or superbright leds for use at 110 VAC and 220 VAC
  - Mains voltage product is not recommended for use on 3 phase appliances
  - The tri-color led has red and green leds when both are connected yellow is produced
  - Standard tri-color faston terminals are two anodes (+) and one cathode (-)
  - Tri-color wires are one red (+) and one green (+) anode and one black (-) cathode
  - Tri-color pins are center (-) cathode, shortest (+) anode pin green, longest (+) anode pin red

# Q8 series

Ø8 mm panel mount LED indicators

## PROMINENT BEZEL



### WIRES

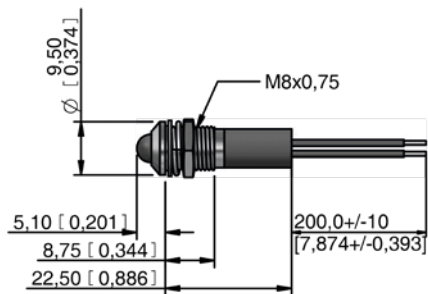

### REAR EPOXY WIRES

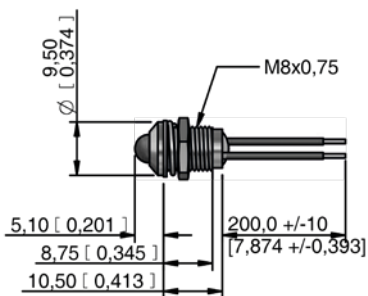

### SHORT BODY WIRES

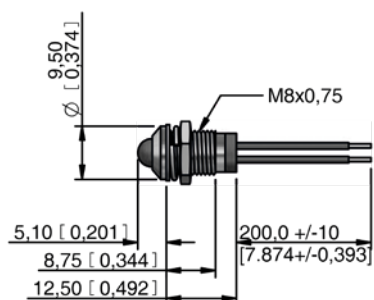

## SOLDER LUG/FASTON

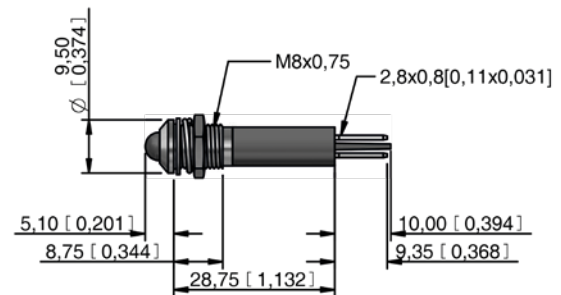

### PINS

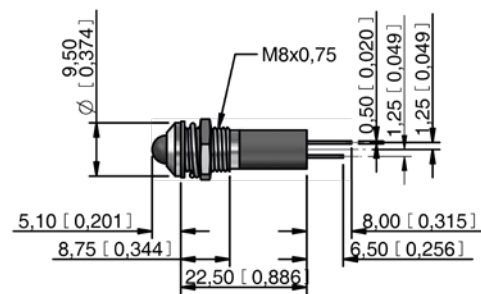

### REAR EPOXY PINS

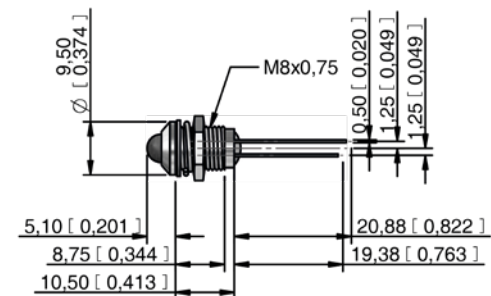

### SHORT BODY PINS

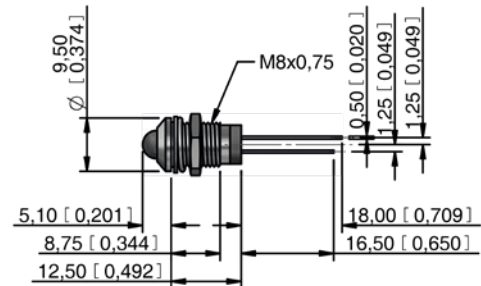

### PROMINENT BEZEL (CONTINUED) SHORT BODY SOLDER LUG/FASTONS

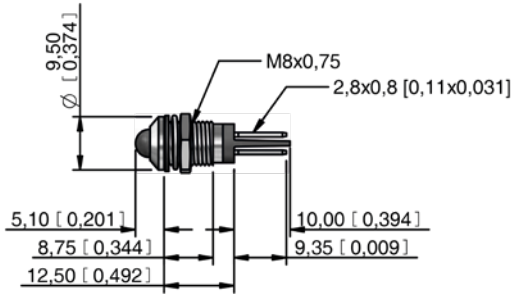

### EXTENDED SHORT BODY SOLDER LUG/FASTONS

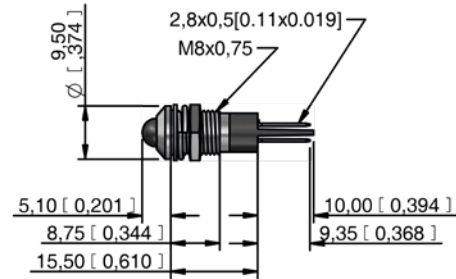

### FLUSH BEZEL



### SOLDER LUG/FASTON

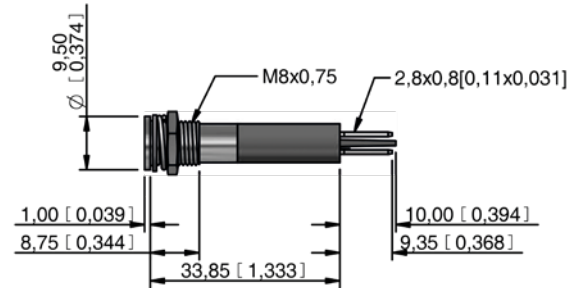

### WIRES

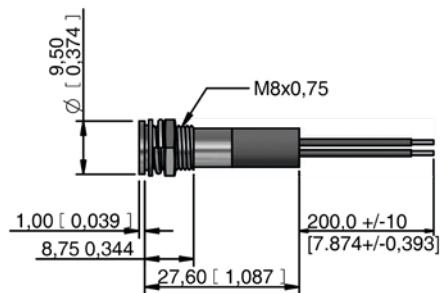

### PINS

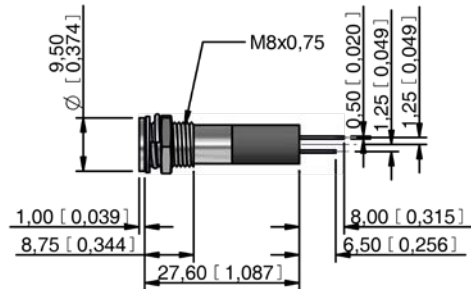

### REAR EPOXY WIRES

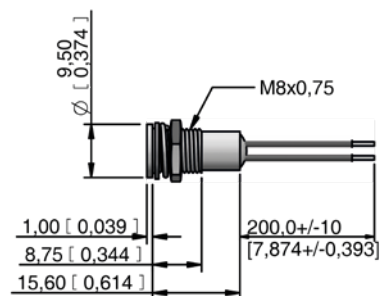

### REAR EPOXY PINS

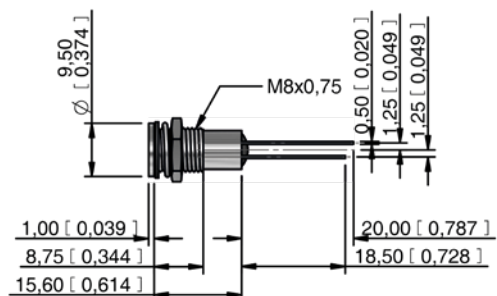

# Q8 series

Ø8 mm panel mount LED indicators

## FLUSH BEZEL (CONTINUED)

SHORT BODY WIRES

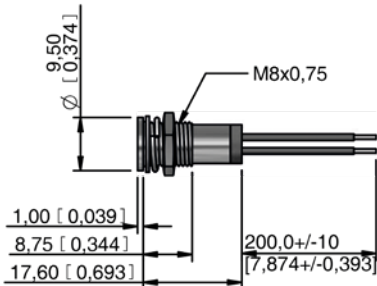

SHORT BODY PINS

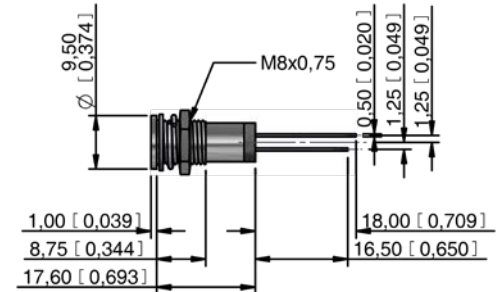

SHORT BODY SOLDER LUG/FASTONS

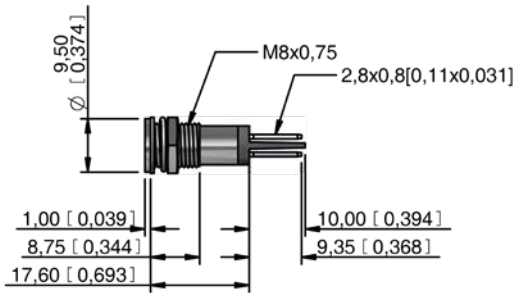

EXTENDED SHORT BODY SOLDER LUG/FASTONS

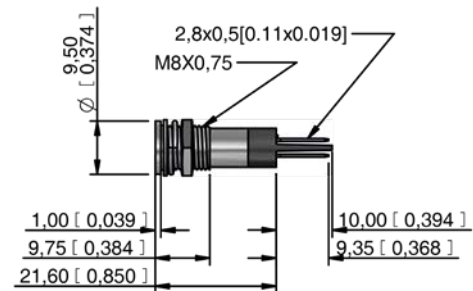

## RECESSED BEZEL



SOLDER LUG/FASTON

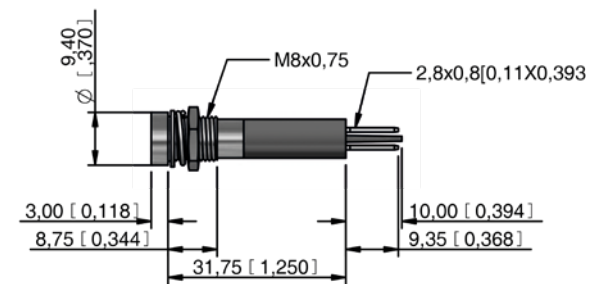

WIRES

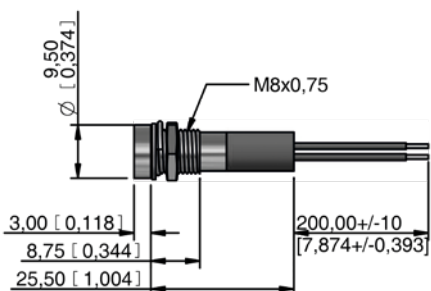

PINS

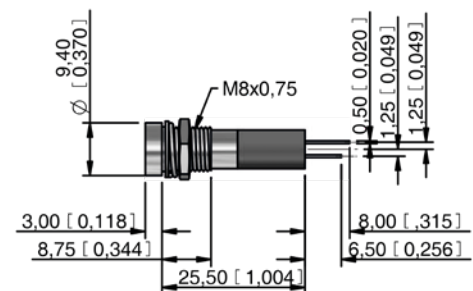

### RECESSED BEZEL (CONTINUED)

#### REAR EPOXY WIRES

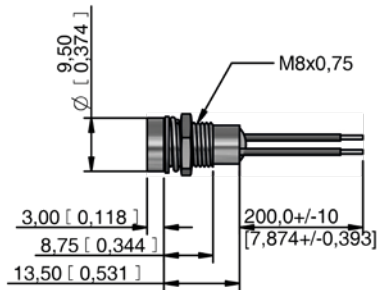

#### REAR EPOXY PINS

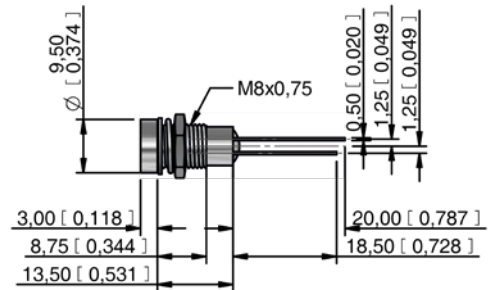

#### SHORT BODY WIRES

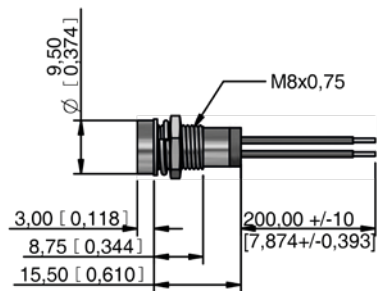

#### SHORT BODY PINS

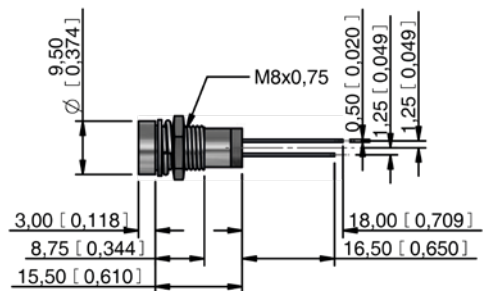

#### SHORT BODY SOLDER LUG/FASTONS

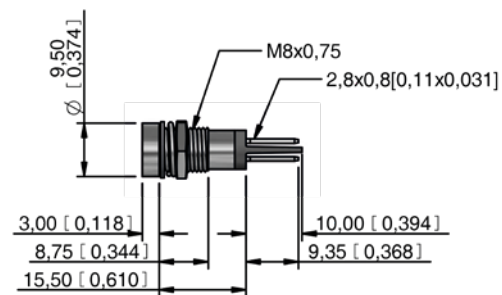

#### EXTENDED SHORT BODY SOLDER LUG/FASTONS

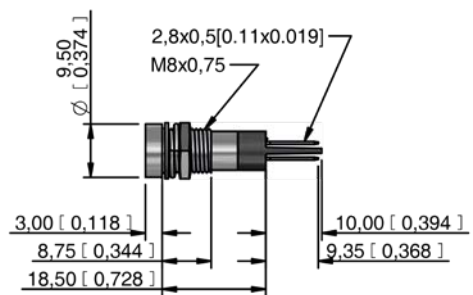

# Mouser Electronics

Authorized Distributor

Click to View Pricing, Inventory, Delivery & Lifecycle Information:

## Apem:

[Q8F1BXXB110E](#) [Q8F1BXXB12E](#) [Q8F1BXXB24E](#) [Q8F1BXXG110E](#) [Q8F1BXXG12E](#) [Q8F1BXXG24E](#)  
[Q8F1BXXR110E](#) [Q8F1BXXR12E](#) [Q8F1BXXR24E](#) [Q8F1BXXW110E](#) [Q8F1BXXW12E](#) [Q8F1BXXW24E](#)  
[Q8F1BXXY110E](#) [Q8F1BXXY12E](#) [Q8F1BXXY24E](#) [Q8F7BXXR02E](#) [Q8P3BXXG02](#) [Q8P3BXXG24](#) [Q8P3BXXR24](#)  
[Q8P7BXXR12E-SP](#) [Q8P1CXXSR110](#) [Q8P1CXXSG110](#) [311 Q8F8BXXSG02E](#) [Q8P3BXXY12E](#) [Q8F7BXXG24E](#)  
[Q8F3BXXR24E](#) [Q8P7BXXG02E](#) [Q8P3BXXG12E](#) [Q8F3BXXG12E](#) [Q8F3CXXB12E](#) [Q8F7BXXG02E](#)  
[Q8F3BZZRYG12E](#) [Q8F3CXXR24E](#) [Q8F3BXXB24E](#) [Q8F3CXXG12E](#) [Q8F3CXXR12E](#) [Q8F3CXXW24E](#)  
[Q8F3CXXG24E](#) [Q8F3BXXR12E](#) [Q8P3BXXY24E](#) [Q8F1BXXG02E](#) [Q8P7CZZRYG02E](#) [Q8F1BZZRYG12E](#)  
[Q8F1BXXB24EX0238](#) [Q8F3BXXG02E](#) [Q8P7CXXSB12E](#) [Q8F1BXXSG110E](#) [Q8F1BXXY02E](#) [Q8F1BXXR02E](#)  
[Q8F3BXXSY220E](#) [Q8P6BYYRG28E](#) [Q8P1BXXG28E](#) [Q8P1BXXY28E](#) [Q8P1BXXR28E](#) [Q8F3BXXW24E](#)  
[Q8F1BXXR28](#) [Q8R5BZZRYG02E](#) [Q8R5GZZRYG02E](#) [Q8F1BXXR28E](#) [Q8F3BXXR24AE](#) [Q8F3BXXG24AE](#)  
[Q8F3BXXSG220E](#) [Q8F3BXXG24](#)