



MCH6321

P-Channel Power MOSFET -20V, -4A, 83mΩ, Single MCPH6

ON Semiconductor®

<http://onsemi.com>

Features

- 1.8V drive
- Protection diode in

Specifications

Absolute Maximum Ratings at Ta=25°C

Parameter	Symbol	Conditions	Ratings	Unit
Drain-to-Source Voltage	V _{DSS}		-20	V
Gate-to-Source Voltage	V _{GSS}		±10	V
Drain Current (DC)	I _D		-4	A
Drain Current (Pulse)	I _{DP}	PW≤10μs, duty cycle≤1%	-16	A
Allowable Power Dissipation	P _D	When mounted on ceramic substrate (1200mm ² ×0.8mm)	1.5	W
Channel Temperature	T _{ch}		150	°C
Storage Temperature	T _{stg}		-55 to +150	°C

Stresses exceeding those listed in the Maximum Ratings table may damage the device. If any of these limits are exceeded, device functionality should not be assumed, damage may occur and reliability may be affected.

Package Dimensions

unit : mm (typ)

7022A-009

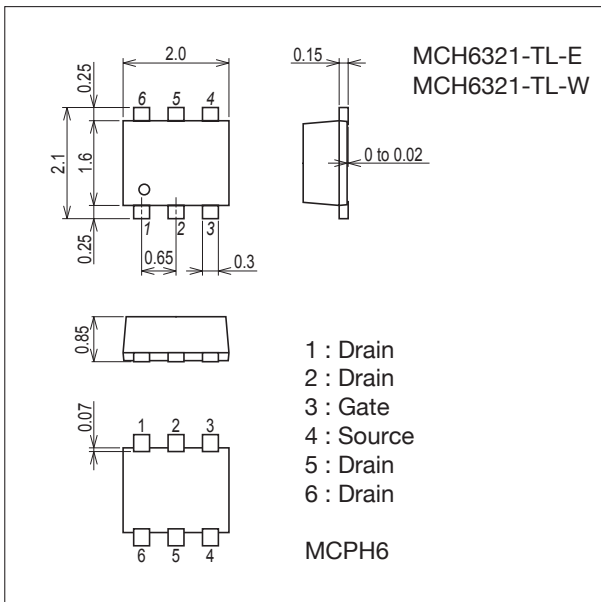

Product & Package Information

- Package : MCPH6
- JEITA, JEDEC : SC-88, SC-70-6, SOT-363
- Minimum Packing Quantity : 3,000 pcs./reel

Packing Type : TL

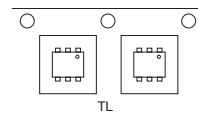

Marking

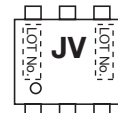

Electrical Connection

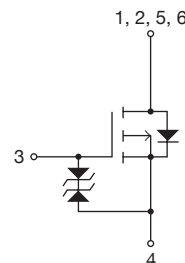

ORDERING INFORMATION

See detailed ordering and shipping information on page 2 of this data sheet.

MCH6321

Electrical Characteristics at Ta=25°C

Parameter	Symbol	Conditions	Ratings			Unit
			min	typ	max	
Drain-to-Source Breakdown Voltage	$V_{(BR)DSS}$	$I_D = -1mA, V_{GS} = 0V$	-20			V
Zero-Gate Voltage Drain Current	I_{DSS}	$V_{DS} = -20V, V_{GS} = 0V$			-1	μA
Gate-to-Source Leakage Current	I_{GSS}	$V_{GS} = \pm 8V, V_{DS} = 0V$			± 10	μA
Cutoff Voltage	$V_{GS(off)}$	$V_{DS} = -10V, I_D = -1mA$	-0.4		-1.3	V
Forward Transfer Admittance	$ y_{fs} $	$V_{DS} = -10V, I_D = -2A$	2.5	4.3		S
Static Drain-to-Source On-State Resistance	$R_{DS(on)1}$	$I_D = -2A, V_{GS} = -4.5V$		63	83	$m\Omega$
	$R_{DS(on)2}$	$I_D = -1A, V_{GS} = -2.5V$		88	125	$m\Omega$
	$R_{DS(on)3}$	$I_D = -0.2A, V_{GS} = -1.8V$		130	200	$m\Omega$
Input Capacitance	C_{iss}			375		pF
Output Capacitance	C_{oss}	$V_{DS} = -10V, f = 1MHz$		77		pF
Reverse Transfer Capacitance	C_{rss}			58		pF
Turn-ON Delay Time	$t_{d(on)}$	See specified Test Circuit.		8.1		ns
Rise Time	t_r			31		ns
Turn-OFF Delay Time	$t_{d(off)}$			40		ns
Fall Time	t_f			39		ns
Total Gate Charge	Q_g				4.6	
Gate-to-Source Charge	Q_{gs}	$V_{DS} = -10V, V_{GS} = -4.5V, I_D = -4A$		0.8		nC
Gate-to-Drain "Miller" Charge	Q_{gd}			1.3		nC
Diode Forward Voltage	V_{SD}	$I_S = -4A, V_{GS} = 0V$		-0.86	-1.2	V

Product parametric performance is indicated in the Electrical Characteristics for the listed test conditions, unless otherwise noted. Product performance may not be indicated by the Electrical Characteristics if operated under different conditions.

Switching Time Test Circuit

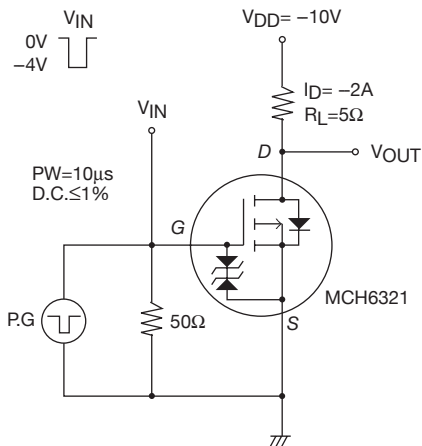

Ordering Information

Device	Package	Shipping	memo
MCH6321-TL-E	MCPH6	3,000pcs./reel	Pb-Free
MCH6321-TL-W			Pb-Free and Halogen Free

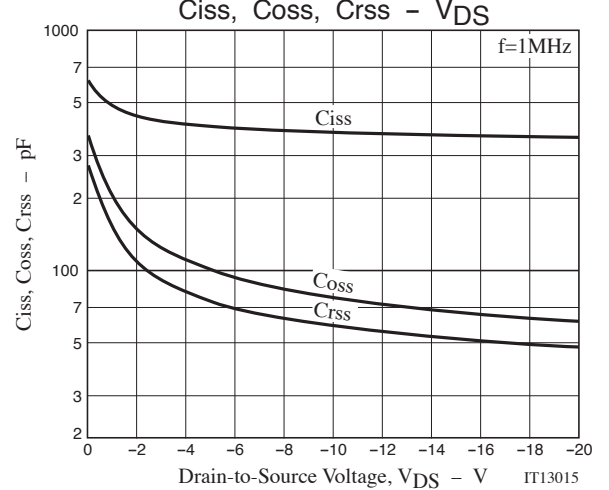
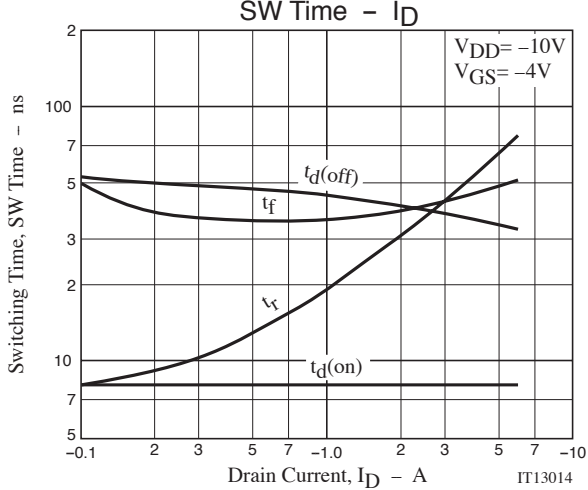
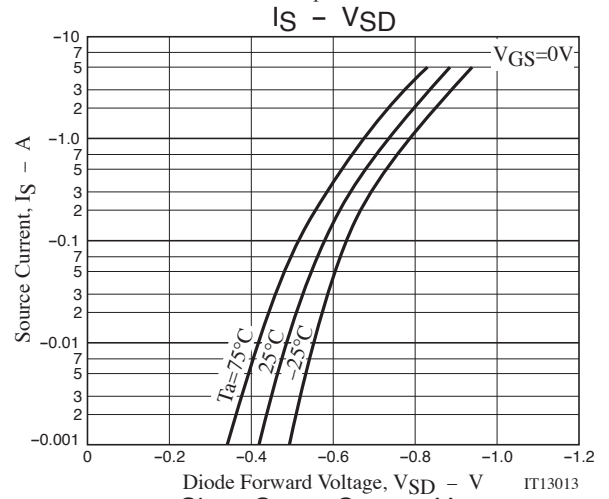
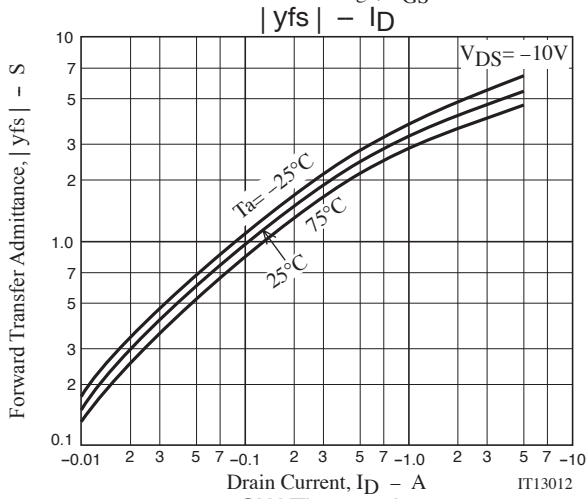
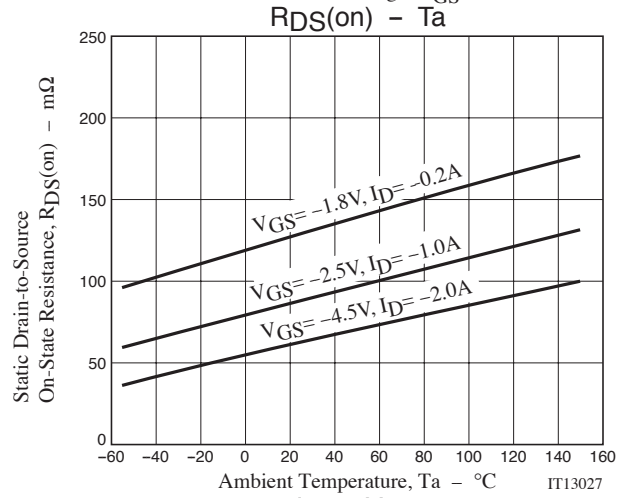
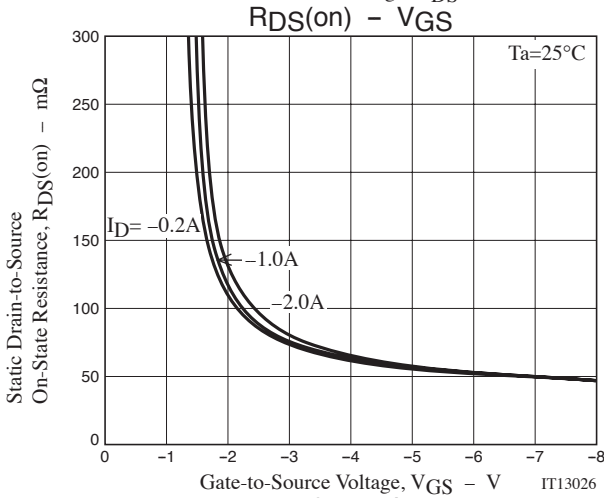
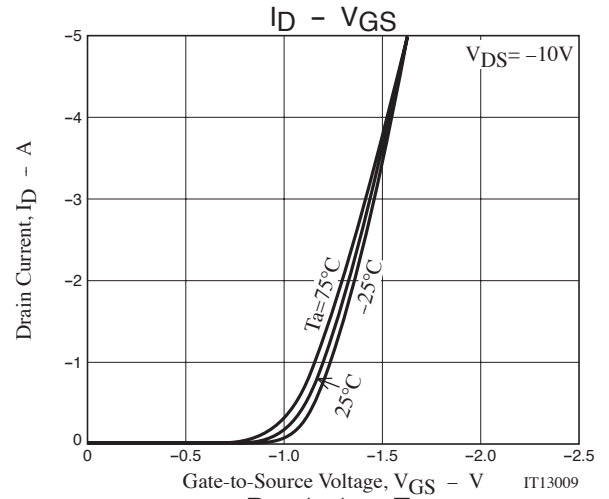
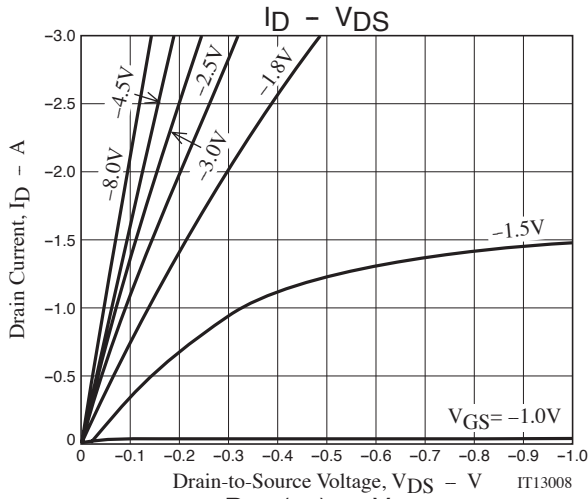

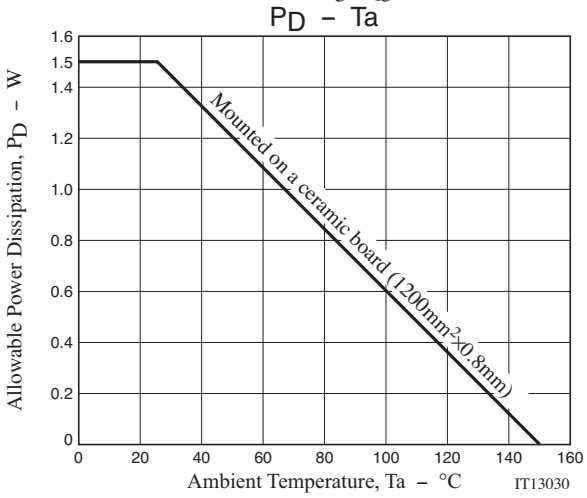
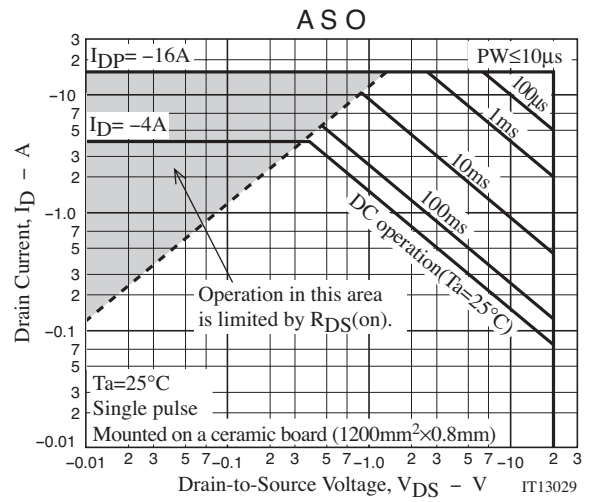
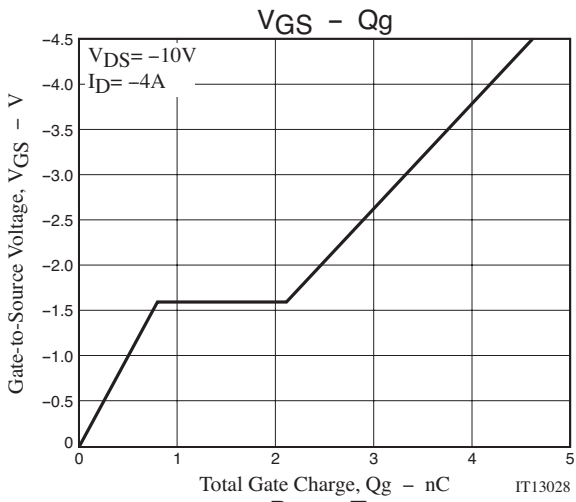

Mouser Electronics

Authorized Distributor

Click to View Pricing, Inventory, Delivery & Lifecycle Information:

[ON Semiconductor:](#)

[MCH6321-TL-E](#)