

SMT POWER INDUCTORS

Planar - PA1X9XNL Series

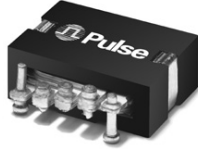

- Height:** 7.4mm Max
- Footprint:** 19.8mm x 19.6mm Max
- Current Rating:** up to 73A
- Inductance Range:** .405μH to 6.2μH

Electrical Specifications @ 25°C — Operating Temperature -40°C to +130°C⁸

Part Number ^{5,7}	Inductance @ Irated (μH ±15%)	Irated ¹ (ADC)	DCR (mΩ)		Inductance @ 0 A _{dc} (μH ±15%)	Saturation Current ²		Heating Current ³ (A)
			TYP	MAX		25°C	100°C	
2-TURN (LOW - LOSS) SERIES								
PA1294.450NL	0.45	73	.38	.48	0.45	95	80	73
PA1294.650NL	0.63	54	.38	.48	0.65	63	53	73
PA1294.910NL	0.85	39	.38	.48	0.91	46	37	73
PA1294.112NL	1.05	30	.38	.48	1.10	35	30	73
PA1294.132NL	1.25	25	.38	.48	1.30	29	26	73
PA1294.152NL	1.45	21	.38	.48	1.50	24	22	73
2-TURN SERIES								
PA1292.450NL	0.45	52	.78	.98	0.45	95	80	52
PA1292.650NL	0.63	52	.78	.98	0.65	63	53	52
PA1292.910NL	0.85	39	.78	.98	0.91	46	37	52
PA1292.112NL	1.05	30	.78	.98	1.10	35	30	52
PA1292.132NL	1.25	25	.78	.98	1.30	29	26	52
PA1292.152NL	1.45	21	.78	.98	1.50	24	22	52
3-TURN SERIES								
PA1393.102NL	0.95	42	1.15	1.43	1.0	68	54	42
PA1393.152NL	1.40	36	1.15	1.43	1.5	43	35	42
PA1393.202NL	1.90	25	1.15	1.43	2.0	29	25	42
PA1393.252NL	2.40	20	1.15	1.43	2.5	23	21	42
PA1393.302NL	2.80	15	1.15	1.43	3.0	18	16	42
PA1393.352NL	3.40	12	1.15	1.43	3.5	15	13	42
4-TURN SERIES								
PA1494.162NL	1.60	37	1.44	1.80	1.60	55	43	37
PA1494.242NL	2.40	30	1.44	1.80	2.42	35	27	37
PA1494.362NL	3.30	17	1.44	1.80	3.60	20	18	37
PA1494.442NL	4.00	14	1.44	1.80	4.40	16	15	37
PA1494.532NL	4.90	11	1.44	1.80	5.34	13	12	37
PA1494.622NL	5.80	9	1.44	1.80	6.20	11	10	37

NOTES:

- The rated current as listed is either 85% of the saturation current or the heating current, depending on which value is lower.
- The saturation current is the current which causes the inductance to drop by 15% at the stated ambient temperatures (25°C and 100°C). This current is determined by placing the component in the specified ambient environment and applying a short duration pulse current (to eliminate self-heating effects) to the component.
- The heating current is the DC current which causes the temperature of the part to increase by approximately 45°C. This current is determined by mounting the component on a PCB with .25" wide, 2 oz. equivalent copper traces, and applying the current to the device for 30 minutes with no forced air cooling.
- In high volt*time applications, additional heating in the component can occur due to core losses in the inductor which may necessitate derating the current in order to limit the temperature rise of the component. In order to determine the approximate total losses (or temperature rise) for a given application, the total copper and core losses should be taken into account. For approximate value of core losses, in a given application, use the core loss graph on page 24.
- Optional Tape & Reel packaging can be ordered by adding a "T" suffix to the part number (i.e. PA1294.450NL becomes PA1294.450NLT). Pulse complies to industry standard tape and reel specification EIA481.
- Meets solderability test per IPC/EIA J-STD-002B using flux type ORL0.
- The "NL" suffix indicates an RoHS-compliant part number. Non-NL suffixed parts are not necessarily RoHS compliant, but are electrically and mechanically equivalent to NL versions. If a part number does not have the "NL" suffix, but an RoHS compliant version is required, please contact Pulse for availability.
- The temperature of the component (ambient plus temperature rise) must be within the stated operating temperature range.

USA 858 674 8100 • Germany 49 7032 7806 0 • Singapore 65 6287 8998 • Shanghai 86 21 54643211 / 2 • China 86 755 33966678 • Taiwan 886 3 4641811

SMT POWER INDUCTORS

Planar - PA1X9XNL Series



Mechanical

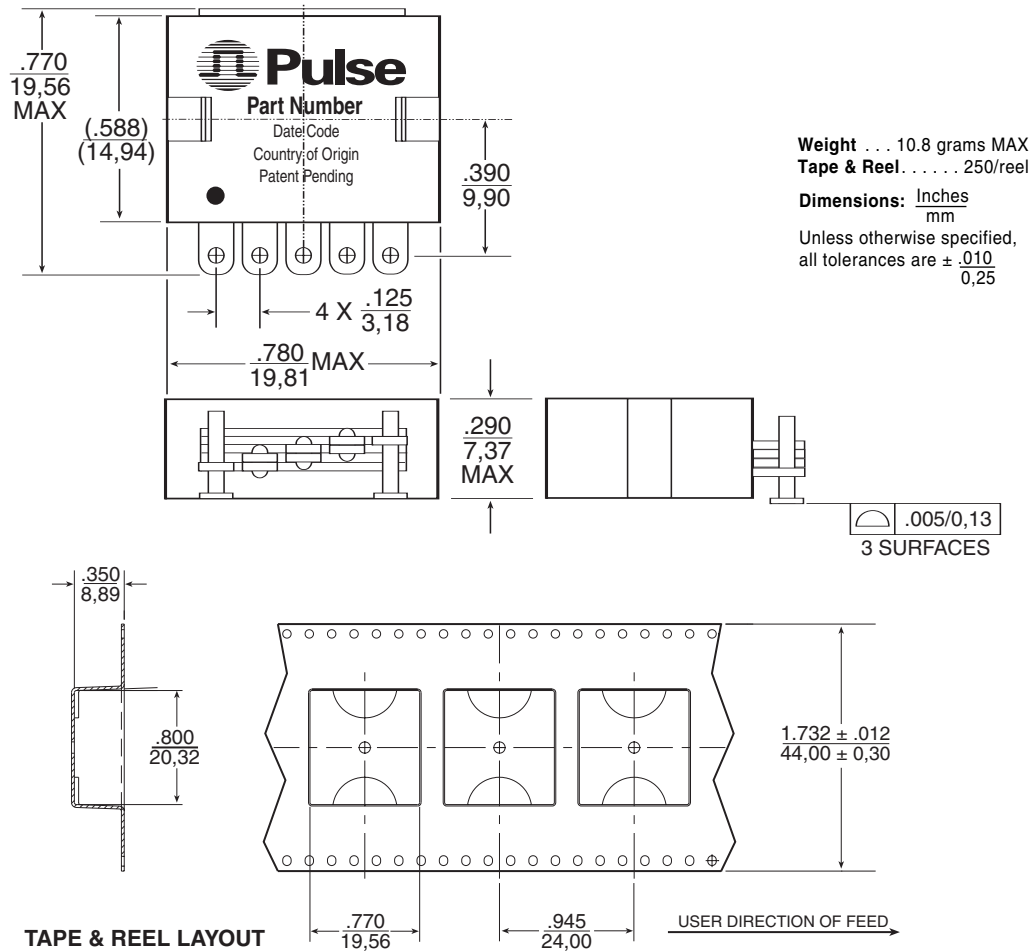

Suggested Pad Layouts and Schematics

PA1292 & PA1294
 .405 to 1.50 μH
 21 to 73 Adc

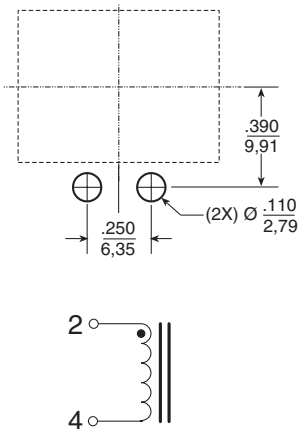

PA1393
 1.00 to 3.40 μH
 12 to 42 Adc

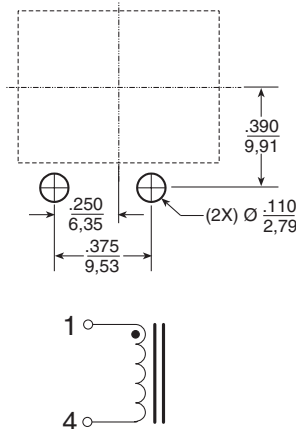

PA1494
 1.60 to 6.20 μH
 9 to 37 Adc

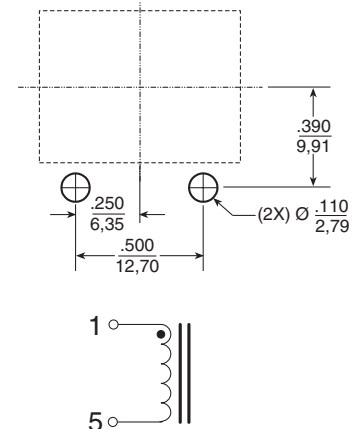

Inductance vs. Current Characteristics (25°C)

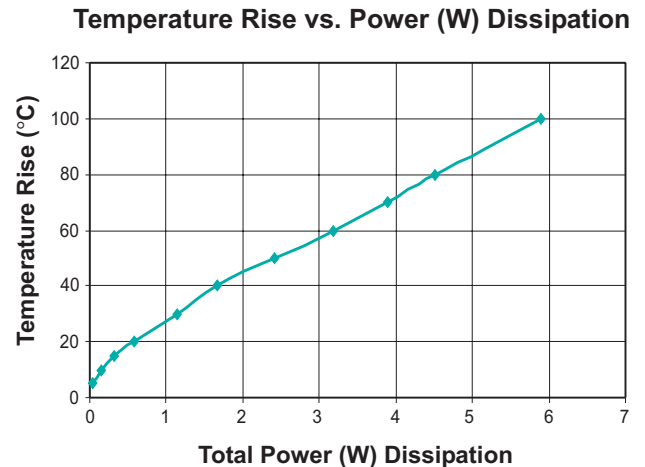
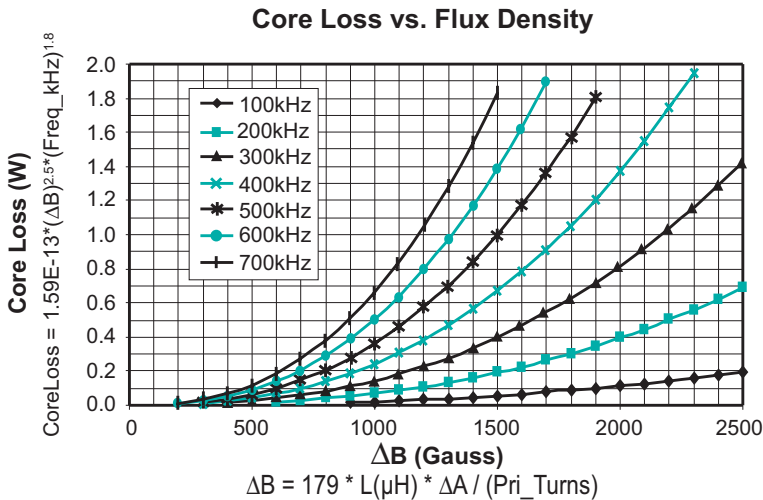
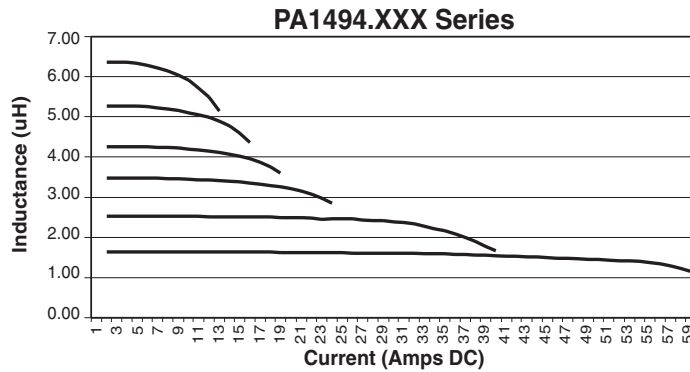
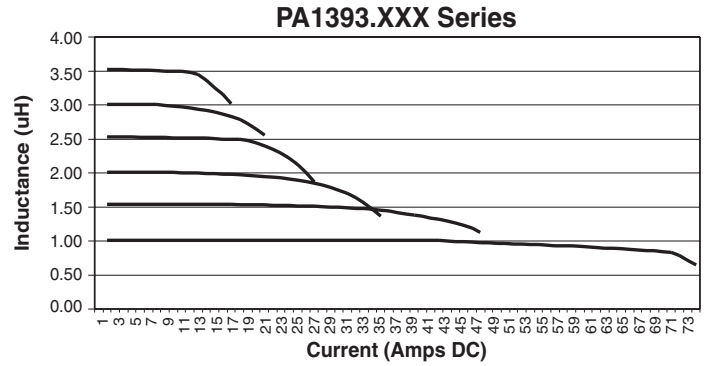
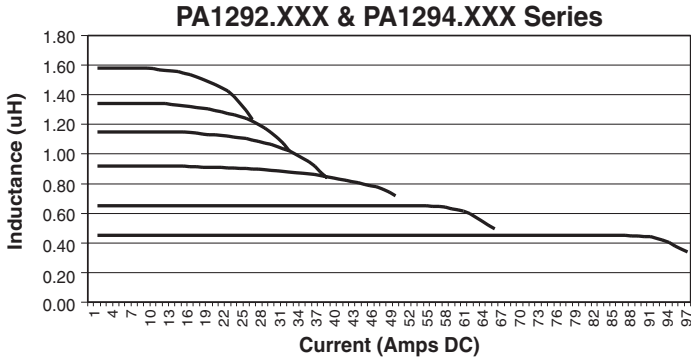

Total Power Dissipation = Copper Loss (W) + Core Loss (W)

Copper Loss (W) = $Current(rms)^2 * DCR(m\Omega) / 1000$
 Core Loss (W) = per table

Mouser Electronics

Authorized Distributor

Click to View Pricing, Inventory, Delivery & Lifecycle Information:

Pulse:

[PA1292.112](#) [PA1292.132](#) [PA1292.152](#) [PA1292.450](#) [PA1292.650](#) [PA1292.910](#) [PA1294.112](#) [PA1294.132](#)
[PA1294.152](#) [PA1294.152T](#) [PA1294.450](#) [PA1294.450T](#) [PA1294.650](#) [PA1294.910](#) [PA1294.910T](#) [PA1393.102](#)
[PA1393.152](#) [PA1393.202](#) [PA1393.252](#) [PA1393.302](#) [PA1393.352](#) [PA1494.162](#) [PA1494.242](#) [PA1494.242T](#)
[PA1494.362](#) [PA1494.442](#) [PA1494.442T](#) [PA1494.622](#) [PA1294.112NLT](#) [PA1294.152NLT](#) [PA1294.450NLT](#)
[PA1494.532NL](#) [PA1393.202NL](#) [PA1292.910NLT](#) [PA1494.362NL](#) [PA1292.450NLT](#) [PA1292.112NL](#) [PA1494.162NL](#)
[PA1494.242NL](#) [PA1494.622NL](#) [PA1494.362NLT](#) [PA1494.442NL](#) [PA1393.152NL](#) [PA1292.152NL](#) [PA1494.622NLT](#)
[PA1393.302NL](#) [PA1292.112NLT](#) [PA1494.242NLT](#) [PA1494.442NLT](#) [PA1292.132NL](#) [PA1292.132NLT](#) [PA1292.650NL](#)
[PA1393.102NL](#) [PA1393.102NLT](#) [PA1292.650NLT](#)