

Description

Schottky rectifier suited for switch mode power supply and high frequency DC to DC converters.

Packaged in PowerFLAT™, this device is intended for use in low voltage, high frequency inverters, free-wheeling and polarity protection applications.

Its low profile was especially designed to be used in applications with space-saving constraints.

Table 1. Device summary

Symbol	Value
$I_{F(AV)}$	30 A
V_{RRM}	45 V
T_j (max)	175 °C (up to 200 °C forward mode only for PowerFLAT 5x6)
V_F (typ)	0.50 V

Features

- Low forward voltage drop
- Very small conduction losses
- Negligible switching losses
- Extremely fast switching
- Low thermal resistance
- Avalanche capability specified
- Thin package: 1 mm
- ECOPACK®2 compliant component

TM: PowerFLAT is a trademark of STMicroelectronics

1 Characteristics

Table 2. Absolute ratings (limiting values, at 25 °C unless otherwise specified, anode terminals short-circuited)

Symbol	Parameter		Value	Unit
V_{RRM}	Repetitive peak reverse voltage		45	V
$I_{F(RMS)}$	Forward rms current		45	A
$I_{F(AV)}$	Average forward current	$T_c = 120\text{ °C}, \delta = 0.5$	30	A
I_{FSM}	Surge non repetitive forward current	$t_p = 10\text{ ms sinusoidal}$ $T_c = 25\text{ °C}$	380	A
P_{ARM}	Repetitive peak avalanche power	$t_p = 10\text{ }\mu\text{s}$ $T_j = 125\text{ °C}$	900	W
T_{stg}	Storage temperature range		-65 to +175	°C
T_j	Maximum operating junction temperature ⁽¹⁾	PowerFLAT 5x6	175	°C
		PowerFLAT 5x6 (DC forward current without a reverse bias, $t = 1\text{ hour}$)	200	°C

1. $\frac{dP_{tot}}{dT_j} < \frac{1}{R_{th(j-a)}}$ condition to avoid thermal runaway for a diode on its own heatsink

Table 3. Thermal resistance

Symbol	Parameter	Value	Unit
$R_{th(j-c)}$	Junction to case	2.5	°C/W

Table 4. Static electrical characteristics (anode terminals short circuited)

Symbol	Parameter	Test Conditions	Min.	Typ.	Max.	Unit	
$I_R^{(1)}$	Reverse leakage current	$T_j = 25\text{ °C}$	$V_R = V_{RRM}$	-	-	300	μA
		$T_j = 125\text{ °C}$		-	20	80	mA
$V_F^{(1)}$	Forward voltage drop	$T_j = 25\text{ °C}$	$I_F = 15\text{ A}$	-	-	0.56	V
		$T_j = 125\text{ °C}$		-	0.41	0.46	
		$T_j = 25\text{ °C}$	$I_F = 30\text{ A}$	-	-	0.64	
		$T_j = 125\text{ °C}$		-	0.50	0.56	

1. Pulse test: $t_p = 380\text{ }\mu\text{s}, \delta < 2\%$

To evaluate the conduction losses use the following equation:

$$P = 0.43 \times I_{F(AV)} + 0.00433 I_{F(RMS)}^2$$

1.1 Characteristics (curves)

Figure 1. Average forward power dissipation versus average forward current

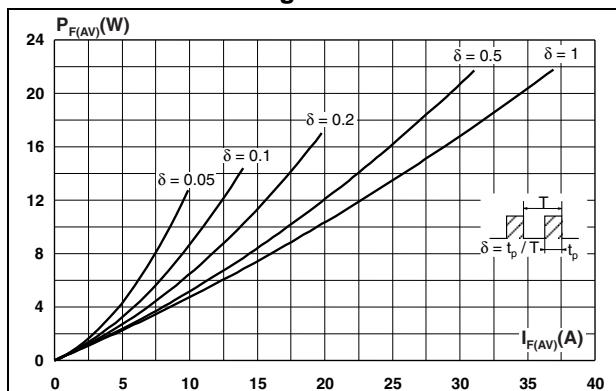

Figure 2. Average forward current versus ambient temperature ($\delta = 0.5$)

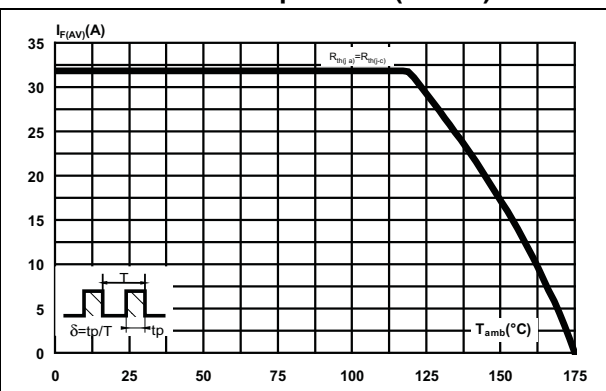

Figure 3. Normalized avalanche power derating versus pulse duration ($T_j = 125^\circ\text{C}$)

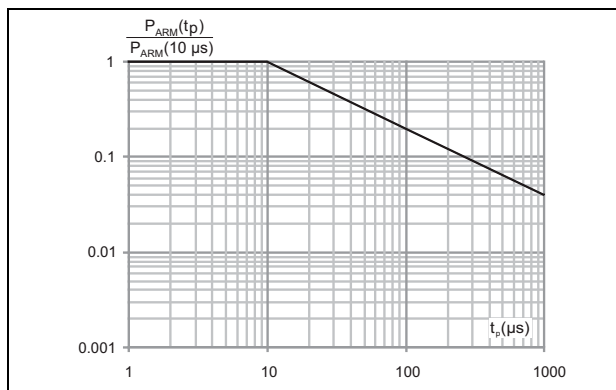

Figure 4. Relative variation of thermal impedance, junction to case, versus pulse duration

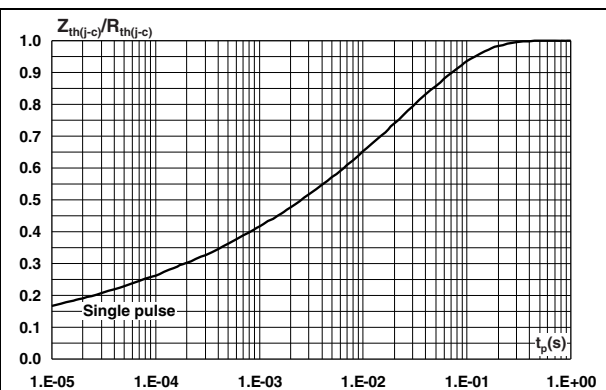

Figure 5. Reverse leakage current versus reverse voltage applied (typical values)

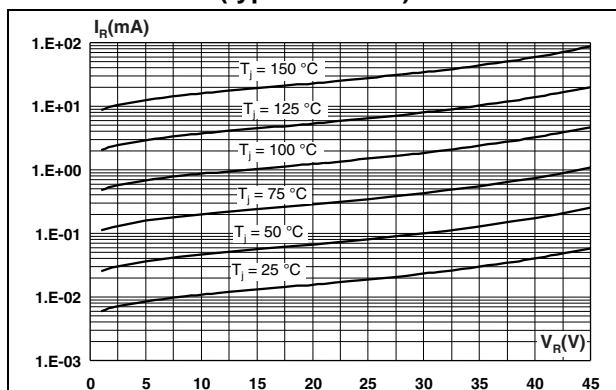

Figure 6. Junction capacitance versus reverse voltage applied (typical values)

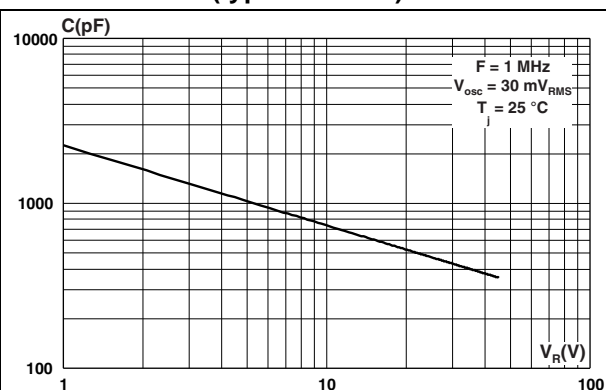

Figure 7. Forward voltage drop versus forward current

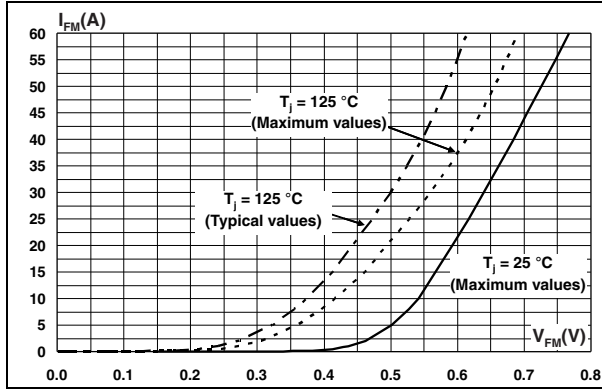
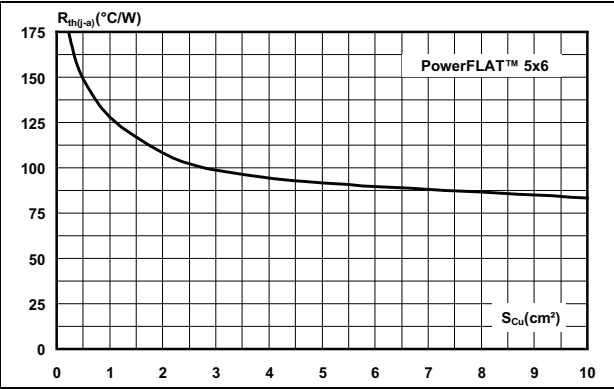

Figure 8. Thermal resistance, junction to ambient, versus copper surface under tab (typical values, epoxy printed board FR4, $e_{CU} = 35\mu\text{m}$)



2 Package information

- Epoxy meets UL94,V0
- Lead-free package

In order to meet environmental requirements, ST offers these devices in different grades of ECOPACK® packages, depending on their level of environmental compliance. ECOPACK® specifications, grade definitions and product status are available at: www.st.com. ECOPACK® is an ST trademark.

Table 5. PowerFLAT 5x6 dimensions

Ref.	Dimensions					
	Millimeters			Inches		
	Min.	Typ.	Max.	Min.	Typ.	Max.
A	0.80		1.00	0.031		0.039
A1	0.02		0.05	0.001		0.002
A2		0.25			0.010	
b	0.30		0.50	0.012		0.020
D		5.20			0.205	
D2	4.11		4.31	0.162		0.170
e		1.27			0.050	
E		6.15			0.242	
E2	3.50		3.70	0.138		0.146
L	0.50		0.80	0.020		0.031
K	1.275		1.575	0.050		0.062

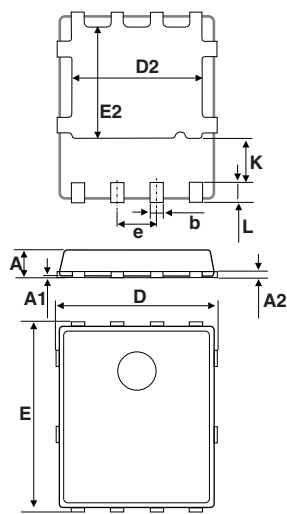

Figure 9. Footprint (dimensions in mm)

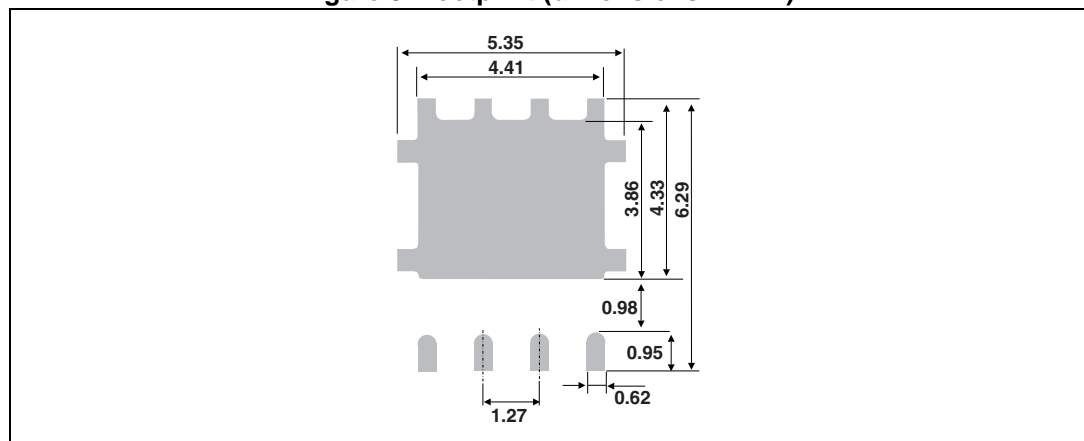
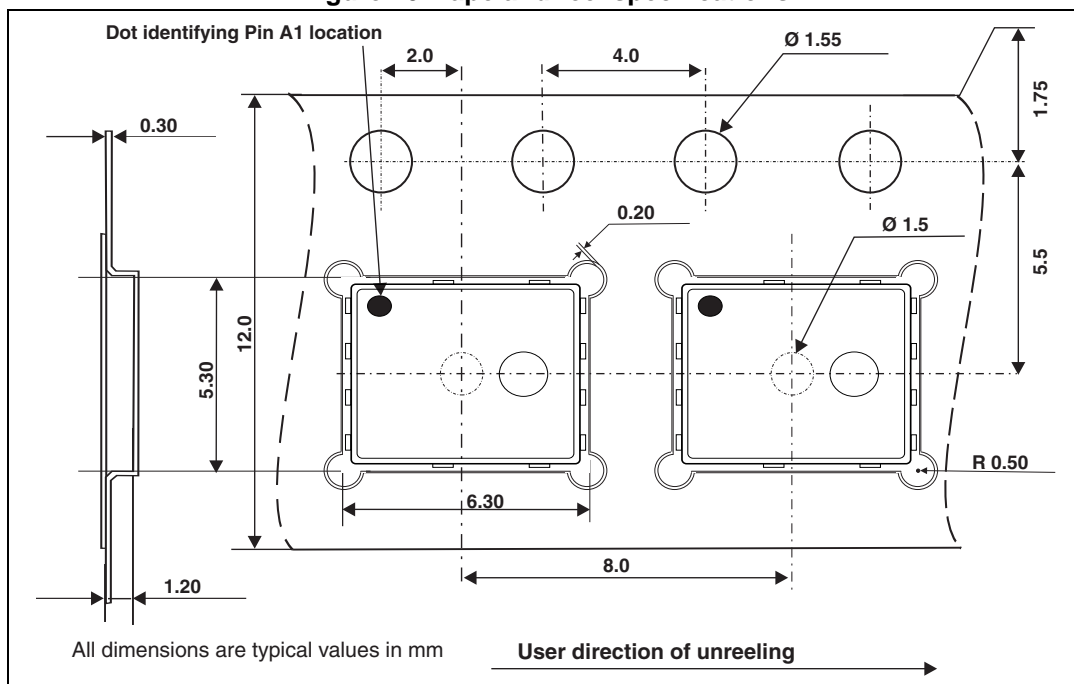

Figure 10. Tape and reel specifications



3 Ordering information

Table 6. Ordering information

Order code	Marking	Package	Weight	Base qty	Delivery mode
STPS3045DJF-TR	PS30 45	PowerFLAT 5x6	95 mg	3000	Tape and reel

4 Revision history

Table 7. Document revision history

Date	Revision	Changes
09-Nov-2009	1	First issue.
05-Jul-2010	2	Replace Power QFN with PowerFLAT.
20-May-2011	3	Updated package graphics and marking in Table 6 . Added Figure 10 .
12-Aug-2015	4	Updated cover image and Table 1 on cover page. Updated Table 2 and Section 1.1: Characteristics (curves) .

IMPORTANT NOTICE – PLEASE READ CAREFULLY

STMicroelectronics NV and its subsidiaries ("ST") reserve the right to make changes, corrections, enhancements, modifications, and improvements to ST products and/or to this document at any time without notice. Purchasers should obtain the latest relevant information on ST products before placing orders. ST products are sold pursuant to ST's terms and conditions of sale in place at the time of order acknowledgement.

Purchasers are solely responsible for the choice, selection, and use of ST products and ST assumes no liability for application assistance or the design of Purchasers' products.

No license, express or implied, to any intellectual property right is granted by ST herein.

Resale of ST products with provisions different from the information set forth herein shall void any warranty granted by ST for such product.

ST and the ST logo are trademarks of ST. All other product or service names are the property of their respective owners.

Information in this document supersedes and replaces information previously supplied in any prior versions of this document.

© 2015 STMicroelectronics – All rights reserved

Mouser Electronics

Authorized Distributor

Click to View Pricing, Inventory, Delivery & Lifecycle Information:

[STMicroelectronics:](#)

[STPS3045DJF-TR](#)