

PAGE 1/3	ISSUE 1438C	SERIES SMP	PART NUMBER R222302002
----------	-------------	------------	------------------------

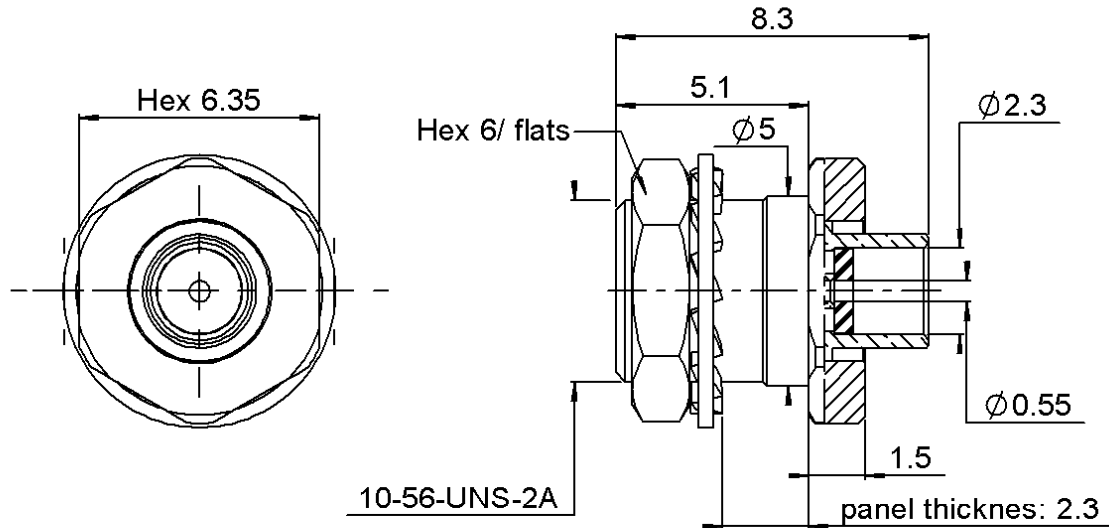

PANEL CUT OUT

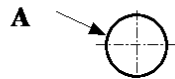

	mm	
	Maxi	mini
A	5.30	5.20

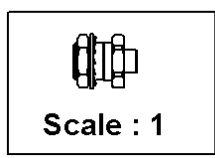
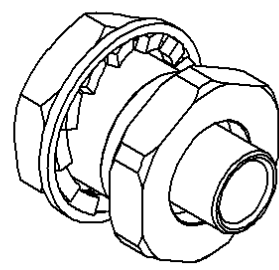

All dimensions are in mm.

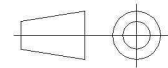

COMPONENTS	MATERIALS	PLATING (µm)
Body	STAINLESS STEEL + BRASS	PASSIVATED+GOLD1.3 OVER NICKEL2
Center contact	BERYLLIUM COPPER	GOLD 1.27 OVER NICKEL 1.27
Outer contact	-	-
Insulator	PTFE	-
Gasket	-	-
Others parts	BRASS	NICKEL 2
-	-	-
-	-	-

PAGE 2/3	ISSUE 1438C	SERIES SMP	PART NUMBER R222302002
-----------------	--------------------	-------------------	-------------------------------

PACKAGING

Standard	Unit	Other
100	Contact us	Contact us

ELECTRICAL CHARACTERISTICS

Impedance	50	Ω
Frequency	0-40	GHz
VSWR	1.50 + 0,0000	x F(GHz) Maxi
Insertion loss	0.12	\sqrt{F} (GHz) dB Maxi
RF leakage	- (- F(GHz)) dB Maxi
Voltage rating	335	Veff Maxi
Dielectric withstanding voltage	500	Veff mini
Insulation resistance	5000	M Ω mini

MECHANICAL CHARACTERISTICS

Center contact retention		
Axial force – Mating End	NA	N mini
Axial force – Opposite end	NA	N mini
Torque	NA	N.cm mini
Recommended torque		
Mating	NA	N.cm
Panel nut	60	N.cm
Clamp nut	NA	N.cm
A/F clamp nut	0,0000	mm
Mating life	100	Cycles mini
Weight	1,1400	g

ENVIRONMENTAL

Operating temperature	-65/+165	$^{\circ}\text{C}$
Hermetic seal	NA	Atm.cm3/s
Panel leakage	NA	

SPECIFICATION

CABLE ASSEMBLY

Stripping	a	b	c	d	e	f
mm	1,3	0	0	0	0	0

Assembly instruction:

Recommended cable(s)

RG 405
KS 1

Characteristics indicated on this data sheet are those that can be achieved with the highest performance cable. Intrinsic limitations of the cable may diminish the performance of the assembly

Cable retention

- pull off	200	N mini
- torque	NA	N.cm

TOOLING

Part Number	Description	Hexagon
R282051000	STRIPPING TOOL	
R282062010	POINTER GAUGE	
R282743100	POSITIONER FOR SOLDERING SMP	
R282744254	POSITIONER FOR SOLDERING SMP	
R282862120	SOLDER GAUGE THCK 1.83	
R282740000	SOLDERING MOUNTING	

OTHER CHARACTERISTICS

RF leakage -80dB DC-3GHz
-65dB 3-26.5 GHz
Compliant with MIL-STD-348

PAGE 3/3	ISSUE 1438C	SERIES SMP	PART NUMBER R222302002
----------	-------------	------------	------------------------

COMPONENTS

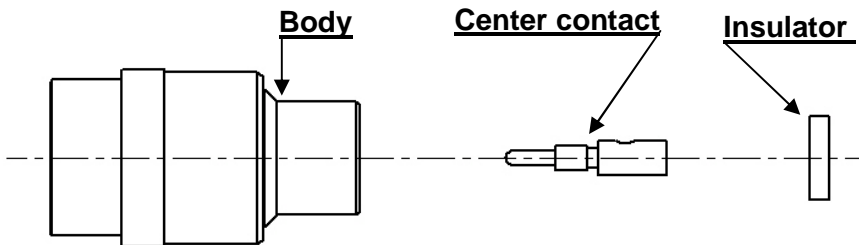

STRIPPING CABLES

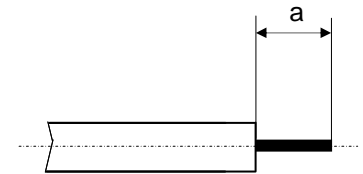

We recommend a thermal preconditioning cable

1

Strip the dielectric of the cable .
Clean the cable .
Soldering 180°C
Temperature stoking do not exceeded 250°C

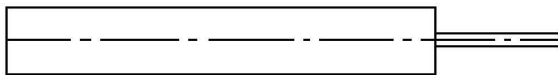

2

Screw the positioner onto the soldering jig.
Slide the center contact onto the cable inner conductor against insulator.
Fit the cable assembly onto the soldering jig.
Insert the soldering gauge
Tighten.
Take off the soldering gauge.
and solder the contact.

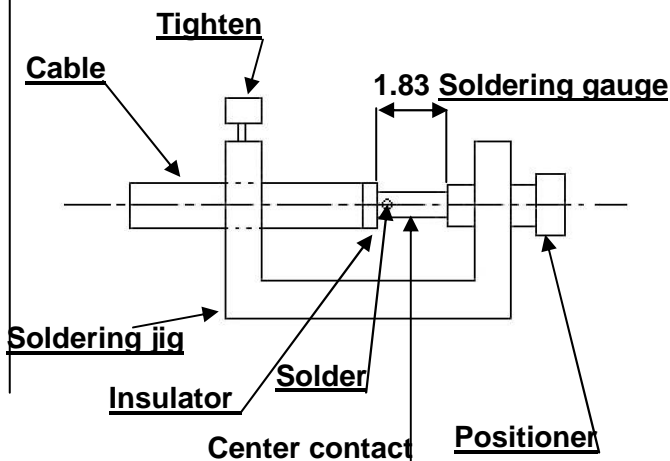

3

After cooling remove cable assembly from the jig.
Insert cable+centre contact in the connector.
Slide the positioner in the connector interface.
Slide cable into the connector body until it bottoms against.
Slide positioner into the assembly.
Tighten.
Solder the body onto the cable.
After cooling remove cable assembly from the jig.

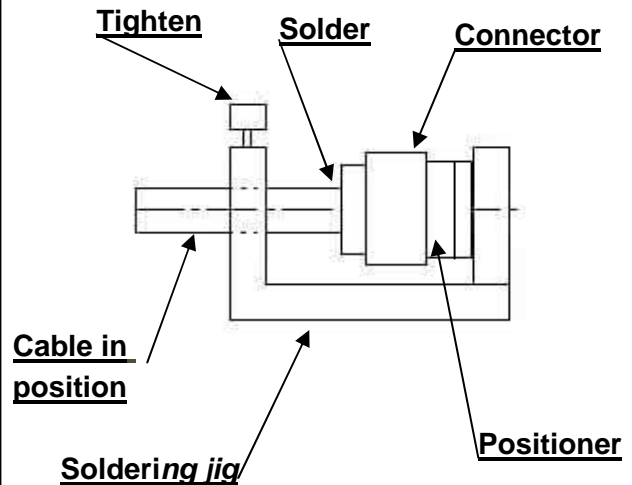

Mouser Electronics

Authorized Distributor

Click to View Pricing, Inventory, Delivery & Lifecycle Information:

Radial:

[R222302002](#) [R222302002W](#)