

## 8V to 36V<sub>IN</sub> Cool-Power ZVS Buck Regulator Family

### Product Description

The PI33xx-x0 is a family of high efficiency, wide input range DC-DC ZVS-Buck regulators integrating controller, power switches, and support components all within a high density System-in-Package (SiP). The integration of a high performance Zero-Voltage Switching (ZVS) topology, within the PI33xx-x0 series, increases point of load performance providing best in class power efficiency. The PI33xx-x0 requires only an external inductor and minimal capacitors to form a complete DC-DC switching mode Buck Regulator.

Device	Output Voltage		I <sub>OUT</sub> Max
	Set	Range	
<a href="#">PI3311-x0</a>	1.0V	1.0 to 1.4V	10A
<a href="#">PI3318-x0</a>	1.8V	1.4 to 2.0V	10A
<a href="#">PI3312-x0</a>	2.5V	2.0 to 3.1V	10A
<a href="#">PI3301-x0</a>	3.3V	2.3 to 4.1V	10A
<a href="#">PI3302-x0</a>	5.0V	3.3 to 6.5V	10A
<a href="#">PI3303-x0</a>	12V	6.5 to 13.0V	8A
<a href="#">PI3305-x0</a>	15V	10.0 to 16.0V	8A

The ZVS architecture also enables high frequency operation while minimizing switching losses and maximizing efficiency. The high switching frequency operation reduces the size of the external filtering components, improves power density, and enables very fast dynamic response to line and load transients. The PI33xx-x0 series sustains high switching frequency all the way up to the rated input voltage without sacrificing efficiency and, with its 20ns minimum on-time, supports large step down conversions up to 36V<sub>IN</sub>.

### Features & Benefits

- High Efficiency ZVS-Buck Topology
- Wide input voltage range of 8V to 36V
- Very-Fast transient response
- High accuracy pre-trimmed output voltage
- User adjustable soft-start & tracking
- Power-up into pre-biased load (select versions)
- Parallel capable with single wire current sharing
- Input Over/Undervoltage Lockout (OVLO/UVLO)
- Output Overvoltage Protection (OVP)
- Overtemperature Protection (OTP)
- Fast and slow current limits
- -40°C to 125°C operating range (T<sub>J</sub>)
- Optional I<sup>2</sup>C™ \* functionality & programmability:
  - V<sub>OUT</sub> margining
  - Fault reporting
  - Enable and SYNC1 pin polarity
  - Phase delay (interleaving multiple regulators)

### Applications

- High efficiency systems
- High voltage battery operation

### Package Information

- 10mm x 14mm x 2.6mm LGA SiP



\* I<sup>2</sup>C™ is a trademark of NXP Semiconductors

## Contents

Order Information	3	Application Description	34
I <sup>2</sup> C™ Functionality & Programmability	3	Output Voltage Trim	34
Absolute Maximum Ratings	4	Soft-Start Adjust and Tracking	35
Functional Block Diagram	4	Inductor Pairing	36
Pin Description	5	Thermal Derating	36
Package Pin-Out	5	Filter Considerations	36
PI3311-x0-LGIZ (1.0V <sub>OUT</sub> ) Electrical Characteristics	6	Layout Guidelines	37
PI3318-x0-LGIZ (1.8V <sub>OUT</sub> ) Electrical Characteristics	9	Recommended PCB Footprint and Stencil	38
PI3312-x0-LGIZ (2.5V <sub>OUT</sub> ) Electrical Characteristics	12	LGIZ Package Drawing	39
PI3301-x0-LGIZ (3.3V <sub>OUT</sub> ) Electrical Characteristics	16	Revision History	40
PI3302-x0-LGIZ (5.0V <sub>OUT</sub> ) Electrical Characteristics	20	Warranty	41
PI3303-x0-LGIZ (12.0V <sub>OUT</sub> ) Electrical Characteristics	24		
PI3305-x0-LGIZ (15.0V <sub>OUT</sub> ) Electrical Characteristics	28		
Functional Description	32		
ENABLE (EN)	32		
Remote Sensing	32		
Switching Frequency Synchronization	32		
Soft-Start	32		
Output Voltage Trim	32		
Output Current Limit Protection	33		
Input Undervoltage Lockout	33		
Input Overvoltage Lockout	33		
Output Overvoltage Protection	33		
Overtemperature Protection	33		
Pulse Skip Mode (PSM)	33		
Variable Frequency Operation	33		
Parallel Operation	33		
I <sup>2</sup> C Interface Operation	34		

## Order Information

Cool-Power	Output Range		I <sub>OUT</sub> Max	Package	Transport Media
	Set	Range			
PI3311-00-LGIZ	1.0V	1.0 to 1.4V	10A	10mm x 14mm 123-pin LGA	TRAY
PI3318-00-LGIZ	1.8V	1.4 to 2.0V	10A	10mm x 14mm 123-pin LGA	TRAY
PI3312-00-LGIZ	2.5V	2.0 to 3.1V	10A	10mm x 14mm 123-pin LGA	TRAY
PI3301-00-LGIZ	3.3V	2.3 to 4.1V	10A	10mm x 14mm 123-pin LGA	TRAY
PI3302-00-LGIZ	5.0V	3.3 to 6.5V	10A	10mm x 14mm 123-pin LGA	TRAY
PI3303-00-LGIZ	12V	6.5 to 13.0V	8A	10mm x 14mm 123-pin LGA	TRAY
PI3305-00-LGIZ	15V	10.0 to 16.0V	8A	10mm x 14mm 123-pin LGA	TRAY

I<sup>2</sup>C™ Functionality & Programmability

Cool-Power	Output Range		I <sub>OUT</sub> Max	Package	Transport Media
	Set	Range			
PI3311-20-LGIZ	1.0V	1.0 to 1.4V	10A	10mm x 14mm 123-pin LGA	TRAY
PI3318-20-LGIZ	1.8V	1.4 to 2.0V	10A	10mm x 14mm 123-pin LGA	TRAY
PI3312-20-LGIZ	2.5V	2.0 to 3.1V	10A	10mm x 14mm 123-pin LGA	TRAY
PI3301-20-LGIZ	3.3V	2.3 to 4.1V	10A	10mm x 14mm 123-pin LGA	TRAY
PI3302-20-LGIZ	5.0 V	3.3 to 6.5V	10A	10mm x 14mm 123-pin LGA	TRAY
PI3303-20-LGIZ	12V	6.5 to 13.0V	8A	10mm x 14mm 123-pin LGA	TRAY
PI3305-20-LGIZ	15V	10.0 to 16.0V	8A	10mm x 14mm 123-pin LGA	TRAY

### Absolute Maximum Ratings

Name		Rating
V <sub>IN</sub>		-0.7 to 36V
VS1		-0.7 to 36V <sub>DC</sub>
SGND		100mA
PWRGD, SYNCO, SYNCI, EN, EAO, ADJ, TRK, ADR1, ADR2, SCL, SDA, REM		-0.3V to 5.5V / 5mA
V <sub>OUT</sub>	PI3311-x0-LGIZ	-0.3V to 5.5V
	PI3318-x0-LGIZ	-0.5V to 9V
	PI3312-x0-LGIZ	-0.8V to 13V
	PI3301-x0-LGIZ	-1.0V to 18V
	PI3302-x0-LGIZ	-1.5V to 21V
	PI3303-x0-LGIZ	-3.6V to 25V
	PI3305-x0-LGIZ	-4.5V to 25V
Storage Temperature		-65°C to 150°C
Operating Junction Temperature		-40°C to 125°C
Soldering Temperature for 20 seconds		245°C
ESD Rating		2kV HBM

**Notes:** At 25°C ambient temperature. Stresses beyond these limits may cause permanent damage to the device. Operation at these conditions or conditions beyond those listed in the Electrical Specifications table is not guaranteed. All voltage nodes are referenced to PGND unless otherwise noted. Test conditions are per the specifications within the individual product electrical characteristics.

### Functional Block Diagram

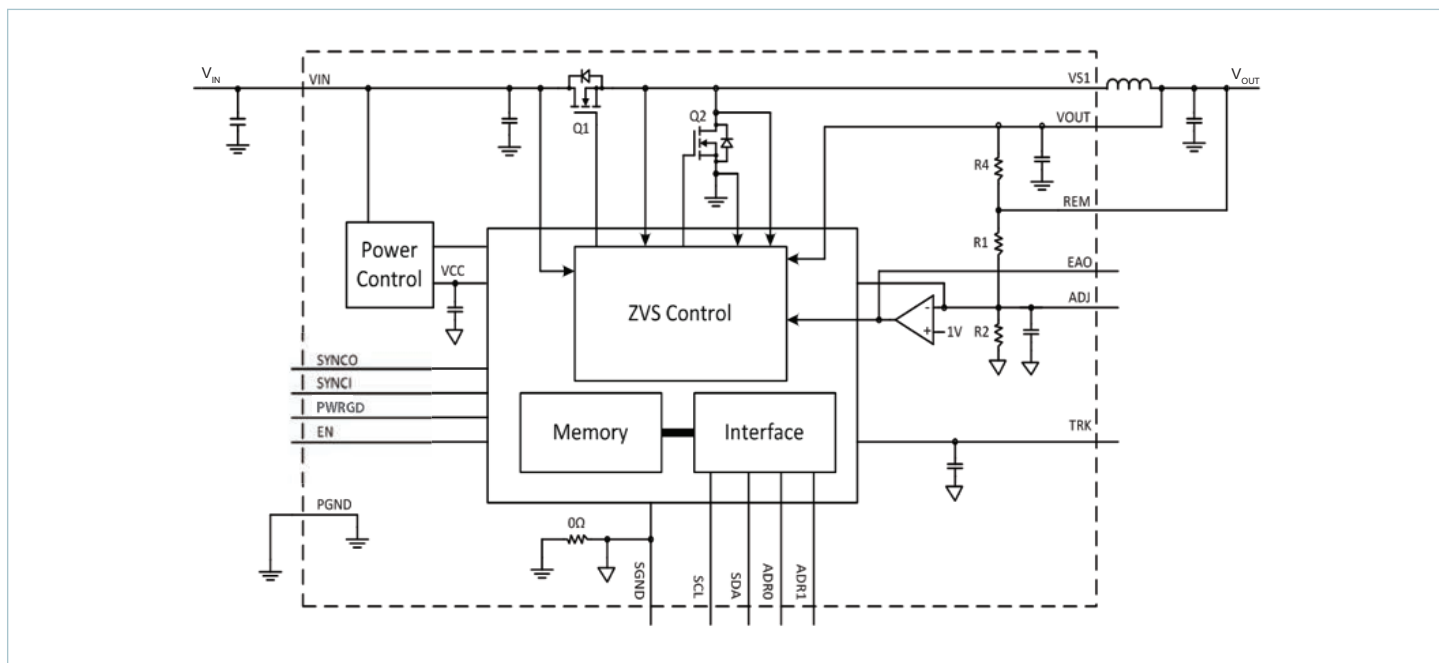

*Simplified Block Diagram (I<sup>2</sup>C™ pins SCL, SDA, ADR0, and ADR1 only active for PI33xx-20 device versions)*

## Pin Description

Pin Name	Number	Description
SGND	Block 1	<b>Signal Ground:</b> Internal logic ground for EA, TRK, SYNCI, SYNCO, ADJ and I <sup>2</sup> C (options) communication returns. SGND and PGND are star connected within the regulator package.
PGND	Block 2	<b>Power Ground:</b> V <sub>IN</sub> and V <sub>OUT</sub> power returns.
VIN	Block 3	<b>Input Voltage:</b> and sense for UVLO, OVLO and feed forward ramp.
VOUT	Block 5	<b>Output Voltage:</b> and sense for power switches and feed-forward ramp.
VS1	Block 4	<b>Switching Node:</b> and ZVS sense for power switches.
PWRGD	A1	<b>Power Good:</b> High impedance when regulator is operating and V <sub>OUT</sub> is in regulation. Otherwise pulls to SGND. Also can be used for parallel timing management intended for lead regulator.
EAO	A2	<b>Error Amp Output:</b> External connection for additional compensation and current sharing.
EN	A3	<b>Enable Input:</b> Regulator enable control. Asserted high or left floating – regulator enabled; Asserted low, regulator output disabled. Polarity is programmable via I <sup>2</sup> C interface.
REM	A5	<b>Remote Sense:</b> High side connection. Connect to output regulation point.
ADJ	B1	<b>Adjust Input:</b> An external resistor may be connected between ADJ pin and SGND or VOUT to trim the output voltage up or down.
TRK	C1	<b>Soft-start and Track Input:</b> An external capacitor may be connected between TRK pin and SGND to decrease the rate of rise during soft-start.
NC	A4	<b>No Connect:</b> Leave pins floating.
VDR	K3	VDR can only be used for ADR0 and ADR1 pull up reference voltage. No other external loading is permitted
SYNCO	K4	<b>Synchronization Output:</b> Outputs a low signal for ½ of the minimum period for synchronization of other converters.
SYNCI	K5	<b>Synchronization Input:</b> Synchronize to the falling edge of external clock frequency. SYNCI is a high impedance digital input node and should always be connected to SGND when not in use.
SDA	D1	<b>Data Line:</b> Connect to SGND for PI33xx-00. For use with PI33xx-20 only.
SCL	E1	<b>Clock Line:</b> Connect to SGND for PI33xx-00. For use with PI33xx-20 only.
ADR1	H1	<b>Tri-state Address:</b> No connect for PI33xx-00. For use with PI33xx-20 only.
ADR0	G1	<b>Tri-state Address:</b> No connect for PI33xx-00. For use with PI33xx-20 only.

## Package Pin-Out

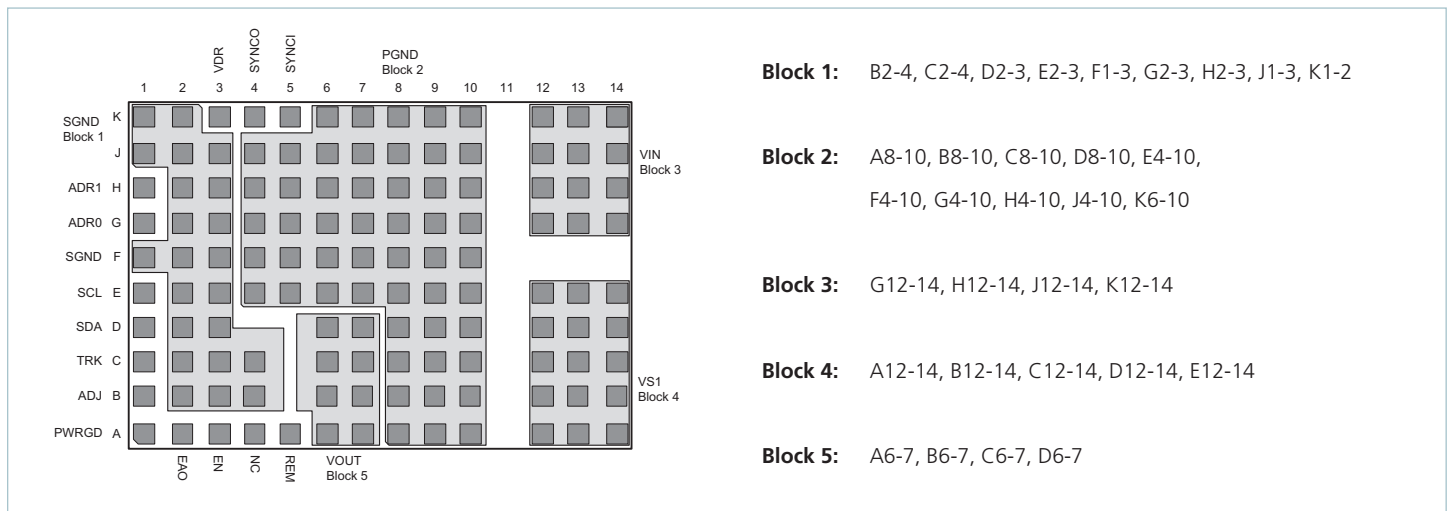

PI3311-x0-LGIZ (1.0V<sub>OUT</sub>) Electrical Characteristics

Unless otherwise specified:  $-40^{\circ}\text{C} < T_J < 125^{\circ}\text{C}$ ,  $V_{IN} = 24\text{V}$ ,  $L_1 = 125\text{nH}$  <sup>[1]</sup>

Parameter	Symbol	Conditions	Min	Typ	Max	Unit
<b>Input Specifications</b>						
Input Voltage	$V_{IN\_DC}$		8	24	36	V
Input Current	$I_{IN\_DC}$	$V_{IN} = 24\text{V}$ , $T_C = 25^{\circ}\text{C}$ , $I_{OUT} = 10\text{A}$		476		mA
Input Current At Output Short (fault condition duty cycle)	$I_{IN\_Short}$	<sup>[2]</sup>			20	mA
Input Quiescent Current	$I_{Q\_VIN}$	Disabled		2.0		mA
		Enabled (no load)		2.5		mA
Input Voltage Slew Rate	$V_{IN\_SR}$				1	V/ $\mu\text{s}$
<b>Output Specifications</b>						
Output Voltage Total Regulation	$V_{OUT\_DC}$	<sup>[2]</sup>	0.987	1.0	1.013	V
Output Voltage Trim Range	$V_{OUT\_DC}$	<sup>[3]</sup>	1.0		1.4	V
Line Regulation	$\Delta V_{OUT} (\Delta V_{IN})$	@25 $^{\circ}\text{C}$ , $8\text{V} < V_{IN} < 36\text{V}$		0.10		%
Load Regulation	$\Delta V_{OUT} (\Delta I_{OUT})$	@25 $^{\circ}\text{C}$ , $0.5\text{A} < I_{OUT} < 10\text{A}$		0.10		%
Output Voltage Ripple	$V_{OUT\_AC}$	$I_{OUT} = 5\text{A}$ , $C_{OUT} = 8 \times 100\mu\text{F}$ , 20MHz BW <sup>[4]</sup>		20		mVp-p
Continuous Output Current Range	$I_{OUT\_DC}$	<sup>[5]</sup> Minimum 1mA load required	0.001		10	A
Current Limit	$I_{OUT\_CL}$			12		A
<b>Protection</b>						
$V_{IN}$ UVLO Start Threshold	$V_{UVLO\_START}$		7.10	7.60	8.00	V
$V_{IN}$ UVLO Stop Threshold	$V_{UVLO\_STOP}$		6.80	7.25	7.60	V
$V_{IN}$ UVLO Hysteresis	$V_{UVLO\_HYS}$			0.33		V
$V_{IN}$ OVLO Start Threshold	$V_{OVLO\_START}$		36.1			V
$V_{IN}$ OVLO Stop Threshold	$V_{OVLO\_STOP}$		37.0	38.4		V
$V_{IN}$ OVLO Hysteresis	$V_{OVLO\_HYS}$			0.77		V
$V_{IN}$ UVLO/OVLO Response Time	$t_f$			500		ns
Output Overvoltage Protection	$V_{OVP}$	Above $V_{OUT}$		20		%
Overtemperature Fault Threshold	$T_{OTP}$		130	135	140	$^{\circ}\text{C}$
Overtemperature Restart Hysteresis	$T_{OTP\_HYS}$			30		$^{\circ}\text{C}$

<sup>[1]</sup> All parameters reflect regulator and inductor system performance. Measurements were made using a standard PI33xx-x0 evaluation board with 3x4" dimensions and 4 layer, 2oz copper. Refer to inductor pairing table within Application Description section for specific inductor manufacturer and value.

<sup>[2]</sup> Regulator is assured to meet performance specifications by design, test correlation, characterization, and/or statistical process control.

<sup>[3]</sup> Output current capability may be limited and other performance may vary from electrical characteristics when switching frequency or  $V_{OUT}$  is modified.

<sup>[4]</sup> Refer to Output Ripple plots.

<sup>[5]</sup> Refer to Load Current vs. Ambient Temperature curves.

<sup>[6]</sup> Refer to Switching Frequency vs. Load current curves.

PI3311-x0-LGIZ (1.0V<sub>OUT</sub>) Electrical Characteristics (Cont.)

Unless otherwise specified:  $-40^{\circ}\text{C} < T_J < 125^{\circ}\text{C}$ ,  $V_{IN} = 24\text{V}$ ,  $L1 = 125\text{nH}$  <sup>[1]</sup>

Parameter	Symbol	Conditions	Min	Typ	Max	Unit
<b>Timing</b>						
Switching Frequency	$f_S$	<sup>[6]</sup>		500		kHz
Fault Restart Delay	$t_{FR\_DLY}$			30		ms
<b>Sync In (SYNCI)</b>						
Synchronization Frequency Range	$\Delta f_{SYNCI}$	Relative to set switching frequency <sup>[3]</sup>	50		110	%
SYNCI Threshold	$V_{SYNCI}$			2.5		V
SYNCI Input Impedance	$Z_{SYNCI}$			100		k $\Omega$
<b>Sync Out (SYNCO)</b>						
SYNCO High	$V_{SYNCO\_HI}$	Source 1mA	4.5			V
SYNCO Low	$V_{SYNCO\_LO}$	Sink 1mA			0.5	V
SYNCO Rise Time	$t_{SYNCO\_RT}$	20pF load		10		ns
SYNCO Fall Time	$t_{SYNCO\_FT}$	20pF load		10		ns
<b>Soft Start And Tracking</b>						
TRK Active Input Range	$V_{TRK}$	Internal reference tracking range	0		1.04	V
TRK Max Output Voltage				1.2		V
TRK Disable Threshold	$V_{TRK\_OV}$		20	40	60	mV
Charge Current (Soft – Start)	$I_{TRK}$		70	50	30	$\mu\text{A}$
Discharge Current (Fault)	$I_{TRK\_DIS}$	$V_{TRK} = 0.5\text{V}$		6.8		mA
Soft-Start Time	$t_{SS}$	$C_{TRK} = 0\mu\text{F}$		2.2		ms
<b>Enable</b>						
High Threshold	$V_{EN\_HI}$		0.9	1	1.1	V
Low Threshold	$V_{EN\_LO}$		0.7	0.8	0.9	V
Threshold Hysteresis	$V_{EN\_HYS}$		100	200	300	mV
Enable Pull-Up Voltage (Floating)	$V_{EN\_PU}$	With positive logic EN polarity		2		V
Enable Pull-Down Voltage (Floating)	$V_{EN\_PD}$	With negative logic EN polarity		0		V
Source Current	$I_{EN\_SO}$	With positive logic EN polarity		50		$\mu\text{A}$
Sink Current	$I_{EN\_SK}$	With negative logic EN polarity		50		$\mu\text{A}$

<sup>[1]</sup> All parameters reflect regulator and inductor system performance. Measurements were made using a standard PI33xx-x0 evaluation board with 3x4" dimensions and 4 layer, 2oz copper. Refer to inductor pairing table within Application Description section for specific inductor manufacturer and value.

<sup>[2]</sup> Regulator is assured to meet performance specifications by design, test correlation, characterization, and/or statistical process control.

<sup>[3]</sup> Output current capability may be limited and other performance may vary from electrical characteristics when switching frequency or  $V_{OUT}$  is modified.

<sup>[4]</sup> Refer to Output Ripple plots.

<sup>[5]</sup> Refer to Load Current vs. Ambient Temperature curves.

<sup>[6]</sup> Refer to Switching Frequency vs. Load current curves.

PI3311-x0-LGIZ (1.0V<sub>OUT</sub>) Electrical Characteristics (Cont.)

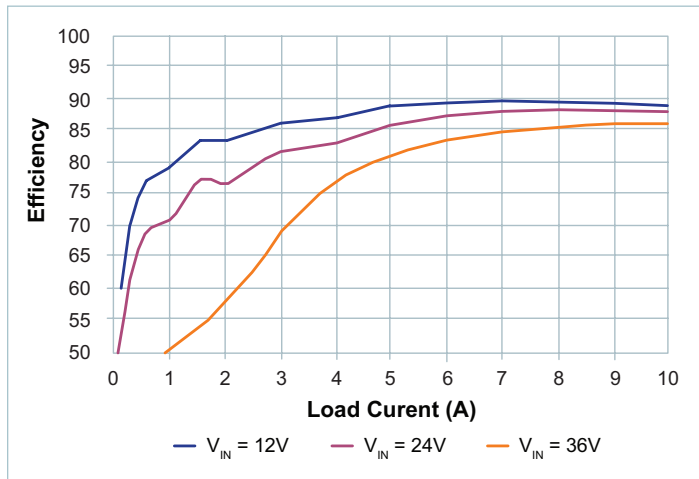

Figure 1 — Efficiency at 25°C

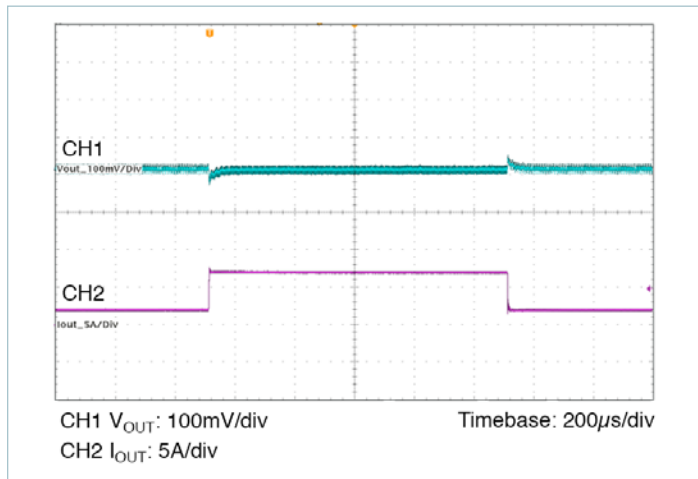

Figure 4 — Transient Response 2A to 7A, at 5A/μs

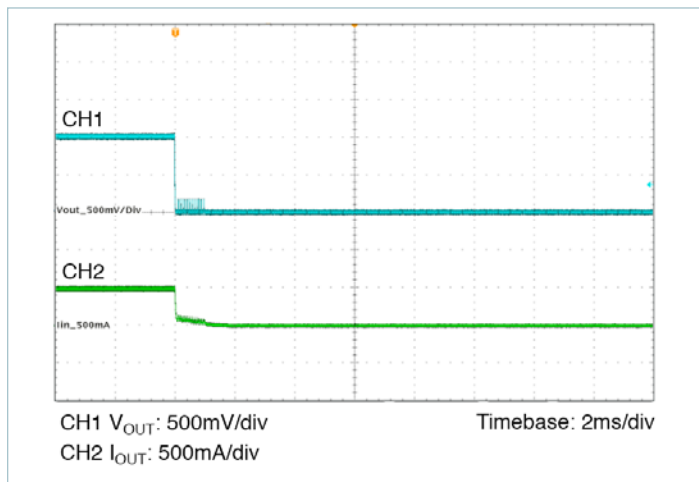

Figure 2 — Short Circuit Test

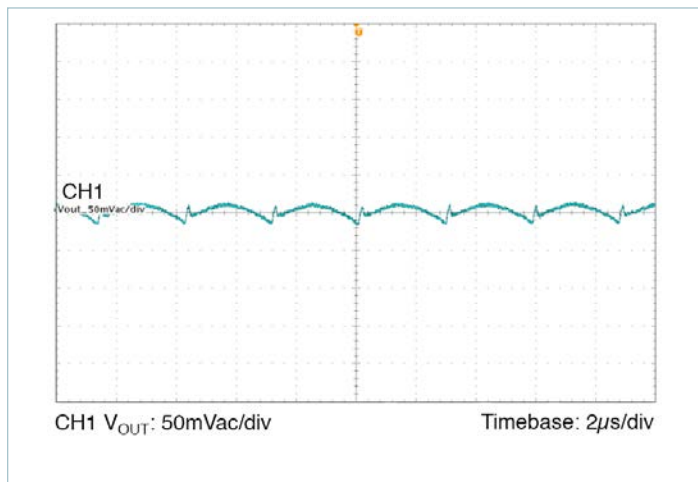

Figure 5 — Output Ripple 24V<sub>IN</sub>, 1.0V<sub>OUT</sub> at 10A

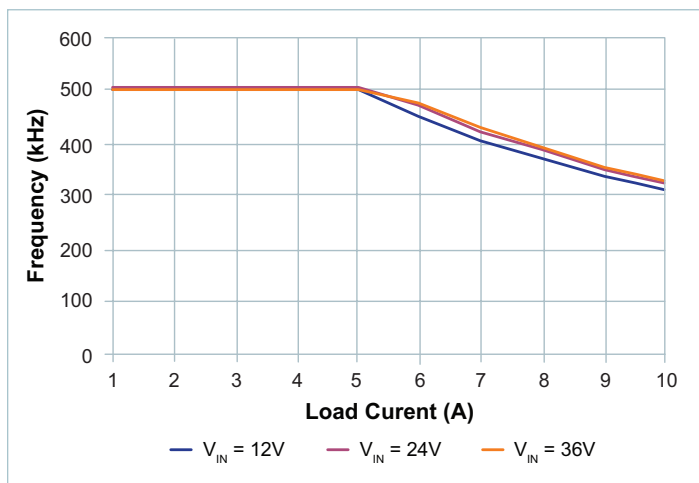

Figure 3 — Switching Frequency vs. Load Current

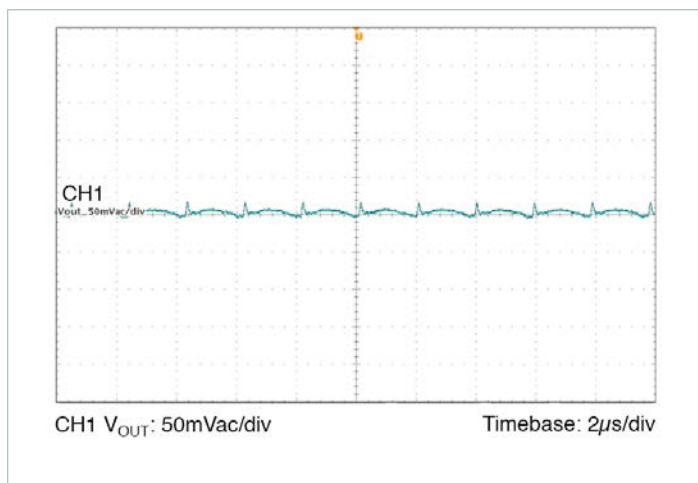

Figure 6 — Output Ripple 24V<sub>IN</sub>, 1.0V<sub>OUT</sub> at 5A



PI3318-x0-LGIZ (1.8V<sub>OUT</sub>) Electrical Characteristics

Unless otherwise specified:  $-40^{\circ}\text{C} < T_J < 125^{\circ}\text{C}$ ,  $V_{IN} = 24\text{V}$ ,  $L1 = 155\text{nH}$  <sup>[1]</sup>

Parameter	Symbol	Conditions	Min	Typ	Max	Unit
<b>Input Specifications</b>						
Input Voltage	$V_{IN\_DC}$		8	24	36	V
Input Current	$I_{IN\_DC}$	$V_{IN} = 24\text{V}$ , $T_C = 25^{\circ}\text{C}$ , $I_{OUT} = 10\text{A}$		835		mA
Input Current At Output Short (fault condition duty cycle)	$I_{IN\_Short}$	<sup>[2]</sup>			20	mA
Input Quiescent Current	$I_{Q\_VIN}$	Disabled		2.0		mA
		Enabled (no load)		2.5		mA
Input Voltage Slew Rate	$V_{IN\_SR}$				1	V/ $\mu\text{s}$
<b>Output Specifications</b>						
Output Voltage Total Regulation	$V_{OUT\_DC}$	<sup>[2]</sup>	1.773	1.8	1.827	V
Output Voltage Trim Range	$V_{OUT\_DC}$	<sup>[3]</sup>	1.4		2.0	V
Line Regulation	$\Delta V_{OUT} (\Delta V_{IN})$	@25°C, $8\text{V} < V_{IN} < 36\text{V}$		0.10		%
Load Regulation	$\Delta V_{OUT} (\Delta I_{OUT})$	@25°C, $0.5\text{A} < I_{OUT} < 10\text{A}$		0.10		%
Output Voltage Ripple	$V_{OUT\_AC}$	$I_{OUT} = 5\text{A}$ , $C_{OUT} = 6 \times 100\mu\text{F}$ , 20MHz BW <sup>[4]</sup>		25		mVp-p
Continuous Output Current Range	$I_{OUT\_DC}$	<sup>[5]</sup> Minimum 1mA load required	0.001		10	A
Current Limit	$I_{OUT\_CL}$			12		A
<b>Protection</b>						
$V_{IN}$ UVLO Start Threshold	$V_{UVLO\_START}$		7.10	7.60	8.00	V
$V_{IN}$ UVLO Stop Threshold	$V_{UVLO\_STOP}$		6.80	7.25	7.60	V
$V_{IN}$ UVLO Hysteresis	$V_{UVLO\_HYS}$			0.33		V
$V_{IN}$ OVLO Start Threshold	$V_{OVLO\_START}$		36.1			V
$V_{IN}$ OVLO Stop Threshold	$V_{OVLO\_STOP}$		37.0	38.4		V
$V_{IN}$ OVLO Hysteresis	$V_{OVLO\_HYS}$			0.77		V
$V_{IN}$ UVLO/OVLO Response Time	$t_f$			500		ns
Output Overvoltage Protection	$V_{OVP}$	Above $V_{OUT}$		20		%
Overtemperature Fault Threshold	$T_{OTP}$		130	135	140	°C
Overtemperature Restart Hysteresis	$T_{OTP\_HYS}$			30		°C

<sup>[1]</sup> All parameters reflect regulator and inductor system performance. Measurements were made using a standard PI33xx-x0 evaluation board with 3x4" dimensions and 4 layer, 2oz copper. Refer to inductor pairing table within Application Description section for specific inductor manufacturer and value.

<sup>[2]</sup> Regulator is assured to meet performance specifications by design, test correlation, characterization, and/or statistical process control.

<sup>[3]</sup> Output current capability may be limited and other performance may vary from electrical characteristics when switching frequency or  $V_{OUT}$  is modified.

<sup>[4]</sup> Refer to Output Ripple plots.

<sup>[5]</sup> Refer to Load Current vs. Ambient Temperature curves.

<sup>[6]</sup> Refer to Switching Frequency vs. Load current curves.

PI3318-x0-LGIZ (1.8V<sub>OUT</sub>) Electrical Characteristics (Cont.)

Unless otherwise specified: -40°C < T<sub>J</sub> < 125°C, V<sub>IN</sub> = 24V, L1 = 155nH<sup>[1]</sup>

Parameter	Symbol	Conditions	Min	Typ	Max	Unit
<b>Timing</b>						
Switching Frequency	f <sub>S</sub>	[6]		600		kHz
Fault Restart Delay	t <sub>FR_DLY</sub>			30		ms
<b>Sync In (SYNCI)</b>						
Synchronization Frequency Range	Δf <sub>SYNCI</sub>	Relative to set switching frequency <sup>[3]</sup>	50		110	%
SYNCI Threshold	V <sub>SYNCI</sub>			2.5		V
SYNCI Input Impedance	Z <sub>SYNCI</sub>			100		kΩ
<b>Sync Out (SYNCO)</b>						
SYNCO High	V <sub>SYNCO_HI</sub>	Source 1mA	4.5			V
SYNCO Low	V <sub>SYNCO_LO</sub>	Sink 1mA			0.5	V
SYNCO Rise Time	t <sub>SYNCO_RT</sub>	20pF load		10		ns
SYNCO Fall Time	t <sub>SYNCO_FT</sub>	20pF load		10		ns
<b>Soft Start And Tracking</b>						
TRK Active Input Range	V <sub>TRK</sub>	Internal reference tracking range	0		1.04	V
TRK Max Output Voltage				1.2		V
TRK Disable Threshold	V <sub>TRK_OV</sub>		20	40	60	mV
Charge Current (Soft – Start)	I <sub>TRK</sub>		70	50	30	μA
Discharge Current (Fault)	I <sub>TRK_DIS</sub>	V <sub>TRK</sub> = 0.5V		6.8		mA
Soft-Start Time	t <sub>SS</sub>	C <sub>TRK</sub> = 0μF		2.2		ms
<b>Enable</b>						
High Threshold	V <sub>EN_HI</sub>		0.9	1	1.1	V
Low Threshold	V <sub>EN_LO</sub>		0.7	0.8	0.9	V
Threshold Hysteresis	V <sub>EN_HYS</sub>		100	200	300	mV
Enable Pull-Up Voltage (Floating)	V <sub>EN_PU</sub>	With positive logic EN polarity		2		V
Enable Pull-Down Voltage (Floating)	V <sub>EN_PD</sub>	With negative logic EN polarity		0		V
Source Current	I <sub>EN_SO</sub>	With positive logic EN polarity		50		μA
Sink Current	I <sub>EN_SK</sub>	With negative logic EN polarity		50		μA

<sup>[1]</sup> All parameters reflect regulator and inductor system performance. Measurements were made using a standard PI33xx-x0 evaluation board with 3x4" dimensions and 4 layer, 2oz copper. Refer to inductor pairing table within Application Description section for specific inductor manufacturer and value.

<sup>[2]</sup> Regulator is assured to meet performance specifications by design, test correlation, characterization, and/or statistical process control.

<sup>[3]</sup> Output current capability may be limited and other performance may vary from electrical characteristics when switching frequency or V<sub>OUT</sub> is modified.

<sup>[4]</sup> Refer to Output Ripple plots.

<sup>[5]</sup> Refer to Load Current vs. Ambient Temperature curves.

<sup>[6]</sup> Refer to Switching Frequency vs. Load current curves.

PI3318-x0-LGIZ (1.8V<sub>OUT</sub>) Electrical Characteristics (Cont.)

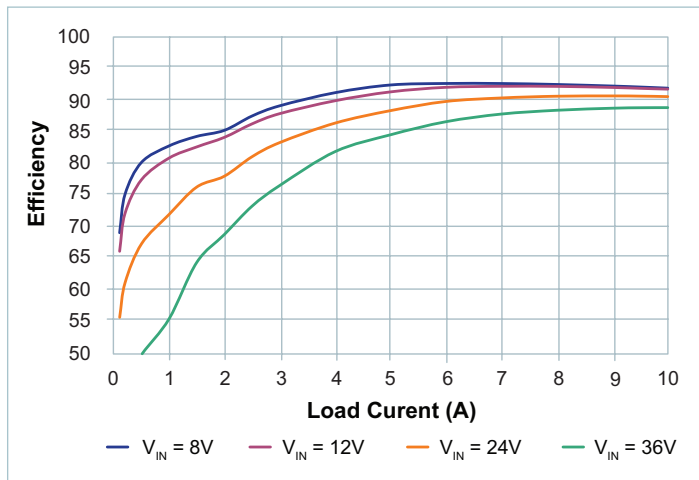

Figure 7 — Efficiency at 25°C

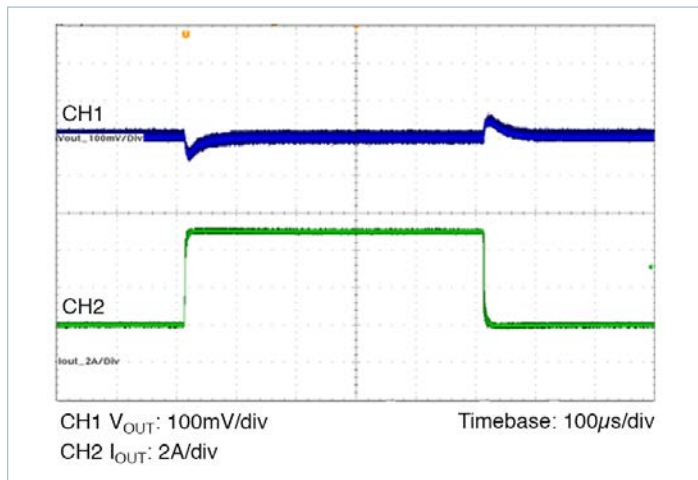

Figure 10 — Transient Response 2A to 7A, at 5A/μs

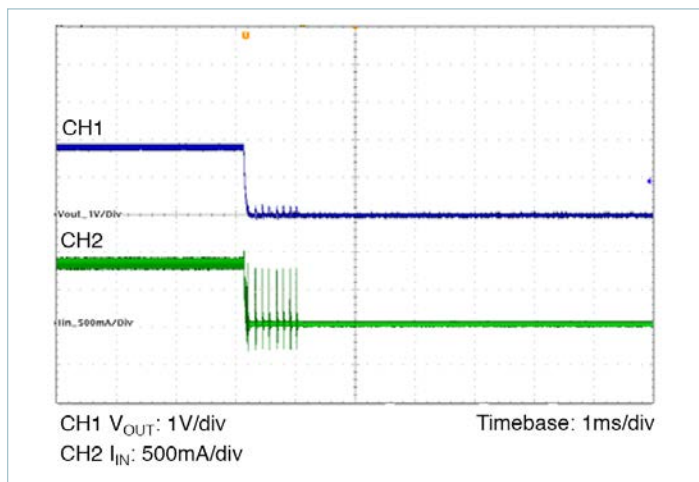

Figure 8 — Short Circuit Test

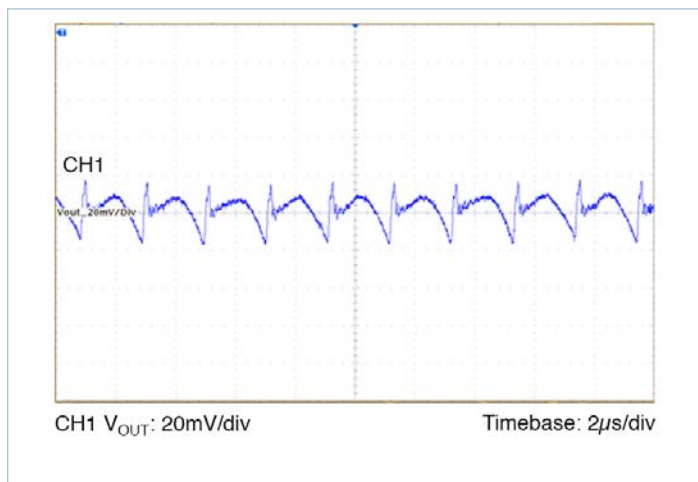

Figure 11 — Output Ripple 24V<sub>IN</sub>, 1.8V<sub>OUT</sub> at 10A

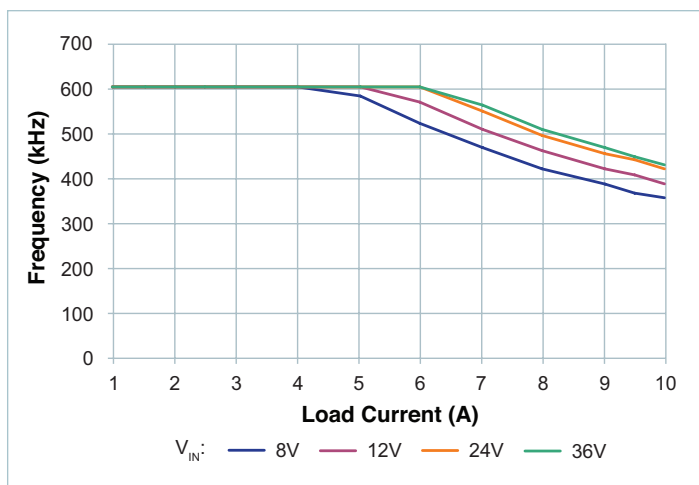

Figure 9 — Switching Frequency vs. Load Current

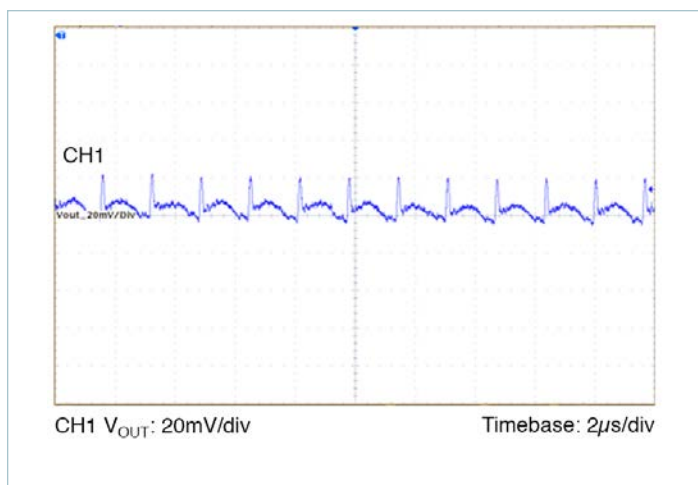

Figure 12 — Output Ripple 24V<sub>IN</sub>, 1.8V<sub>OUT</sub> at 5A

PI3312-x0-LGIZ (2.5V<sub>OUT</sub>) Electrical Characteristics

Unless otherwise specified:  $-40^{\circ}\text{C} < T_J < 125^{\circ}\text{C}$ ,  $V_{IN} = 24\text{V}$ ,  $L1 = 200\text{nH}$  <sup>[1]</sup>

Parameter	Symbol	Conditions	Min	Typ	Max	Unit
<b>Input Specifications</b>						
Input Voltage	$V_{IN\_DC}$	[7]	8	24	36	V
Input Current	$I_{IN\_DC}$	$V_{IN} = 24\text{V}$ , $T_C = 25^{\circ}\text{C}$ , $I_{OUT} = 10\text{A}$		1.14		A
Input Current At Output Short (fault condition duty cycle)	$I_{IN\_Short}$	[2]			20	mA
Input Quiescent Current	$I_{Q\_VIN}$	Disabled		2.0		mA
		Enabled (no load)		2.5		mA
Input Voltage Slew Rate	$V_{IN\_SR}$				1	V/ $\mu\text{s}$
<b>Output Specifications</b>						
Output Voltage Total Regulation	$V_{OUT\_DC}$	[2]	2.465	2.500	2.535	V
Output Voltage Trim Range	$V_{OUT\_DC}$	[3] [7]	2.0	2.5	3.1	V
Line Regulation	$\Delta V_{OUT} (\Delta V_{IN})$	@25 $^{\circ}\text{C}$ , $8\text{V} < V_{IN} < 36\text{V}$		0.10		%
Load Regulation	$\Delta V_{OUT} (\Delta I_{OUT})$	@25 $^{\circ}\text{C}$ , $0.5\text{A} < I_{OUT} < 10\text{A}$		0.10		%
Output Voltage Ripple	$V_{OUT\_AC}$	$I_{OUT} = 5\text{A}$ , $C_{OUT} = 4 \times 100\mu\text{F}$ , 20MHz BW <sup>[4]</sup>		28		mVp-p
Continuous Output Current Range	$I_{OUT\_DC}$	[5] [7]			10	A
Current Limit	$I_{OUT\_CL}$			12		A
<b>Protection</b>						
$V_{IN}$ UVLO Start Threshold	$V_{UVLO\_START}$		7.10	7.60	8.00	V
$V_{IN}$ UVLO Stop Threshold	$V_{UVLO\_STOP}$		6.80	7.25	7.60	V
$V_{IN}$ UVLO Hysteresis	$V_{UVLO\_HYS}$			0.33		V
$V_{IN}$ OVLO Start Threshold	$V_{OVLO\_START}$		36.1			V
$V_{IN}$ OVLO Stop Threshold	$V_{OVLO\_STOP}$		37.0	38.4		V
$V_{IN}$ OVLO Hysteresis	$V_{OVLO\_HYS}$			0.77		V
$V_{IN}$ UVLO/OVLO Response Time	$t_f$			500		ns
Output Overvoltage Protection	$V_{OVP}$	Above $V_{OUT}$		20		%
Overtemperature Fault Threshold	$T_{OTP}$		130	135	140	$^{\circ}\text{C}$
Overtemperature Restart Hysteresis	$T_{OTP\_HYS}$			30		$^{\circ}\text{C}$

<sup>[1]</sup> All parameters reflect regulator and inductor system performance. Measurements were made using a standard PI33xx-x0 evaluation board with 3x4" dimensions and 4 layer, 2oz copper. Refer to inductor pairing table within Application Description section for specific inductor manufacturer and value.

<sup>[2]</sup> Regulator is assured to meet performance specifications by design, test correlation, characterization, and/or statistical process control.

<sup>[3]</sup> Output current capability may be limited and other performance may vary from electrical characteristics when switching frequency or  $V_{OUT}$  is modified.

<sup>[4]</sup> Refer to Output Ripple plots.

<sup>[5]</sup> Refer to Load Current vs. Ambient Temperature curves.

<sup>[6]</sup> Refer to Switching Frequency vs. Load current curves.

<sup>[7]</sup> Minimum 5V between  $V_{IN}$ - $V_{OUT}$  must be maintained or a minimum load of 1mA required.

PI3312-x0-LGIZ (2.5V<sub>OUT</sub>) Electrical Characteristics (Cont.)

Unless otherwise specified: -40°C < T<sub>J</sub> < 125°C, V<sub>IN</sub> = 24V, L1 = 200nH <sup>[1]</sup>

Parameter	Symbol	Conditions	Min	Typ	Max	Unit
<b>Timing</b>						
Switching Frequency	f <sub>S</sub>	[6]		500		kHz
Fault Restart Delay	t <sub>FR_DLY</sub>			30		ms
<b>Sync In (SYNCI)</b>						
Synchronization Frequency Range	Δf <sub>SYNCI</sub>	Relative to set switching frequency [3]	50		110	%
SYNCI Threshold	V <sub>SYNCI</sub>			2.5		V
SYNCI Input Impedance	Z <sub>SYNCI</sub>			100		kΩ
<b>Sync Out (SYNCO)</b>						
SYNCO High	V <sub>SYNCO_HI</sub>	Source 1mA	4.5			V
SYNCO Low	V <sub>SYNCO_LO</sub>	Sink 1mA			0.5	V
SYNCO Rise Time	t <sub>SYNCO_RT</sub>	20pF load		10		ns
SYNCO Fall Time	t <sub>SYNCO_FT</sub>	20pF load		10		ns
<b>Soft Start And Tracking</b>						
TRK Active Input Range	V <sub>TRK</sub>	Internal reference tracking range	0		1.04	V
TRK Max Output Voltage				1.2		V
TRK Disable Threshold	V <sub>TRK_OV</sub>		20	40	60	mV
Charge Current (Soft – Start)	I <sub>TRK</sub>		70	50	30	μA
Discharge Current (Fault)	I <sub>TRK_DIS</sub>	V <sub>TRK</sub> = 0.5V		6.8		mA
Soft-Start Time	t <sub>SS</sub>	C <sub>TRK</sub> = 0μF		2.2		ms
<b>Enable</b>						
High Threshold	V <sub>EN_HI</sub>		0.9	1	1.1	V
Low Threshold	V <sub>EN_LO</sub>		0.7	0.8	0.9	V
Threshold Hysteresis	V <sub>EN_HYS</sub>		100	200	300	mV
Enable Pull-Up Voltage (Floating)	V <sub>EN_PU</sub>	With positive logic EN polarity		2		V
Enable Pull-Down Voltage (Floating)	V <sub>EN_PD</sub>	With negative logic EN polarity		0		V
Source Current	I <sub>EN_SO</sub>	With positive logic EN polarity		50		μA
Sink Current	I <sub>EN_SK</sub>	With negative logic EN polarity		50		μA

[1] All parameters reflect regulator and inductor system performance. Measurements were made using a standard PI33xx-x0 evaluation board with 3x4" dimensions and 4 layer, 2oz copper. Refer to inductor pairing table within Application Description section for specific inductor manufacturer and value.

[2] Regulator is assured to meet performance specifications by design, test correlation, characterization, and/or statistical process control.

[3] Output current capability may be limited and other performance may vary from electrical characteristics when switching frequency or V<sub>OUT</sub> is modified.

[4] Refer to Output Ripple plots.

[5] Refer to Load Current vs. Ambient Temperature curves.

[6] Refer to Switching Frequency vs. Load current curves.

[7] Minimum 5V between V<sub>IN</sub>-V<sub>OUT</sub> must be maintained or a minimum load of 1mA required.

PI3312-x0-LGIZ (2.5V<sub>OUT</sub>) Electrical Characteristics (Cont.)

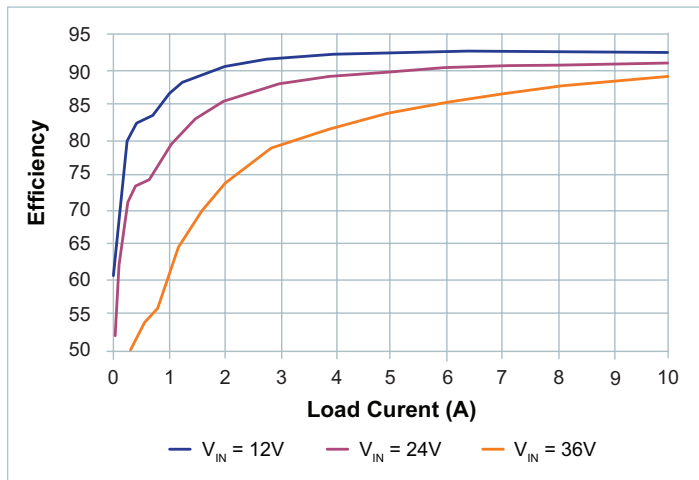

Figure 13 — Efficiency at 25°C

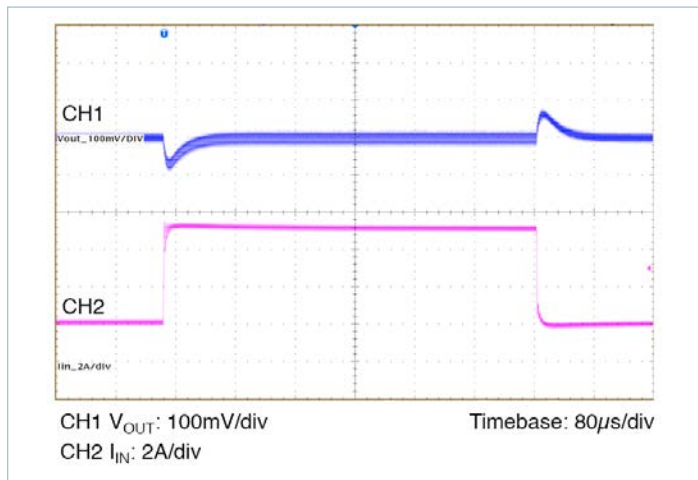

Figure 16 — Transient Response 5A to 10A, at 5A/μs

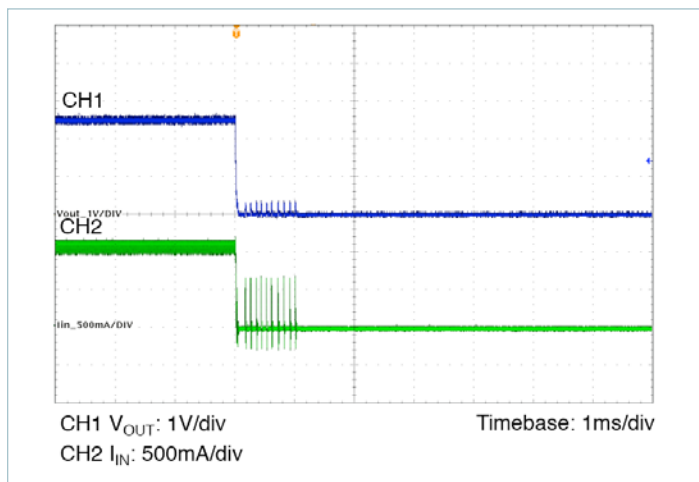

Figure 14 — Short Circuit Test

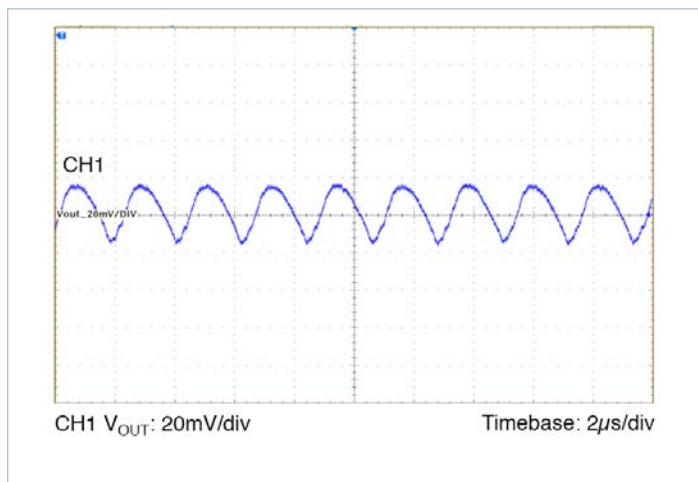

Figure 17 — Output Ripple 24V<sub>IN</sub>, 2.5V<sub>OUT</sub> at 10A

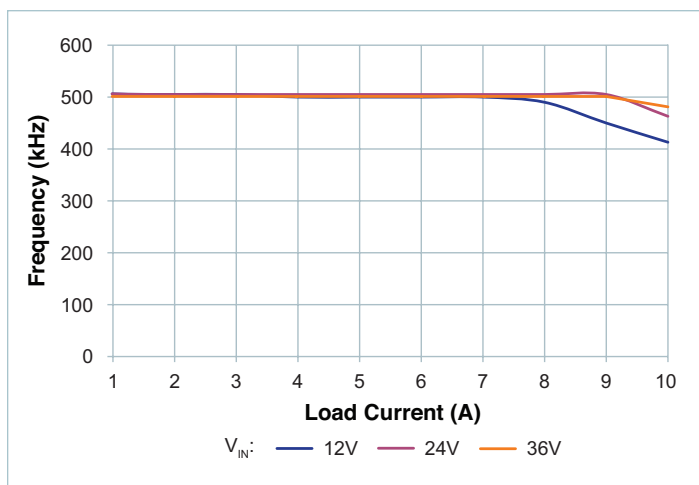

Figure 15 — Switching Frequency vs. Load Current

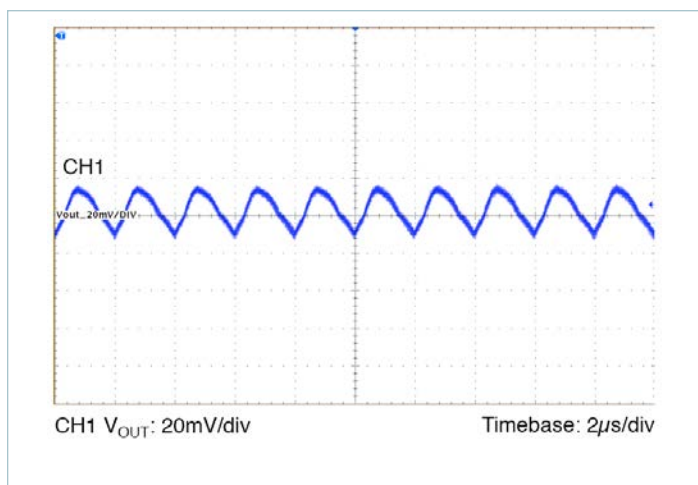

Figure 18 — Output Ripple 24V<sub>IN</sub>, 2.5V<sub>OUT</sub> at 5A

PI3312-x0-LGIZ (2.5V<sub>OUT</sub>) Electrical Characteristics (Cont.)

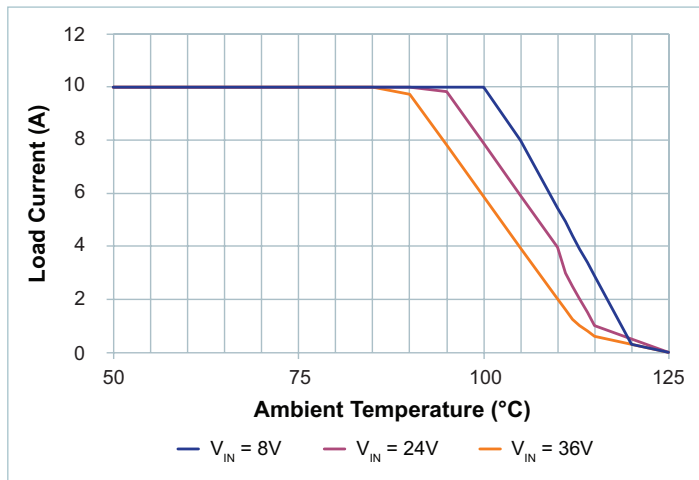

Figure 19 — Load Current vs. Ambient Temperature, 0LFM

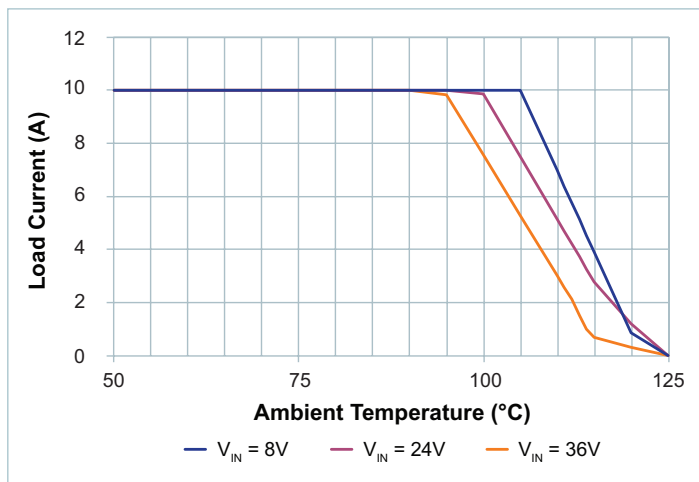

Figure 20 — Load Current vs. Ambient Temperature, 200LFM

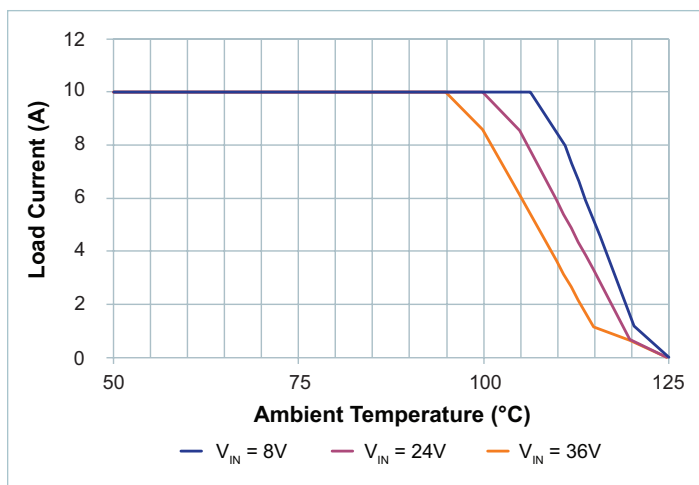

Figure 21 — Load Current vs. Ambient Temperature, 400LFM

PI3301-x0-LGIZ (3.3V<sub>OUT</sub>) Electrical Characteristics

Unless otherwise specified:  $-40^{\circ}\text{C} < T_J < 125^{\circ}\text{C}$ ,  $V_{IN} = 24\text{V}$ ,  $L1 = 200\text{nH}$  [1]

Parameter	Symbol	Conditions	Min	Typ	Max	Unit
<b>Input Specifications</b>						
Input Voltage	$V_{IN\_DC}$	[7]	8	24	36	V
Input Current	$I_{IN\_DC}$	$V_{IN} = 24\text{V}$ , $T_C = 25^{\circ}\text{C}$ , $I_{OUT} = 10\text{A}$		1.49		A
Input Current At Output Short (fault condition duty cycle)	$I_{IN\_Short}$	[2]			20	mA
Input Quiescent Current	$I_{Q\_VIN}$	Disabled		2.0		mA
		Enabled (no load)		2.5		mA
Input Voltage Slew Rate	$V_{IN\_SR}$				1	V/ $\mu\text{s}$
<b>Output Specifications</b>						
Output Voltage Total Regulation	$V_{OUT\_DC}$	[2]	3.25	3.30	3.36	V
Output Voltage Trim Range	$V_{OUT\_DC}$	[3][7]	2.3	3.3	4.1	V
Line Regulation	$\Delta V_{OUT} (\Delta V_{IN})$	@25 $^{\circ}\text{C}$ , $8\text{V} < V_{IN} < 36\text{V}$		0.10		%
Load Regulation	$\Delta V_{OUT} (\Delta I_{OUT})$	@25 $^{\circ}\text{C}$ , $0.5\text{A} < I_{OUT} < 10\text{A}$		0.10		%
Output Voltage Ripple	$V_{OUT\_AC}$	$I_{OUT} = 5\text{A}$ , $C_{OUT} = 4 \times 100\mu\text{F}$ , 20MHz BW [4]		37.5		mVp-p
Continuous Output Current Range	$I_{OUT\_DC}$	[5]			10	A
Current Limit	$I_{OUT\_CL}$			12		A
<b>Protection</b>						
$V_{IN}$ UVLO Start Threshold	$V_{UVLO\_START}$		7.10	7.60	8.00	V
$V_{IN}$ UVLO Stop Threshold	$V_{UVLO\_STOP}$		6.80	7.25	7.60	V
$V_{IN}$ UVLO Hysteresis	$V_{UVLO\_HYS}$			0.33		V
$V_{IN}$ OVLO Start Threshold	$V_{OVLO\_START}$		36.1			V
$V_{IN}$ OVLO Stop Threshold	$V_{OVLO\_STOP}$		37.0	38.4		V
$V_{IN}$ OVLO Hysteresis	$V_{OVLO\_HYS}$			0.77		V
$V_{IN}$ UVLO/OVLO Response Time	$t_f$			500		ns
Output Overvoltage Protection	$V_{OVP}$	Above $V_{OUT}$		20		%
Overtemperature Fault Threshold	$T_{OTP}$		130	135	140	$^{\circ}\text{C}$
Overtemperature Restart Hysteresis	$T_{OTP\_HYS}$			30		$^{\circ}\text{C}$

[1] All parameters reflect regulator and inductor system performance. Measurements were made using a standard PI33xx-x0 evaluation board with 3x4" dimensions and 4 layer, 2oz copper. Refer to inductor pairing table within Application Description section for specific inductor manufacturer and value.

[2] Regulator is assured to meet performance specifications by design, test correlation, characterization, and/or statistical process control.

[3] Output current capability may be limited and other performance may vary from electrical characteristics when switching frequency or  $V_{OUT}$  is modified.

[4] Refer to Output Ripple plots.

[5] Refer to Load Current vs. Ambient Temperature curves.

[6] Refer to Switching Frequency vs. Load current curves.

[7] Minimum 5V between  $V_{IN}$ - $V_{OUT}$  must be maintained or a minimum load of 1mA required.



PI3301-x0-LGIZ (3.3V<sub>OUT</sub>) Electrical Characteristics (Cont.)

Unless otherwise specified: -40°C < T<sub>J</sub> < 125°C, V<sub>IN</sub> = 24V, L1 = 200nH<sup>[1]</sup>

Parameter	Symbol	Conditions	Min	Typ	Max	Unit
<b>Timing</b>						
Switching Frequency	f <sub>s</sub>	[6]		650		kHz
Fault Restart Delay	t <sub>FR_DLY</sub>			30		ms
<b>Sync In (SYNCI)</b>						
Synchronization Frequency Range	Δf <sub>SYNCI</sub>	Relative to set switching frequency <sup>[3]</sup>	50		110	%
SYNCI Threshold	V <sub>SYNCI</sub>			2.5		V
SYNCI Input Impedance	Z <sub>SYNCI</sub>			100		kΩ
<b>Sync Out (SYNCO)</b>						
SYNCO High	V <sub>SYNCO_HI</sub>	Source 1mA	4.5			V
SYNCO Low	V <sub>SYNCO_LO</sub>	Sink 1mA			0.5	V
SYNCO Rise Time	t <sub>SYNCO_RT</sub>	20pF load		10		ns
SYNCO Fall Time	t <sub>SYNCO_FT</sub>	20pF load		10		ns
<b>Soft Start And Tracking</b>						
TRK Active Input Range	V <sub>TRK</sub>	Internal reference tracking range	0		1.04	V
TRK Max Output Voltage				1.2		V
TRK Disable Threshold	V <sub>TRK_OV</sub>		20	40	60	mV
Charge Current (Soft – Start)	I <sub>TRK</sub>		70	50	30	μA
Discharge Current (Fault)	I <sub>TRK_DIS</sub>	V <sub>TRK</sub> = 0.5V		6.8		mA
Soft-Start Time	t <sub>SS</sub>	C <sub>TRK</sub> = 0μF		2.2		ms
<b>Enable</b>						
High Threshold	V <sub>EN_HI</sub>		0.9	1	1.1	V
Low Threshold	V <sub>EN_LO</sub>		0.7	0.8	0.9	V
Threshold Hysteresis	V <sub>EN_HYS</sub>		100	200	300	mV
Enable Pull-Up Voltage (Floating)	V <sub>EN_PU</sub>	With positive logic EN polarity		2		V
Enable Pull-Down Voltage (Floating)	V <sub>EN_PD</sub>	With negative logic EN polarity		0		V
Source Current	I <sub>EN_SO</sub>	With positive logic EN polarity		50		μA
Sink Current	I <sub>EN_SK</sub>	With negative logic EN polarity		50		μA

[1] All parameters reflect regulator and inductor system performance. Measurements were made using a standard PI33xx-x0 evaluation board with 3x4" dimensions and 4 layer, 2oz copper. Refer to inductor pairing table within Application Description section for specific inductor manufacturer and value.

[2] Regulator is assured to meet performance specifications by design, test correlation, characterization, and/or statistical process control.

[3] Output current capability may be limited and other performance may vary from electrical characteristics when switching frequency or V<sub>OUT</sub> is modified.

[4] Refer to Output Ripple plots.

[5] Refer to Load Current vs. Ambient Temperature curves.

[6] Refer to Switching Frequency vs. Load current curves.

[7] Minimum 5V between V<sub>IN</sub>-V<sub>OUT</sub> must be maintained or a minimum load of 1mA required.

PI3301-x0-LGIZ (3.3V<sub>OUT</sub>) Electrical Characteristics (Cont.)

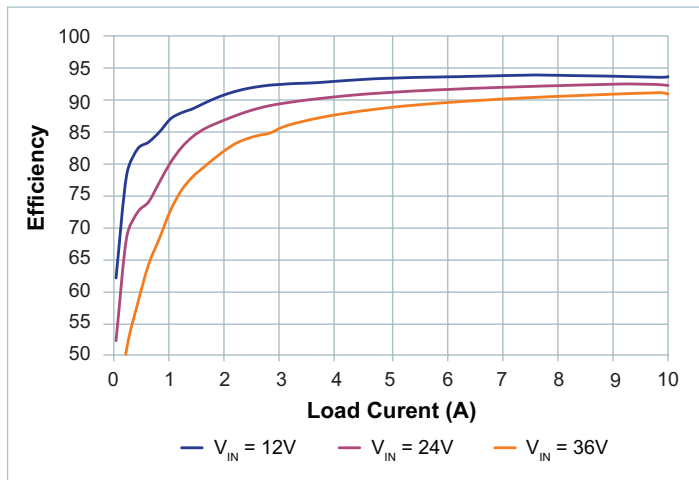

Figure 22 — Efficiency at 25°C

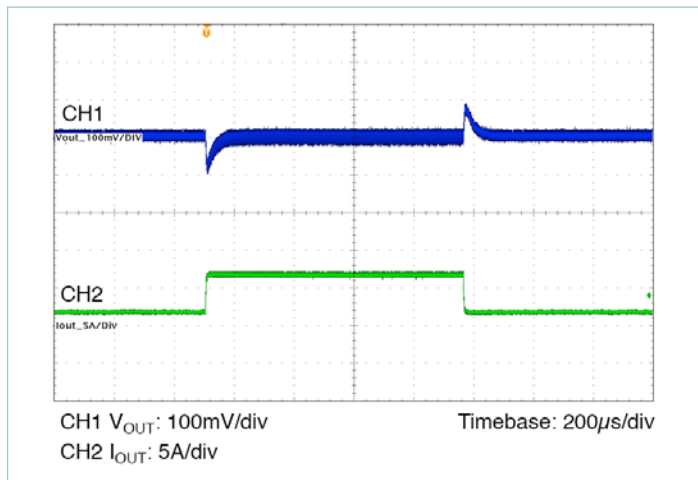

Figure 25 — Transient Response 2A to 7A, at 5A/μs

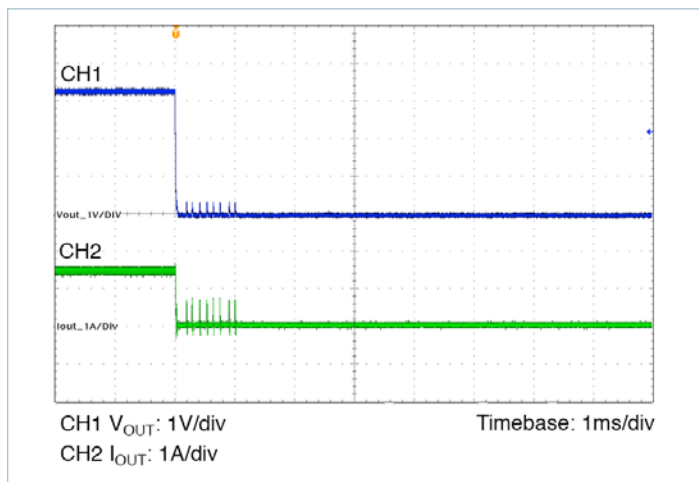

Figure 23 — Short Circuit Test

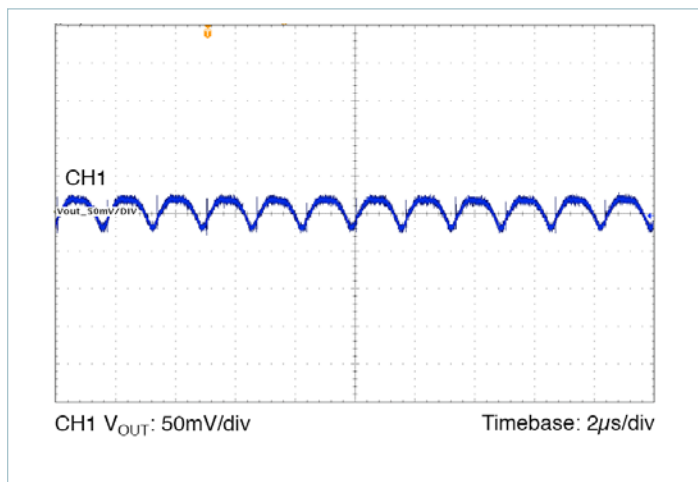

Figure 26 — Output Ripple 24V<sub>IN</sub>, 3.3V<sub>OUT</sub> at 10A

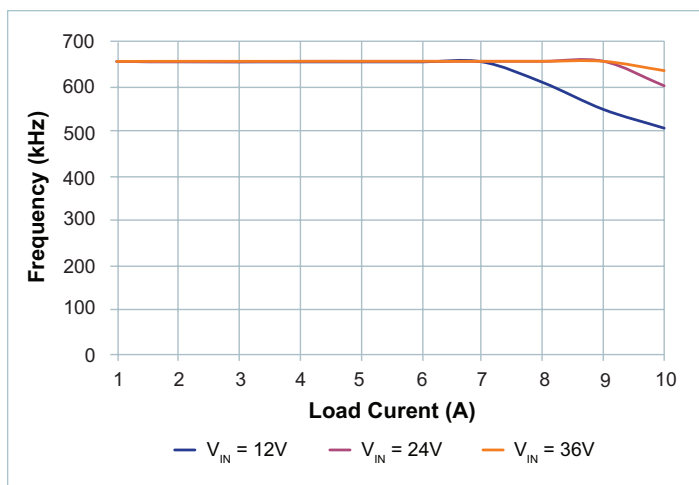

Figure 24 — Switching Frequency vs. Load Current

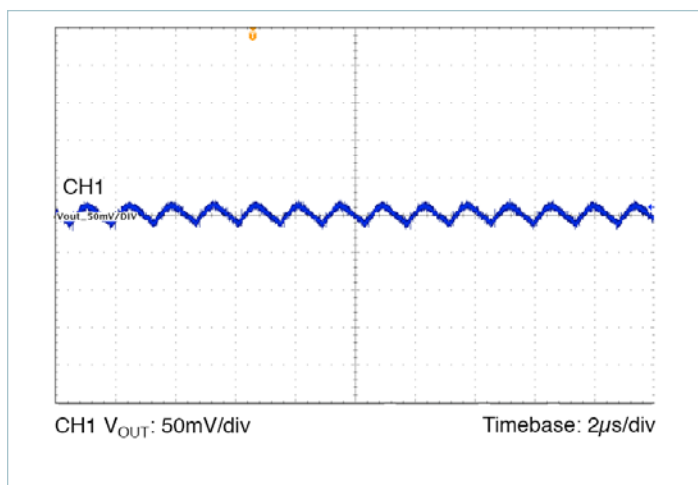

Figure 27 — Output Ripple 24V<sub>IN</sub>, 3.3V<sub>OUT</sub> at 5A

PI3301-x0-LGIZ (3.3V<sub>OUT</sub>) Electrical Characteristics (Cont.)

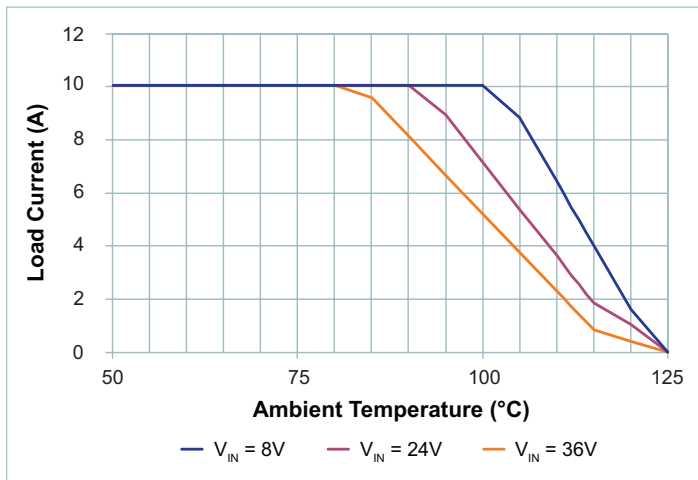

Figure 28 — Load Current vs. Ambient Temperature, 0LFM

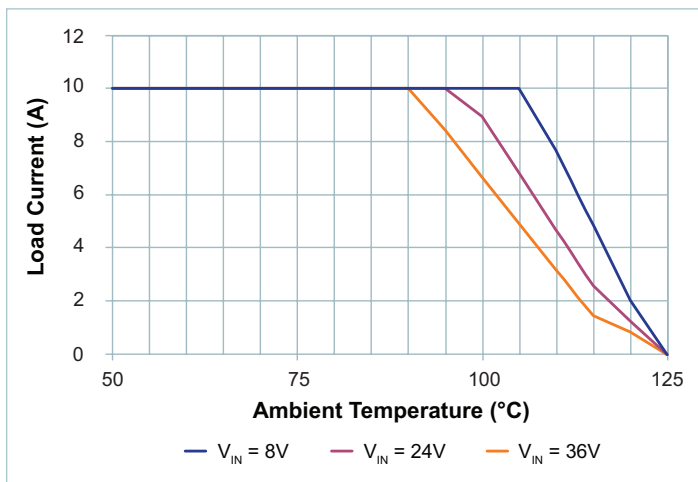

Figure 29 — Load Current vs. Ambient Temperature, 200LFM

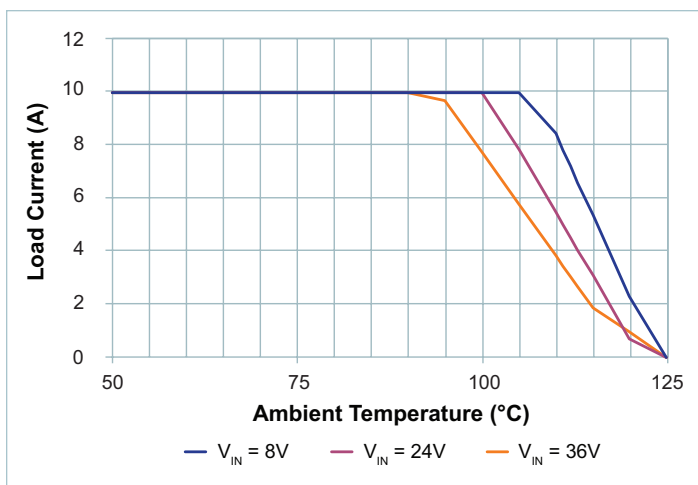

Figure 30 — Load Current vs. Ambient Temperature, 400LFM

PI3302-x0-LGIZ (5.0V<sub>OUT</sub>) Electrical Characteristics

Unless otherwise specified:  $-40^{\circ}\text{C} < T_J < 125^{\circ}\text{C}$ ,  $V_{IN} = 24\text{V}$ ,  $L1 = 200\text{nH}$  <sup>[1]</sup>

Parameter	Symbol	Conditions	Min	Typ	Max	Unit
<b>Input Specifications</b>						
Input Voltage	$V_{IN\_DC}$	[7]	8	24	36	V
Input Current	$I_{IN\_DC}$	$V_{IN} = 24\text{V}$ , $T_C = 25^{\circ}\text{C}$ , $I_{OUT} = 10\text{A}$		2.23		A
Input Current At Output Short (fault condition duty cycle)	$I_{IN\_Short}$	[2]			20	mA
Input Quiescent Current	$I_{Q\_VIN}$	Disabled		2.0		mA
		Enabled (no load)		2.5		mA
Input Voltage Slew Rate	$V_{IN\_SR}$				1	V/ $\mu\text{s}$
<b>Output Specifications</b>						
Output Voltage Total Regulation	$V_{OUT\_DC}$	[2]	4.93	5.00	5.07	V
Output Voltage Trim Range	$V_{OUT\_DC}$	[3] [7]	3.3		6.5	V
Line Regulation	$\Delta V_{OUT} (\Delta V_{IN})$	@25 $^{\circ}\text{C}$ , $8\text{V} < V_{IN} < 36\text{V}$		0.10		%
Load Regulation	$\Delta V_{OUT} (\Delta I_{OUT})$	@25 $^{\circ}\text{C}$ , $0.5\text{A} < I_{OUT} < 10\text{A}$		0.10		%
Output Voltage Ripple	$V_{OUT\_AC}$	$I_{OUT} = 5\text{A}$ , $C_{OUT} = 4 \times 47\mu\text{F}$ , 20MHz BW <sup>[4]</sup>		30		mVp-p
Continuous Output Current Range	$I_{OUT\_DC}$	[5] [7]			10	A
Current Limit	$I_{OUT\_CL}$			12		A
<b>Protection</b>						
$V_{IN}$ UVLO Start Threshold	$V_{UVLO\_START}$		7.10	7.60	8.00	V
$V_{IN}$ UVLO Stop Threshold	$V_{UVLO\_STOP}$		6.80	7.25	7.60	V
$V_{IN}$ UVLO Hysteresis	$V_{UVLO\_HYS}$			0.33		V
$V_{IN}$ OVLO Start Threshold	$V_{OVLO\_START}$		36.1			V
$V_{IN}$ OVLO Stop Threshold	$V_{OVLO\_STOP}$		37.0	38.4		V
$V_{IN}$ OVLO Hysteresis	$V_{OVLO\_HYS}$			0.77		V
$V_{IN}$ UVLO/OVLO Response Time	$t_f$			500		ns
Output Overvoltage Protection	$V_{OVP}$	Above $V_{OUT}$		20		%
Overtemperature Fault Threshold	$T_{OTP}$		130	135	140	$^{\circ}\text{C}$
Overtemperature Restart Hysteresis	$T_{OTP\_HYS}$			30		$^{\circ}\text{C}$

<sup>[1]</sup> All parameters reflect regulator and inductor system performance. Measurements were made using a standard PI33xx-x0 evaluation board with 3x4" dimensions and 4 layer, 2oz copper. Refer to inductor pairing table within Application Description section for specific inductor manufacturer and value.

<sup>[2]</sup> Regulator is assured to meet performance specifications by design, test correlation, characterization, and/or statistical process control.

<sup>[3]</sup> Output current capability may be limited and other performance may vary from electrical characteristics when switching frequency or  $V_{OUT}$  is modified.

<sup>[4]</sup> Refer to Output Ripple plots.

<sup>[5]</sup> Refer to Load Current vs. Ambient Temperature curves.

<sup>[6]</sup> Refer to Switching Frequency vs. Load current curves.

<sup>[7]</sup> Minimum 5V between  $V_{IN}$ - $V_{OUT}$  must be maintained or a minimum load of 1mA required.

PI3302-x0-LGIZ (5.0V<sub>OUT</sub>) Electrical Characteristics (Cont.)

Unless otherwise specified: -40°C < T<sub>J</sub> < 125°C, V<sub>IN</sub> = 24V, L1 = 200nH<sup>[1]</sup>

Parameter	Symbol	Conditions	Min	Typ	Max	Unit
<b>Timing</b>						
Switching Frequency	f <sub>S</sub>	[6]		1.0		MHz
Fault Restart Delay	t <sub>FR_DLY</sub>			30		ms
<b>Sync In (SYNCI)</b>						
Synchronization Frequency Range	Δf <sub>SYNCI</sub>	Relative to set switching frequency <sup>[3]</sup>	50		110	%
SYNCI Threshold	V <sub>SYNCI</sub>			2.5		V
SYNCI Input Impedance	Z <sub>SYNCI</sub>			100		kΩ
<b>Sync Out (SYNCO)</b>						
SYNCO High	V <sub>SYNCO_HI</sub>	Source 1mA	4.5			V
SYNCO Low	V <sub>SYNCO_LO</sub>	Sink 1mA			0.5	V
SYNCO Rise Time	t <sub>SYNCO_RT</sub>	20pF load		10		ns
SYNCO Fall Time	t <sub>SYNCO_FT</sub>	20pF load		10		ns
<b>Soft Start And Tracking</b>						
TRK Active Input Range	V <sub>TRK</sub>		0		1.04	V
TRK Max Output Voltage				1.2		V
TRK Disable Threshold	V <sub>TRK_OV</sub>		20	40	60	mV
Charge Current (Soft – Start)	I <sub>TRK</sub>		70	50	30	μA
Discharge Current (Fault)	I <sub>TRK_DIS</sub>	V <sub>TRK</sub> = 0.5V		6.8		mA
Soft-Start Time	t <sub>SS</sub>	C <sub>TRK</sub> = 0μF		2.2		ms
<b>Enable</b>						
High Threshold	V <sub>EN_HI</sub>		0.9	1	1.1	V
Low Threshold	V <sub>EN_LO</sub>		0.7	0.8	0.9	V
Threshold Hysteresis	V <sub>EN_HYS</sub>		100	200	300	mV
Enable Pull-Up Voltage (Floating)	V <sub>EN_PU</sub>	With positive logic EN polarity		2		V
Enable Pull-Down Voltage (Floating)	V <sub>EN_PD</sub>	With negative logic EN polarity		0		V
Source Current	I <sub>EN_SO</sub>	With positive logic EN polarity		50		μA
Sink Current	I <sub>EN_SK</sub>	With negative logic EN polarity		50		μA

<sup>[1]</sup> All parameters reflect regulator and inductor system performance. Measurements were made using a standard PI33xx-x0 evaluation board with 3x4" dimensions and 4 layer, 2oz copper. Refer to inductor pairing table within Application Description section for specific inductor manufacturer and value.

<sup>[2]</sup> Regulator is assured to meet performance specifications by design, test correlation, characterization, and/or statistical process control.

<sup>[3]</sup> Output current capability may be limited and other performance may vary from electrical characteristics when switching frequency or V<sub>OUT</sub> is modified.

<sup>[4]</sup> Refer to Output Ripple plots.

<sup>[5]</sup> Refer to Load Current vs. Ambient Temperature curves.

<sup>[6]</sup> Refer to Switching Frequency vs. Load current curves.

<sup>[7]</sup> Minimum 5V between V<sub>IN</sub>-V<sub>OUT</sub> must be maintained or a minimum load of 1mA required.

PI3302-x0-LGIZ (5.0V<sub>OUT</sub>) Electrical Characteristics (Cont.)

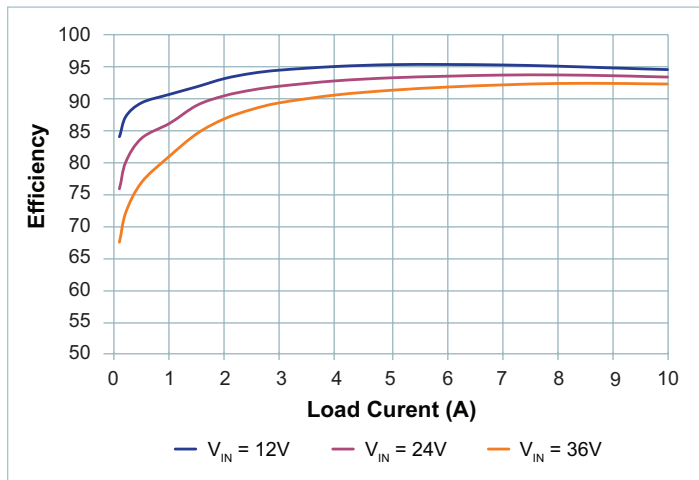

Figure 31 — Efficiency at 25°C

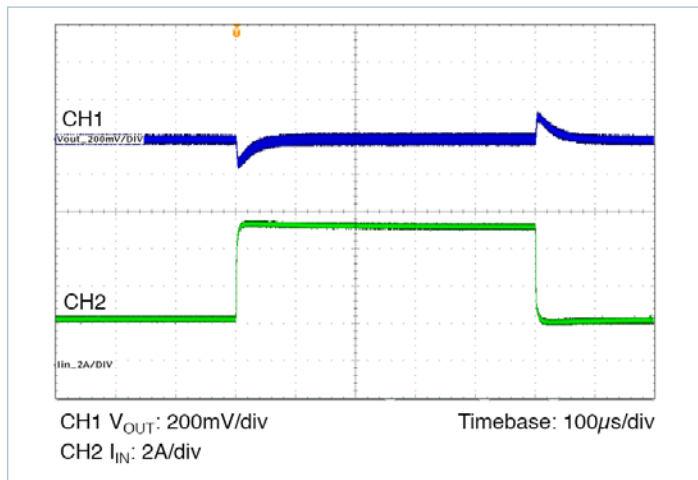

Figure 34 — Transient Response 2A to 7A, at 5A/μs

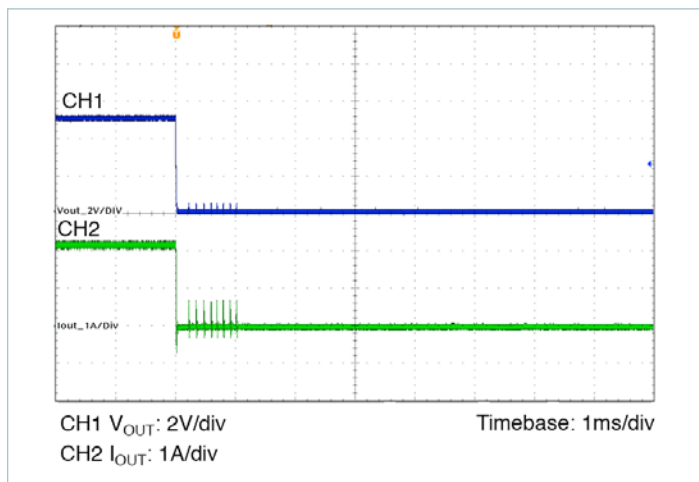

Figure 32 — Short Circuit Test

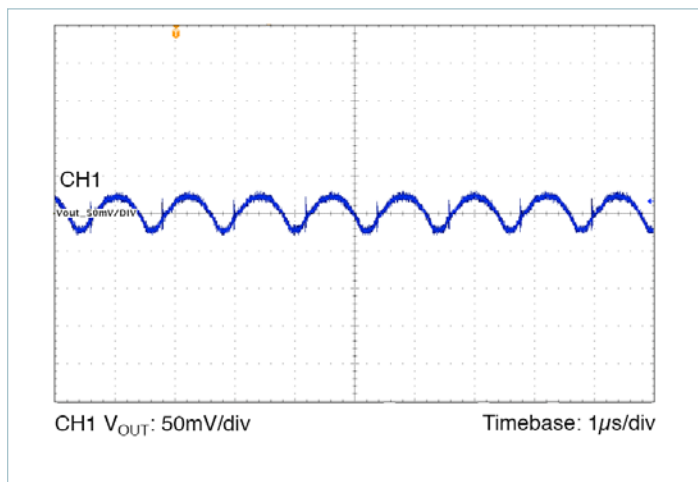

Figure 35 — Output Ripple 24VIN, 5.0VOUT at 10A

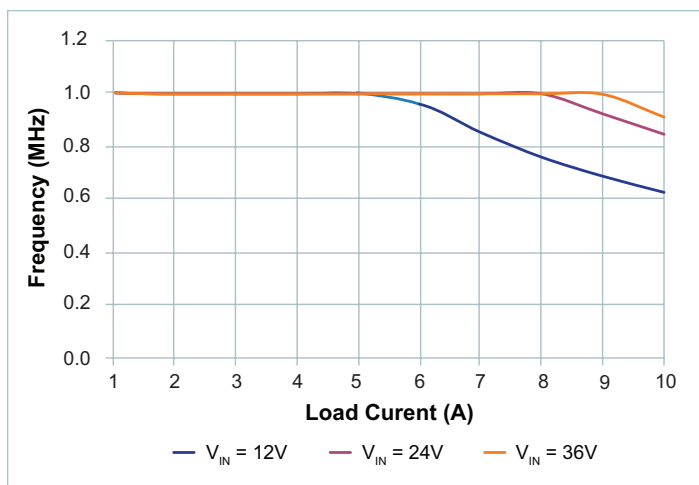

Figure 33 — Switching Frequency vs. Load Current

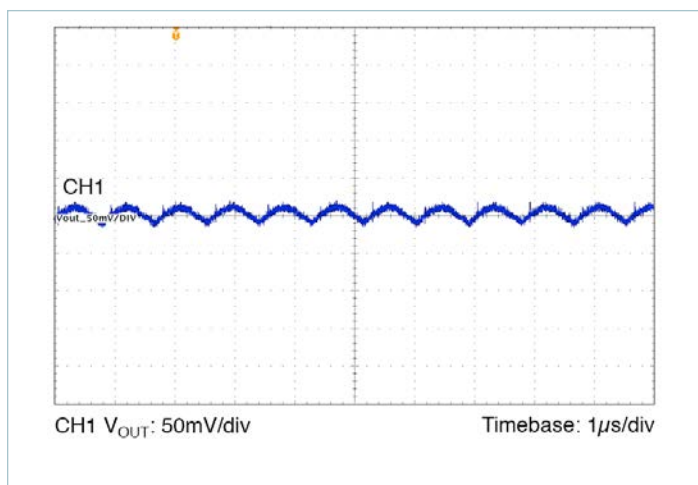

Figure 36 — Output Ripple 24VIN, 5.0VOUT at 5A

PI3302-x0-LGIZ (5.0V<sub>OUT</sub>) Electrical Characteristics (Cont.)

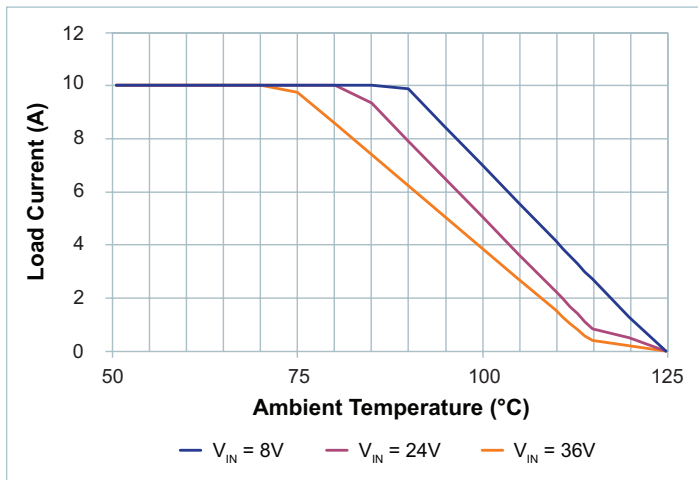

Figure 37 — Load Current vs. Ambient Temperature, 0LFM

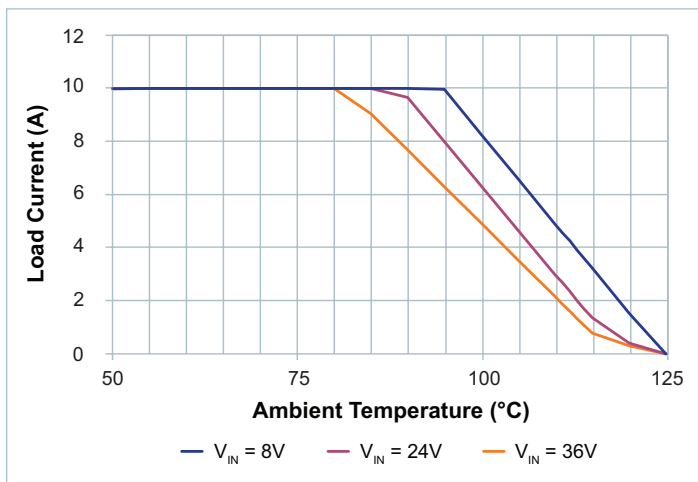

Figure 38 — Load Current vs. Ambient Temperature, 200LFM

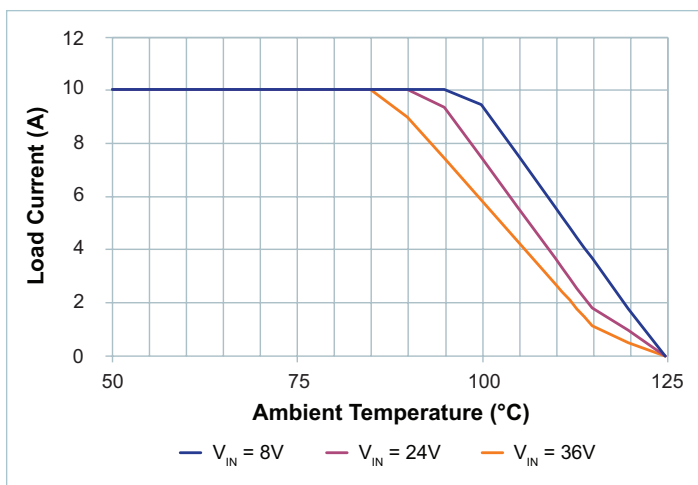

Figure 39 — Load Current vs. Ambient Temperature, 400LFM

PI3303-x0-LGIZ (12.0V<sub>OUT</sub>) Electrical Characteristics

Unless otherwise specified: -40°C < T<sub>J</sub> < 125°C, V<sub>IN</sub> = 24V, L1 = 230nH <sup>[1]</sup>

Parameter	Symbol	Conditions	Min	Typ	Max	Unit
<b>Input Specifications</b>						
Input Voltage	V <sub>IN_DC</sub>	[7]	17.4	24	36	V
Input Current	I <sub>IN_DC</sub>	V <sub>IN</sub> = 24V, T <sub>C</sub> = 25°C, I <sub>OUT</sub> = 8A		4.15		A
Input Current At Output Short (fault condition duty cycle)	I <sub>IN_Short</sub>	[2]			20	mA
Input Quiescent Current	I <sub>Q_VIN</sub>	Disabled		2.0		mA
		Enabled (no load)		2.5		mA
Input Voltage Slew Rate	V <sub>IN_SR</sub>				1	V/μs
<b>Output Specifications</b>						
Output Voltage Total Regulation	V <sub>OUT_DC</sub>	[2]	11.82	12.0	12.18	V
Output Voltage Trim Range	V <sub>OUT_DC</sub>	[3][7]	6.5	12	13.0	V
Line Regulation	ΔV <sub>OUT</sub> (ΔV <sub>IN</sub> )	@25°C, 8V < V <sub>IN</sub> < 36V		0.10		%
Load Regulation	ΔV <sub>OUT</sub> (ΔI <sub>OUT</sub> )	@25°C, 0.5A < I <sub>OUT</sub> < 8A		0.10		%
Output Voltage Ripple	V <sub>OUT_AC</sub>	I <sub>OUT</sub> = 4A, C <sub>OUT</sub> = 4 x 22μF, 20MHz BW <sup>[4]</sup>		60		mVp-p
Continuous Output Current Range	I <sub>OUT_DC</sub>	[5]			8	A
Current Limit	I <sub>OUT_CL</sub>			9		A
<b>Protection</b>						
V <sub>IN</sub> UVLO Start Threshold	V <sub>UVLO_START</sub>		15.80	16.60	17.40	V
V <sub>IN</sub> UVLO Stop Threshold	V <sub>UVLO_STOP</sub>		15.00	15.80	16.60	V
V <sub>IN</sub> UVLO Hysteresis	V <sub>UVLO_HYS</sub>			0.77		V
V <sub>IN</sub> OVLO Start Threshold	V <sub>OVLO_START</sub>		36.1			V
V <sub>IN</sub> OVLO Stop Threshold	V <sub>OVLO_STOP</sub>		37.0	38.4		V
V <sub>IN</sub> OVLO Hysteresis	V <sub>OVLO_HYS</sub>			0.77		V
V <sub>IN</sub> UVLO/OVLO Response Time	t <sub>f</sub>			500		ns
Output Overvoltage Protection	V <sub>OVP</sub>	Above V <sub>OUT</sub>		20		%
Overtemperature Fault Threshold	T <sub>OTP</sub>		130	135	140	°C
Overtemperature Restart Hysteresis	T <sub>OTP_HYS</sub>			30		°C

<sup>[1]</sup> All parameters reflect regulator and inductor system performance. Measurements were made using a standard PI33xx-x0 evaluation board with 3x4" dimensions and 4 layer, 2oz copper. Refer to inductor pairing table within Application Description section for specific inductor manufacturer and value.

<sup>[2]</sup> Regulator is assured to meet performance specifications by design, test correlation, characterization, and/or statistical process control.

<sup>[3]</sup> Output current capability may be limited and other performance may vary from electrical characteristics when switching frequency or V<sub>OUT</sub> is modified.

<sup>[4]</sup> Refer to Output Ripple plots.

<sup>[5]</sup> Refer to Load Current vs. Ambient Temperature curves.

<sup>[6]</sup> Refer to Switching Frequency vs. Load current curves.

<sup>[7]</sup> Minimum 5V between V<sub>IN</sub>-V<sub>OUT</sub> must be maintained or a minimum load of 1mA required.



PI3303-x0-LGIZ (12.0V<sub>OUT</sub>) Electrical Characteristics (Cont.)

Unless otherwise specified: -40°C < T<sub>J</sub> < 125°C, V<sub>IN</sub> = 24V, L1 = 230nH<sup>[1]</sup>

Parameter	Symbol	Conditions	Min	Typ	Max	Unit
<b>Timing</b>						
Switching Frequency	f <sub>S</sub>	[6]		1.4		MHz
Fault Restart Delay	t <sub>FR_DLY</sub>			30		ms
<b>Sync In (SYNCI)</b>						
Synchronization Frequency Range	Δf <sub>SYNCI</sub>	Relative to set switching frequency <sup>[3]</sup>	50		110	%
SYNCI Threshold	V <sub>SYNCI</sub>			2.5		V
SYNCI Input Impedance	Z <sub>SYNCI</sub>			100		kΩ
<b>Sync Out (SYNCO)</b>						
SYNCO High	V <sub>SYNCO_HI</sub>	Source 1mA	4.5			V
SYNCO Low	V <sub>SYNCO_LO</sub>	Sink 1mA			0.5	V
SYNCO Rise Time	t <sub>SYNCO_RT</sub>	20pF load		10		ns
SYNCO Fall Time	t <sub>SYNCO_FT</sub>	20pF load		10		ns
<b>Soft Start And Tracking</b>						
TRK Active Input Range	V <sub>TRK</sub>		0		1.04	V
TRK Max Output Voltage				1.2		V
TRK Disable Threshold	V <sub>TRK_OV</sub>		20	40	60	mV
Charge Current (Soft – Start)	I <sub>TRK</sub>		70	50	30	μA
Discharge Current (Fault)	I <sub>TRK_DIS</sub>	V <sub>TRK</sub> = 0.5V		6.8		mA
Soft-Start Time	t <sub>SS</sub>	C <sub>TRK</sub> = 0μF		2.2		ms
<b>Enable</b>						
High Threshold	V <sub>EN_HI</sub>		0.9	1	1.1	V
Low Threshold	V <sub>EN_LO</sub>		0.7	0.8	0.9	V
Threshold Hysteresis	V <sub>EN_HYS</sub>		100	200	300	mV
Enable Pull-Up Voltage (Floating)	V <sub>EN_PU</sub>	With positive logic EN polarity		2		V
Enable Pull-Down Voltage (Floating)	V <sub>EN_PD</sub>	With negative logic EN polarity		0		V
Source Current	I <sub>EN_SO</sub>	With positive logic EN polarity		50		μA
Sink Current	I <sub>EN_SK</sub>	With negative logic EN polarity		50		μA

<sup>[1]</sup> All parameters reflect regulator and inductor system performance. Measurements were made using a standard PI33xx-x0 evaluation board with 3x4" dimensions and 4 layer, 2oz copper. Refer to inductor pairing table within Application Description section for specific inductor manufacturer and value.

<sup>[2]</sup> Regulator is assured to meet performance specifications by design, test correlation, characterization, and/or statistical process control.

<sup>[3]</sup> Output current capability may be limited and other performance may vary from electrical characteristics when switching frequency or V<sub>OUT</sub> is modified.

<sup>[4]</sup> Refer to Output Ripple plots.

<sup>[5]</sup> Refer to Load Current vs. Ambient Temperature curves.

<sup>[6]</sup> Refer to Switching Frequency vs. Load current curves.

<sup>[7]</sup> Minimum 5V between V<sub>IN</sub>-V<sub>OUT</sub> must be maintained or a minimum load of 1mA required.

PI3303-x0-LGIZ (12.0V<sub>OUT</sub>) Electrical Characteristics (Cont.)

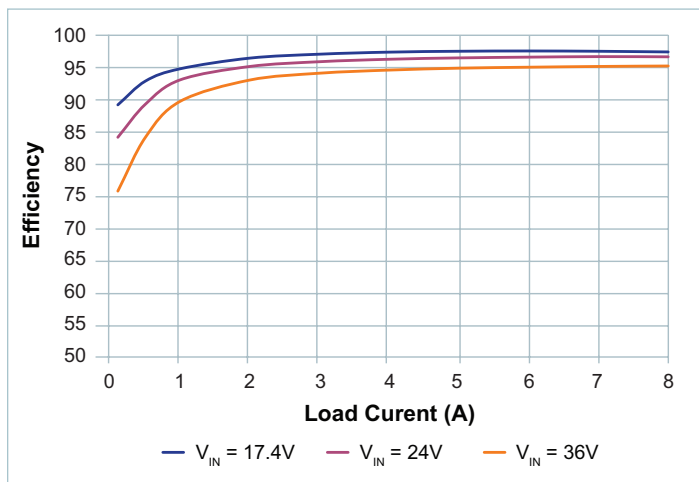

Figure 40 — Efficiency at 25°C

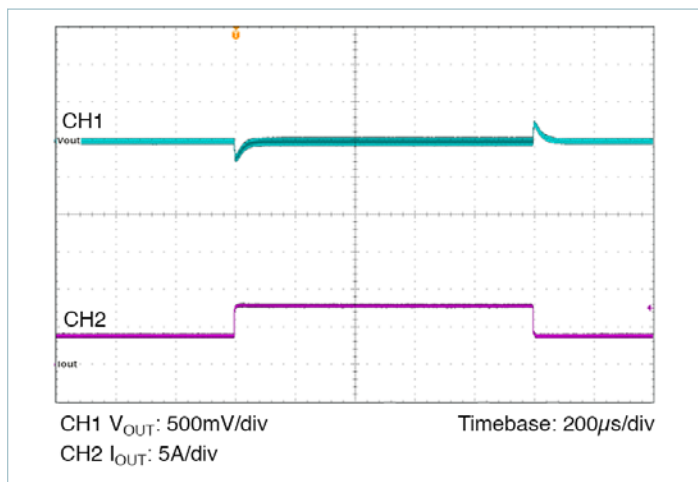

Figure 43 — Transient Response 4A to 8A, at 5A/μs

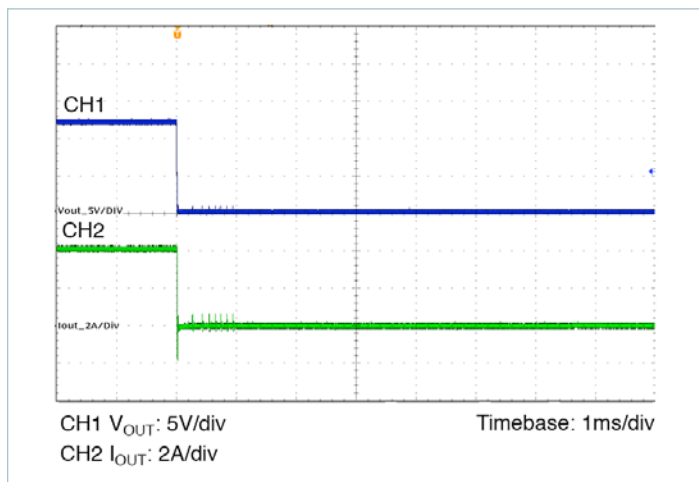

Figure 41 — Short Circuit Test

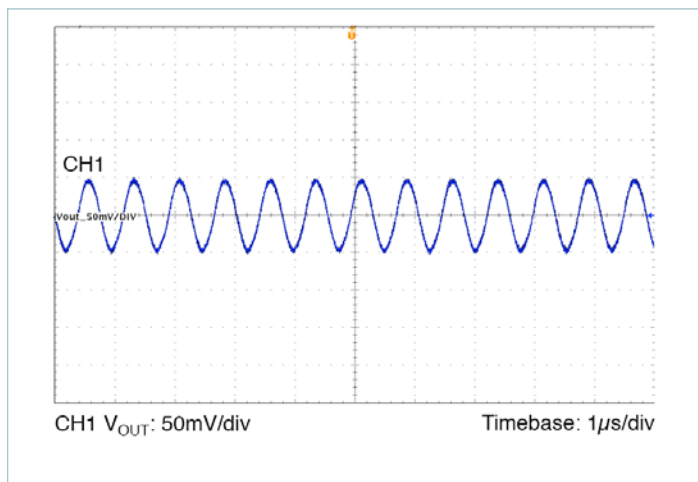

Figure 44 — Output Ripple 24V<sub>IN</sub>, 12.0V<sub>OUT</sub> at 8A

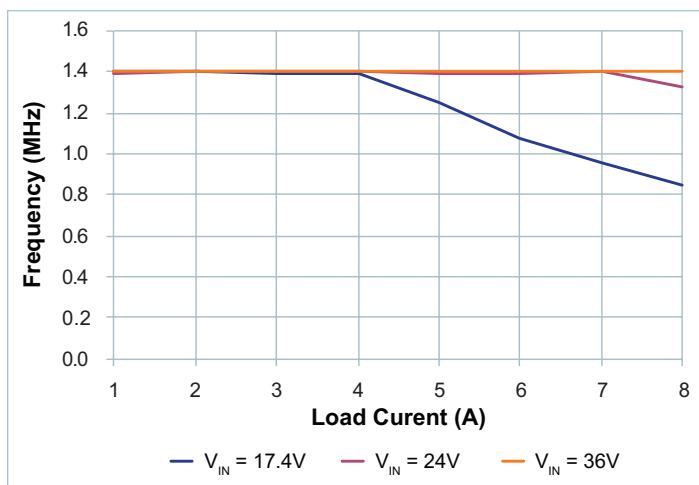

Figure 42 — Switching Frequency vs. Load Current

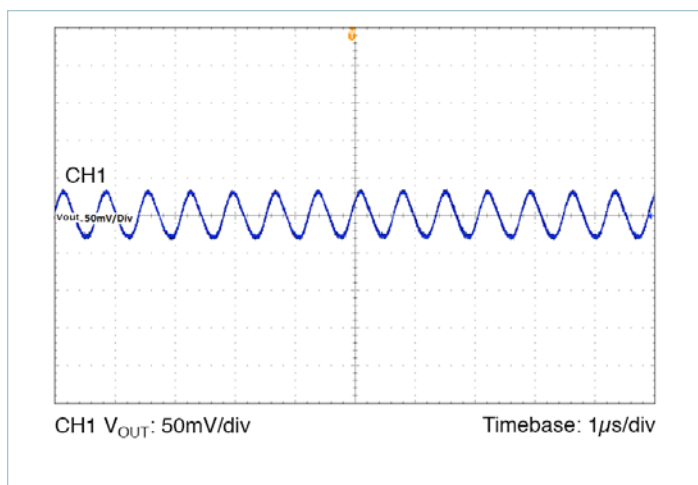

Figure 45 — Output Ripple 24V<sub>IN</sub>, 12.0V<sub>OUT</sub> at 4A

PI3303-x0-LGIZ (12.0V<sub>OUT</sub>) Electrical Characteristics (Cont.)

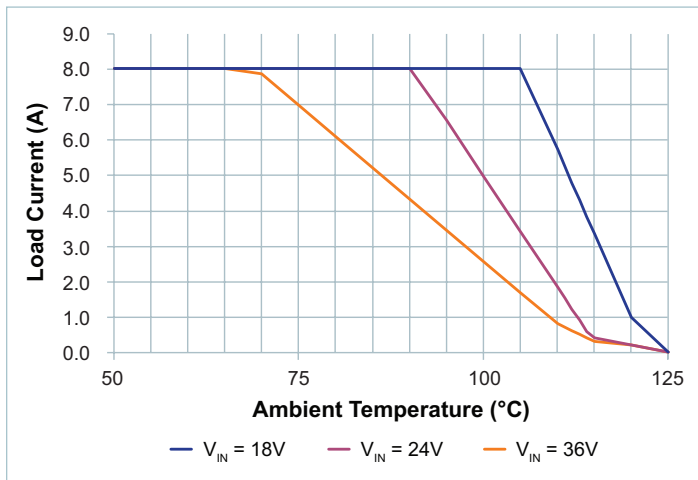

Figure 46 — Load Current vs. Ambient Temperature, 0LFM

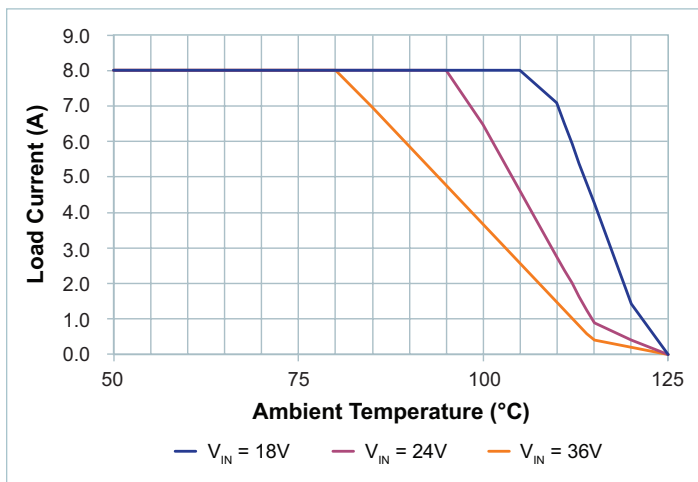

Figure 47 — Load Current vs. Ambient Temperature, 200LFM

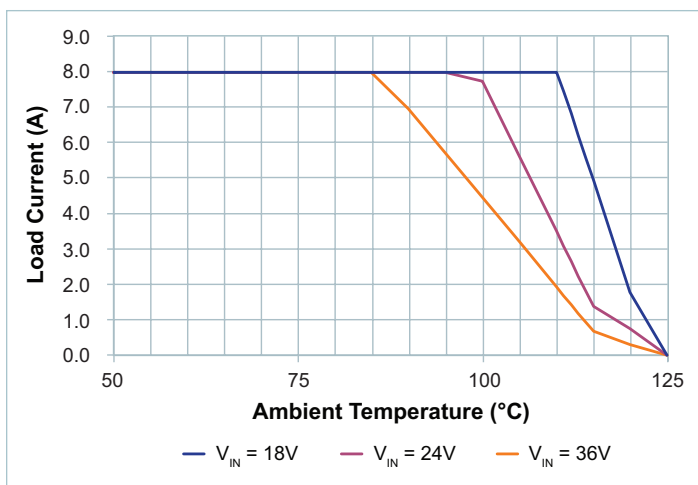

Figure 48 — Load Current vs. Ambient Temperature, 400LFM

PI3305-x0-LGIZ (15.0V<sub>OUT</sub>) Electrical Characteristics

Unless otherwise specified:  $-40^{\circ}\text{C} < T_J < 125^{\circ}\text{C}$ ,  $V_{IN} = 24\text{V}$ ,  $L_1 = 230\text{nH}$  [1]

Parameter	Symbol	Conditions	Min	Typ	Max	Unit
<b>Input Specifications</b>						
Input Voltage	$V_{IN\_DC}$	[7]	20.4	24	36	V
Input Current	$I_{IN\_DC}$	$V_{IN} = 24\text{V}$ , $T_C = 25^{\circ}\text{C}$ , $I_{OUT} = 8\text{A}$		5.15		A
Input Current At Output Short (fault condition duty cycle)	$I_{IN\_Short}$	[2]			20	mA
Input Quiescent Current	$I_{Q\_VIN}$	Disabled		2.0		mA
		Enabled (no load)		2.5		mA
Input Voltage Slew Rate	$V_{IN\_SR}$				1	V/ $\mu\text{s}$
<b>Output Specifications</b>						
Output Voltage Total Regulation	$V_{OUT\_DC}$	[2]	14.78	15.0	15.23	V
Output Voltage Trim Range	$V_{OUT\_DC}$	[3] [7]	10.0	15	16	V
Line Regulation	$\Delta V_{OUT} (\Delta V_{IN})$	@25 $^{\circ}\text{C}$ , $8\text{V} < V_{IN} < 36\text{V}$		0.1		%
Load Regulation	$\Delta V_{OUT} (\Delta I_{OUT})$	@25 $^{\circ}\text{C}$ , $0.5\text{A} < I_{OUT} < 8\text{A}$		0.1		%
Output Voltage Ripple	$V_{OUT\_AC}$	$I_{OUT} = 4\text{A}$ , $C_{OUT} = 4 \times 22\mu\text{F}$ , 20MHz BW [4]		60		mVp-p
Continuous Output Current Range	$I_{OUT\_DC}$	[5] [7]			8	A
Current Limit	$I_{OUT\_CL}$			9		A
<b>Protection</b>						
$V_{IN}$ UVLO Start Threshold	$V_{UVLO\_START}$		18.4	19.4	20.4	V
$V_{IN}$ UVLO Stop Threshold	$V_{UVLO\_STOP}$		17.4	18.4	19.4	V
$V_{IN}$ UVLO Hysteresis	$V_{UVLO\_HYS}$			0.90		V
$V_{IN}$ OVLO Start Threshold	$V_{OVLO\_START}$		36.1			V
$V_{IN}$ OVLO Stop Threshold	$V_{OVLO\_STOP}$		37.0	38.4		V
$V_{IN}$ OVLO Hysteresis	$V_{OVLO\_HYS}$			0.77		V
$V_{IN}$ UVLO/OVLO Response Time	$t_f$			500		ns
Output Overvoltage Protection	$V_{OVP}$	Above $V_{OUT}$		20		%
Overtemperature Fault Threshold	$T_{OTP}$		130	135	140	$^{\circ}\text{C}$
Overtemperature Restart Hysteresis	$T_{OTP\_HYS}$			30		$^{\circ}\text{C}$

[1] All parameters reflect regulator and inductor system performance. Measurements were made using a standard PI33xx-x0 evaluation board with 3x4" dimensions and 4 layer, 2oz copper. Refer to inductor pairing table within Application Description section for specific inductor manufacturer and value.

[2] Regulator is assured to meet performance specifications by design, test correlation, characterization, and/or statistical process control.

[3] Output current capability may be limited and other performance may vary from electrical characteristics when switching frequency or  $V_{OUT}$  is modified.

[4] Refer to Output Ripple plots.

[5] Refer to Load Current vs. Ambient Temperature curves.

[6] Refer to Switching Frequency vs. Load current curves.

[7] Minimum 5V between  $V_{IN}$ - $V_{OUT}$  must be maintained or a minimum load of 1mA required.

PI3305-x0-LGIZ (15.0V<sub>OUT</sub>) Electrical Characteristics (Cont.)

Unless otherwise specified: -40°C < T<sub>J</sub> < 125°C, V<sub>IN</sub> = 24V, L1 = 230nH<sup>[1]</sup>

Parameter	Symbol	Conditions	Min	Typ	Max	Unit
<b>Timing</b>						
Switching Frequency	f <sub>S</sub>	[6]		1.5		MHz
Fault Restart Delay	t <sub>FR_DLY</sub>			30		ms
<b>Sync In (SYNCI)</b>						
Synchronization Frequency Range	Δf <sub>SYNCI</sub>	Relative to set switching frequency <sup>[3]</sup>	50		110	%
SYNCI Threshold	V <sub>SYNCI</sub>			2.5		V
SYNCI Input Impedance	Z <sub>SYNCI</sub>			100		kΩ
<b>Sync Out (SYNCO)</b>						
SYNCO High	V <sub>SYNCO_HI</sub>	Source 1mA	4.5			V
SYNCO Low	V <sub>SYNCO_LO</sub>	Sink 1mA			0.5	V
SYNCO Rise Time	t <sub>SYNCO_RT</sub>	20pF load		10		ns
SYNCO Fall Time	t <sub>SYNCO_FT</sub>	20pF load		10		ns
<b>Soft Start And Tracking</b>						
TRK Active Input Range	V <sub>TRK</sub>		0		1.04	V
TRK Max Output Voltage				1.2		V
TRK Disable Threshold	V <sub>TRK_OV</sub>		20	40	60	mV
Charge Current (Soft – Start)	I <sub>TRK</sub>		70	50	30	μA
Discharge Current (Fault)	I <sub>TRK_DIS</sub>	V <sub>TRK</sub> = 0.5V		6.8		mA
Soft-Start Time	t <sub>SS</sub>	C <sub>TRK</sub> = 0μF		2.2		ms
<b>Enable</b>						
High Threshold	V <sub>EN_HI</sub>		0.9	1	1.1	V
Low Threshold	V <sub>EN_LO</sub>		0.7	0.8	0.9	V
Threshold Hysteresis	V <sub>EN_HYS</sub>		100	200	300	mV
Enable Pull-Up Voltage (Floating)	V <sub>EN_PU</sub>	With positive logic EN polarity		2		V
Enable Pull-Down Voltage (Floating)	V <sub>EN_PD</sub>	With negative logic EN polarity		0		V
Source Current	I <sub>EN_SO</sub>	With positive logic EN polarity		50		μA
Sink Current	I <sub>EN_SK</sub>	With negative logic EN polarity		50		μA

<sup>[1]</sup> All parameters reflect regulator and inductor system performance. Measurements were made using a standard PI33xx-x0 evaluation board with 3x4" dimensions and 4 layer, 2oz copper. Refer to inductor pairing table within Application Description section for specific inductor manufacturer and value.

<sup>[2]</sup> Regulator is assured to meet performance specifications by design, test correlation, characterization, and/or statistical process control.

<sup>[3]</sup> Output current capability may be limited and other performance may vary from electrical characteristics when switching frequency or V<sub>OUT</sub> is modified.

<sup>[4]</sup> Refer to Output Ripple plots.

<sup>[5]</sup> Refer to Load Current vs. Ambient Temperature curves.

<sup>[6]</sup> Refer to Switching Frequency vs. Load current curves.

<sup>[7]</sup> Minimum 5V between V<sub>IN</sub>-V<sub>OUT</sub> must be maintained or a minimum load of 1mA required.

PI3305-x0-LGIZ (15.0V<sub>OUT</sub>) Electrical Characteristics (Cont.)

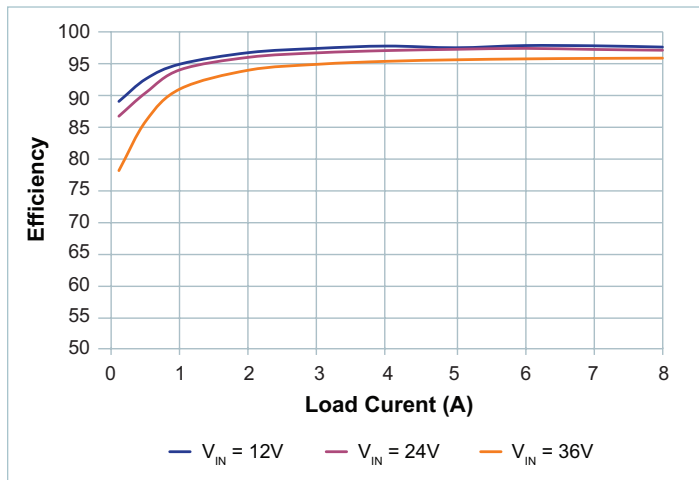

Figure 49 — Efficiency at 25°C

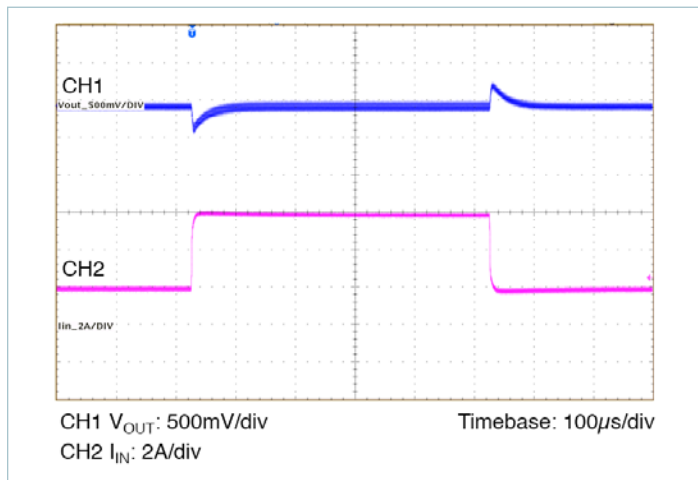

Figure 52 — Transient Response 2A to 6A, at 5A/μs

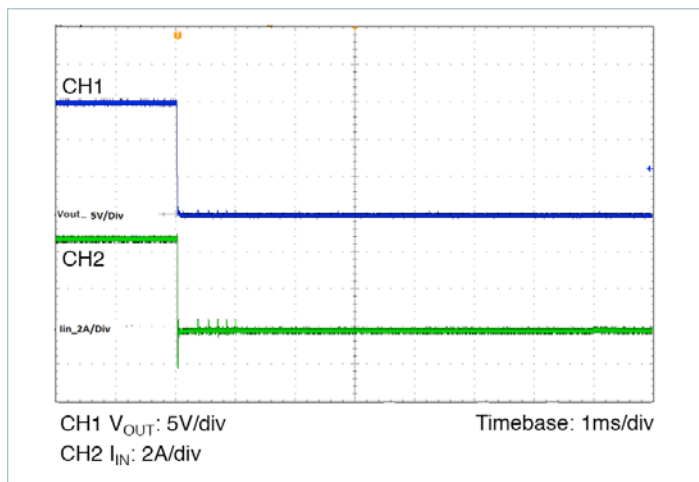

Figure 50 — Short Circuit Test

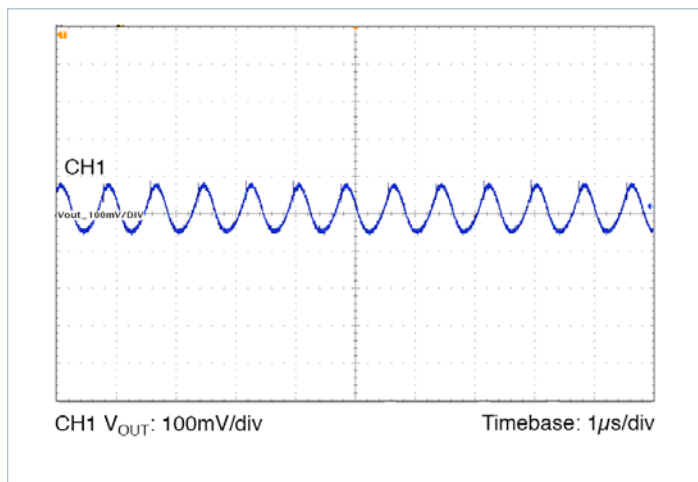

Figure 53 — Output Ripple 24V<sub>IN</sub>, 15.0V<sub>OUT</sub> at 8A

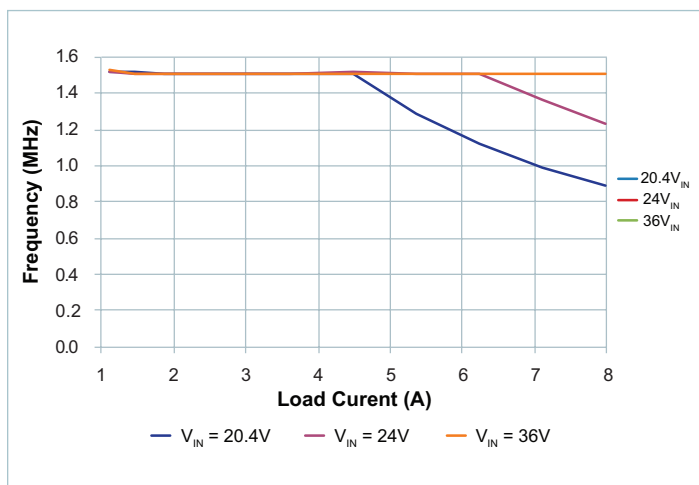

Figure 51 — Switching Frequency vs. Load Current

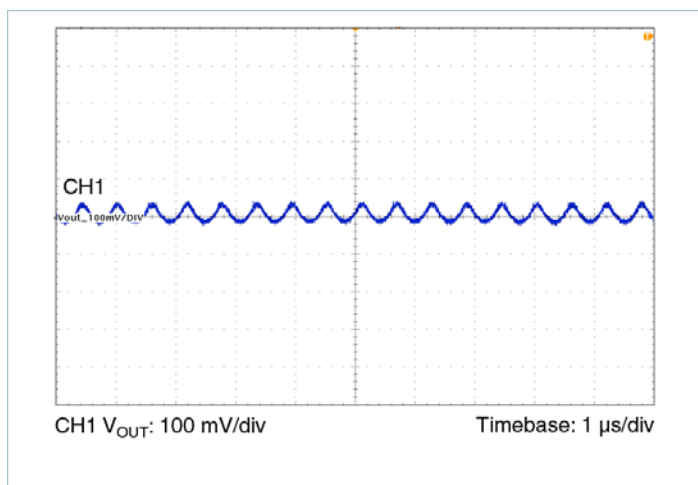

Figure 54 — Output Ripple 24V<sub>IN</sub>, 15.0V<sub>OUT</sub> at 4A

PI3305-x0-LGIZ (15.0V<sub>OUT</sub>) Electrical Characteristics (Cont.)

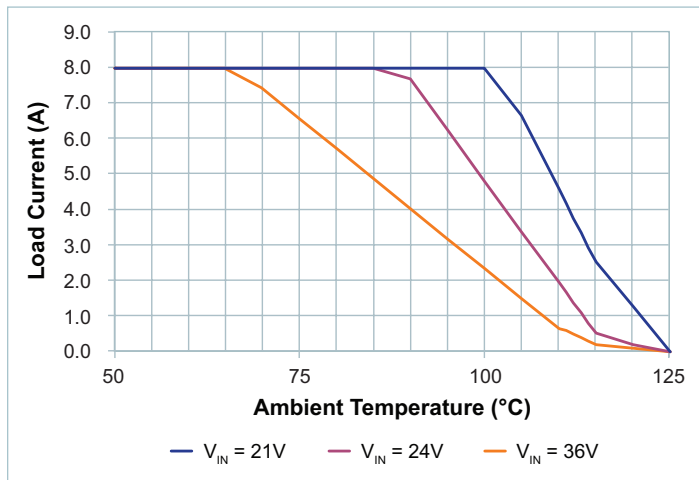

Figure 55 — Load Current vs. Ambient Temperature, 0LFM

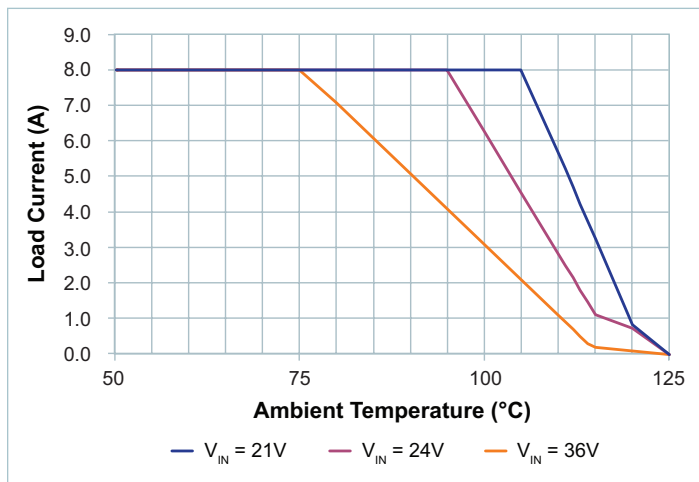

Figure 56 — Load Current vs. Ambient Temperature, 200LFM

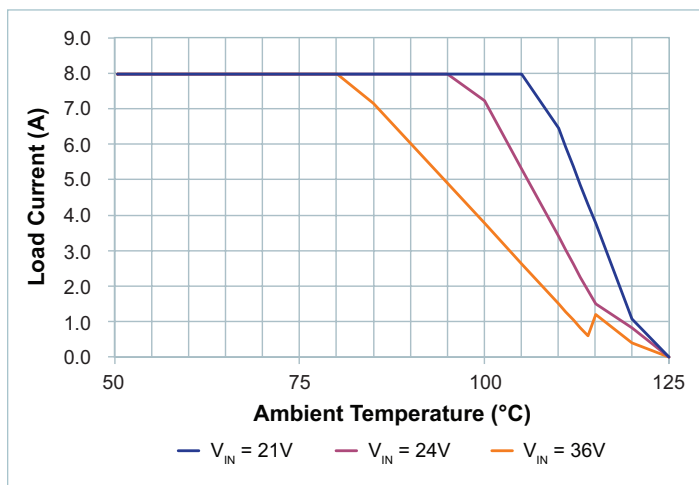

Figure 57 — Load Current vs. Ambient Temperature, 400LFM

## Functional Description

The PI33xx-x0 is a family of highly integrated ZVS-Buck regulators. The PI33xx-x0 has a set output voltage that is trimmable within a prescribed range shown in Table 1. Performance and maximum output current are characterized with a specific external power inductor (see Table 4).

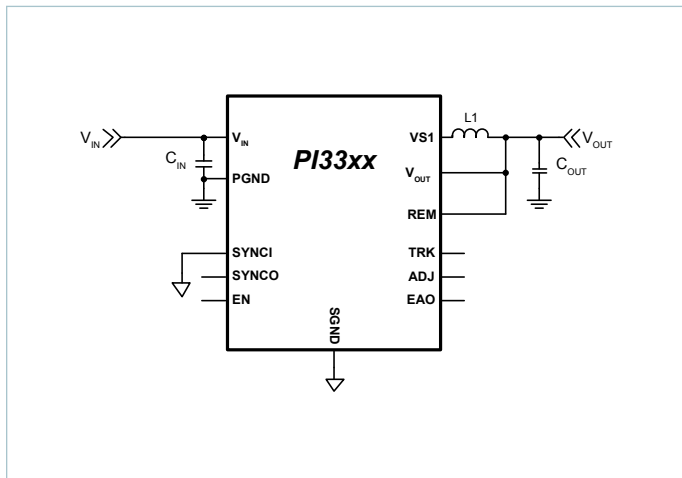

Figure 58 — ZVS-Buck with required components

For basic operation, Figure 58 shows the connections and components required. No additional design or settings are required.

### ENABLE (EN)

EN is the enable pin of the converter. The EN Pin is referenced to SGND and permits the user to turn the regulator on or off. The EN default polarity is a positive logic assertion. If the EN pin is left floating or asserted high, the converter output is enabled. Pulling EN pin below  $0.8V_{DC}$  with respect to SGND will disable the regulator output.

The EN input polarity can be programmed (PI33xx-20 device versions only) via the I<sup>2</sup>C™ data bus. When the EN pin polarity is programmed for negative logic assertion; and if the EN pin is left floating, the regulator output is enabled. Pulling the EN pin above  $1.0V_{DC}$  with respect to SGND, will disable the regulator output.

### Remote Sensing

An internal  $100\Omega$  resistor is connected between REM pin and  $V_{OUT}$  pin to provide regulation when the REM connection is broken. Referring to Figure 58, it is important to note that L1 and  $C_{OUT}$  are the output filter and the local sense point for the power supply output. As such, the REM pin should be connected at  $C_{OUT}$  as the default local sense connection unless remote sensing to compensate additional distribution losses in the system. The REM pin should not be left floating.

## Switching Frequency Synchronization

The SYNCI input allows the user to synchronize the controller switching frequency by an external clock referenced to SGND. The external clock can synchronize the unit between 50% and 110% of the preset switching frequency ( $f_s$ ). For PI33xx-20 device versions only, the phase delay can be programmed via I<sup>2</sup>C bus with respect to the clock applied at SYNCI pin. Phase delay allows PI33xx-20 regulators to be paralleled and operate in an interleaving mode.

The PI33xx-x0 default for SYNCI is to sync with respect to the falling edge of the applied clock providing  $180^\circ$  phase shift from SYNCO. This allows for the paralleling of two PI33xx-x0 devices without the need for further user programming or external sync clock circuitry. The user can change the SYNCI polarity to sync with the external clock rising edge via the I<sup>2</sup>C data bus (PI33xx-20 device versions only).

When using the internal oscillator, the SYNCO pin provides a 5V clock that can be used to sync other regulators. Therefore, one PI33xx-x0 can act as the lead regulator and have additional PI33xx-x0s running in parallel and interleaved.

### Soft-Start

The PI33xx-x0 includes an internal soft-start capacitor to ramp the output voltage in 2ms from 0V to full output voltage. Connecting an external capacitor from the TRK pin to SGND will increase the start-up ramp period. See, "Soft Start Adjustment and Track," in the Applications Description section for more details.

### Output Voltage Trim

The PI33xx-x0 output voltage can be trimmed up from the preset output by connecting a resistor from ADJ pin to SGND and can be trimmed down by connecting a resistor from ADJ pin to  $V_{OUT}$ . The Table 1 defines the voltage ranges for the PI33xx-x0 family.

Device	Output Voltage	
	Set	Range
PI3311-x0-LGIZ	1.0V	1.0 to 1.4V
PI3318-x0-LGIZ	1.8V	1.4 to 2.0V
PI3312-x0-LGIZ	2.5V	2.0 to 3.1V
PI3301-x0-LGIZ	3.3V	2.3 to 4.1V
PI3302-x0-LGIZ	5.0V	3.3 to 6.5V
PI3303-x0-LGIZ	12V	6.5 to 13.0V
PI3305-x0-LGIZ	15V	10.0 to 16.0V

Table 1 — PI33xx-x0 family output voltage range



## Output Current Limit Protection

PI33xx-x0 has two methods implemented to protect from output short or over current condition.

**Slow Current Limit protection:** prevents the output load from sourcing current higher than the regulator's maximum rated current. If the output current exceeds the Current Limit ( $I_{OUT\_CL}$ ) for  $1024\mu s$ , a slow current limit fault is initiated and the regulator is shutdown which eliminates output current flow. After Fault Restart Delay ( $t_{FR\_DLY}$ ), a soft-start cycle is initiated. This restart cycle will be repeated indefinitely until the excessive load is removed.

**Fast Current Limit protection:** PI33xx-x0 monitors the regulator inductor current pulse-by-pulse to prevent the output from supplying very high current due to sudden low impedance short (50A Typical). If the regulator senses a high inductor current pulse, it will initiate a fault and stop switching until Fault Restart Delay ends and then initiate a soft-start cycle.

Both the Fast and Slow current limit faults are stored in a Fault Register and can be read and cleared (PI33xx-20 device versions only) via I<sup>2</sup>C data bus.

## Input Undervoltage Lockout

If  $V_{IN}$  falls below the input Undervoltage Lockout (UVLO) threshold, but remains high enough to power the internal bias supply, the PI33xx-x0 will complete the current cycle, stop switching, enter a low power state and initiate a fault. The system will restart once the input voltage is reestablished and after the Fault Restart Delay. A UVLO fault is stored in a Fault Register and can be read and cleared (PI33xx-20 device versions only) via I<sup>2</sup>C data bus.

## Input Overvoltage Lockout

If  $V_{IN}$  exceeds the input Overvoltage Lockout (OVLO) threshold ( $V_{OVLO}$ ), while the controller is running, the PI33xx-x0 will complete the current cycle, stop switching, enter a low power state and set an OVLO fault. The system will resume operation when the input voltage falls below 98% of the OVLO threshold and after the Fault Restart Delay. The OVLO fault is stored in a Fault Register and can be read and cleared (PI33xx-20 device versions only) via I<sup>2</sup>C™ data bus.

## Output Overvoltage Protection

The PI33xx-x0 family is equipped with output Overvoltage Protection (OVP) to prevent damage to input voltage sensitive devices. If the output voltage exceeds 20% of its set regulated value, the regulator will complete the current cycle, stop switching and issue an OVP fault. The system will resume operation once the output voltage falls below the OVP threshold and after Fault Restart Delay. The OVP fault is stored in a Fault Register and can be read and cleared (PI33xx-20 device versions only) via I<sup>2</sup>C data bus.

## Overtemperature Protection

The internal package temperature is monitored to prevent internal components from reaching their thermal maximum. If the Over Temperature Protection Threshold (OTP) is exceeded ( $T_{OTP}$ ), the regulator will complete the current switching cycle, enter a low power mode, set a fault flag, and will soft-start when the internal temperature falls below Overtemperature Restart Hysteresis ( $T_{OTP\_HYS}$ ). The OTP fault is stored in a Fault Register and can be read and cleared (PI33xx-20 device versions only) via I<sup>2</sup>C data bus.

## Pulse Skip Mode (PSM)

PI33xx-x0 features a PSM to achieve high efficiency at light loads. The regulators are setup to skip pulses if EAO falls below a PSM threshold. Depending on conditions and component values, this may result in single pulses or several consecutive pulses followed by skipped pulses. Skipping cycles significantly reduces gate drive power and improves light load efficiency. The regulator will leave PSM once the EAO rises above the Skip Mode threshold.

## Variable Frequency Operation

Each PI33xx-x0 is preprogrammed to a base operating frequency, with respect to the power stage inductor (see Table 4), to operate at peak efficiency across line and load variations. At low line and high load applications, the base frequency will decrease to accommodate these extreme operating ranges. By stretching the frequency, the ZVS operation is preserved throughout the total input line voltage range therefore maintaining optimum efficiency.

## Parallel Operation

Paralleling modules can be used to increase the output current capability of a single power rail and reduce output voltage ripple.

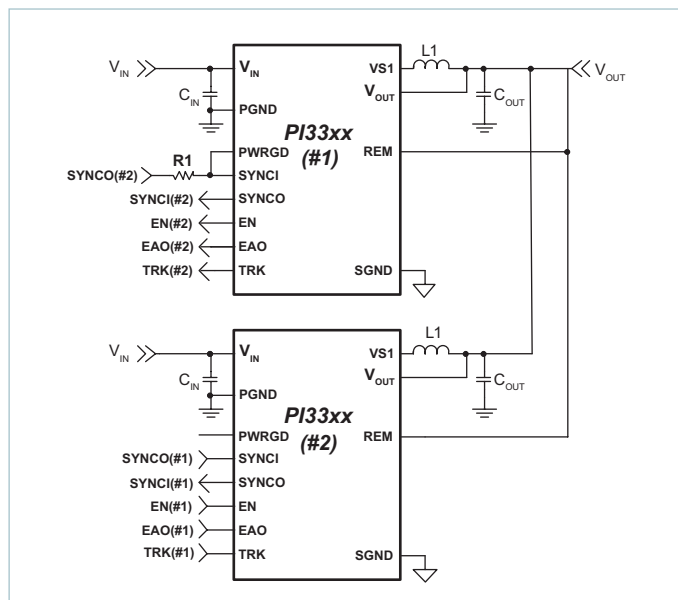

Figure 59 — PI33xx-x0 parallel operation

The PI33xx-x0 default for SYNCI is to sync with respect to the falling edge of the applied clock providing 180° phase shift from SYNCO. This allows for the paralleling of two PI33xx-x0 devices without the need for further user programming or external sync clock circuitry. The user can change the SYNCI polarity to sync with the external clock rising edge via the I<sup>2</sup>C™ data bus (PI33xx-20 device versions only).

By connecting the EAO pins and SGND pins of each module together the units will share the current equally. When the TRK pins of each unit are connected together, the units will track each other during soft-start and all unit EN pins have to be released to allow the units to start (See Figure 59). Also, any fault event in any regulator will disable the other regulators. The two regulators will be out of phase with each other reducing output ripple (refer to Switching Frequency Synchronization).

To provide synchronization between regulators over the entire operational frequency range, the Power Good (PWRGD) pin must be connected to the lead regulator's (#1) SYNCI pin and a 2.5kΩ Resistor, R1, must be placed between SYNCO (#2) return and the lead regulator's SYNCI (#1) pin, as shown in Figure 59. In this configuration, at system soft-start, the PWRGD pin pulls SYNCI low forcing the lead regulator to initialize the open-loop startup synchronization. Once the regulators reach regulation, SYNCI is released and the system is now synchronized in a closed-loop configuration which allows the system to adjust, on the fly, when any of the individual regulators begin to enter variable frequency mode in the loop.

Multi-phasing three regulators is possible (PI33xx-20 only) with no change to the basic single-phase design. For more information about how to program phase delays within the regulator, please refer to Picor application note PI33xx-2x Multi-Phase Design Guide.

### I<sup>2</sup>C™ Interface Operation

PI33xx-20 devices provide an I<sup>2</sup>C digital interface that enables the user to program the EN pin polarity (from high to low assertion) and switching frequency synchronization phase/delay. These are one time programmable options to the device.

Also, the PI33xx-20 devices allow for dynamic V<sub>OUT</sub> margining via I<sup>2</sup>C that is useful during development (settings stored in volatile memory only and not retained by the device). The PI33xx-20 also have the option for fault telemetry including:

- Fast/Slow current limit
- Output voltage high
- Input overvoltage
- Input undervoltage
- Over temperature protection

For more information about how to utilize the I<sup>2</sup>C interface please refer to Picor application note PI33xx-2x I<sup>2</sup>C Digital Interface Guide.

## Application Description

### Output Voltage Trim

The PI33xx-x0 family of Buck Regulators provides seven common output voltages: 1.0V, 1.8V, 2.5V, 3.3V, 5.0V, 12V and 15V. A post-package trim step is implemented to offset any resistor divider network errors ensuring maximum output accuracy. With a single resistor connected from the ADJ pin to SGND or REM, each device's output can be varied above or below the nominal set voltage (with the exception of the PI3311-X0 which can only be above the set voltage of 1V).

Device	Output Voltage	
	Set	Range
PI3311-x0	1.0V	1.0 to 1.4V
PI3318-x0	1.8V	1.4 to 2.0V
PI3312-x0	2.5V	2.0 to 3.1V
PI3301-x0	3.3V	2.3 to 4.1V
PI3302-x0	5.0V	3.3 to 6.5V
PI3303-x0	12V	6.5 to 13.0V
PI3305-x0	15V	10.0 to 16.0V

**Table 2** — PI33xx-x0 family output voltage range

The remote pin (REM) should always be connected to the V<sub>OUT</sub> pin, if not used, to prevent an output voltage offset. Figure 60 shows the internal feedback voltage divider network.

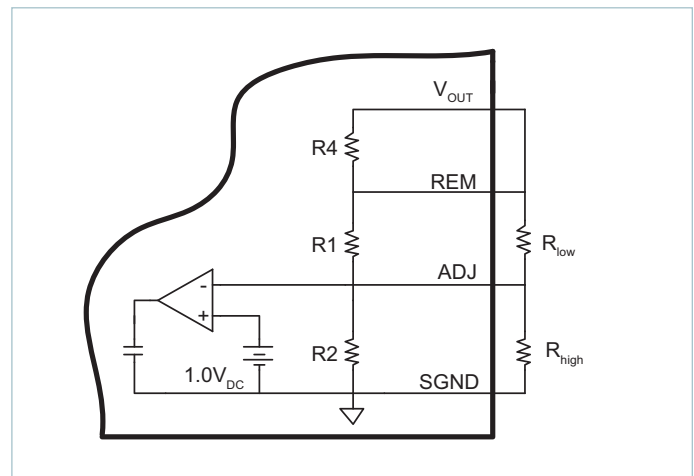

**Figure 60** — Internal resistor divider network

R1, R2, and R4 are all internal 1.0% resistors and R<sub>low</sub> and R<sub>high</sub> are external resistors for which the designer can add to modify V<sub>OUT</sub> to a desired output. The internal resistor value for each regulator is listed below in Table 3.

Device	R1	R2	R4
PI3311-x0-LGIZ	1kΩ	Open	100Ω
PI3318-x0-LGIZ	0.806kΩ	1.0kΩ	100Ω
PI3312-x0-LGIZ	1.5kΩ	1.0kΩ	100Ω
PI3301-x0-LGIZ	2.61kΩ	1.13kΩ	100Ω
PI3302-x0-LGIZ	4.53kΩ	1.13kΩ	100Ω
PI3303-x0-LGIZ	11.0kΩ	1.0kΩ	100Ω
PI3305-x0-LGIZ	14.0kΩ	1.0kΩ	100Ω

**Table 3** — PI33xx-x0 Internal divider values

By choosing an output voltage value within the ranges stated in Table 2,  $V_{OUT}$  can simply be adjusted up or down by selecting the proper  $R_{high}$  or  $R_{low}$  value, respectively. The following equations can be used to calculate  $R_{high}$  and  $R_{low}$  values:

$$R_{high} = \frac{1}{\left(\frac{V_{OUT} - 1}{R1}\right) - \left(\frac{1}{R2}\right)} \quad (1)$$

$$R_{low} = \frac{1}{\frac{1}{R2(V_{OUT} - 1)} - \left(\frac{1}{R1}\right)} \quad (2)$$

If, for example, a 4.0V output is needed, the user should choose the regulator with a trim range covering 4.0V from Table 2. For this example, the PI3301 is selected (3.3V set voltage). First step would be to use Equation (1) to calculate  $R_{high}$  since the required output voltage is higher than the regulator set voltage. The resistor-divider network values for the PI3301 are can be found in Table 3 and are  $R1 = 2.61k\Omega$  and  $R2 = 1.13k\Omega$ . Inserting these values in to Equation (1),  $R_{high}$  is calculated as follows:

$$3.78k\Omega = \frac{1}{\left(\frac{4.0 - 1}{2.61k\Omega}\right) - \left(\frac{1}{1.13k\Omega}\right)} \quad (3)$$

Resistor  $R_{high}$  should be connected as shown in Figure 60 to achieve the desired 4.0V regulator output. No external  $R_{low}$  resistor is need in this design example since the trim is above the regulator set voltage.

The PI3311-xx output voltage can only be trimmed higher than the factory 1V setting. The following Equation (4) can be used calculate  $R_{high}$  values for the PI3311-xx regulators.

$$R_{high(1V)} = \frac{1}{\left(\frac{V_{OUT} - 1}{R1}\right)} \quad (4)$$

**Soft-Start Adjust and Tracking**

The TRK pin offers a means to increase the regulator’s soft-start time or to track with additional regulators. The soft-start slope is controlled by an internal 100nF and a fixed charge current to provide a minimum startup time of 2ms (typical) for all PI33xx-x0 regulators. By adding an additional external capacitor to the TRK

pin, the soft-start time can be increased further. The following equation can be used to calculate the proper capacitor for a desired soft-start times:

$$C_{TRK} = (t_{TRK} \cdot I_{TRK}) - 100 \cdot 10^{-9} \quad (5)$$

Where  $t_{TRK}$  is the soft-start time and  $I_{TRK}$  is a 50μA internal charge current (see Electrical Characteristics for limits).

There is typically either proportional or direct tracking implemented within a design. For proportional tracking between several regulators at startup, simply connect all devices TRK pins together. This type of tracking will force all connected regulators to startup and reach regulation at the same time (see Figure 61(a)).

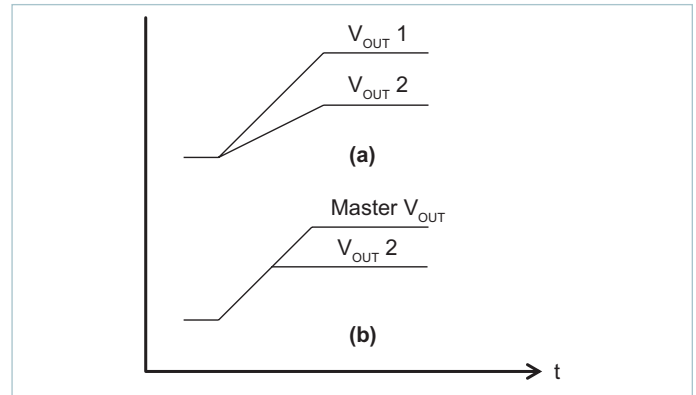

**Figure 61** — PI33xx-x0 tracking methods

For Direct Tracking, choose the regulator with the highest output voltage as the master and connect the master to the TRK pin of the other regulators through a divider (Figure 62) with the same ratio as the slave’s feedback divider (see Table 3 for values).

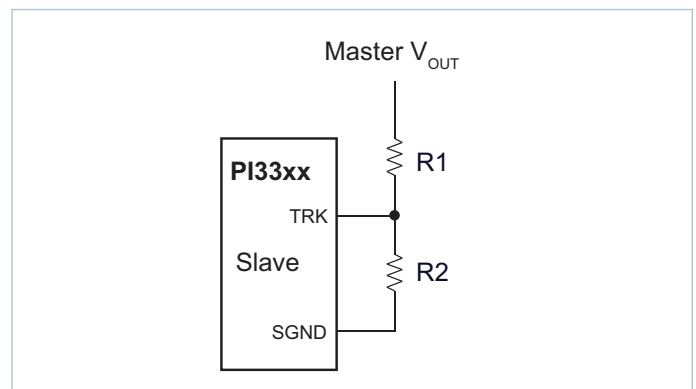

**Figure 62** — Voltage divider connections for direct tracking

All connected regulators’ soft-start slopes will track with this method. Direct tracking timing is demonstrated in Figure 61(b). All tracking regulators should have their Enable (EN) pins connected together to work properly.

## Inductor Pairing

The PI33xx-x0 utilizes an external inductor. This inductor has been optimized for maximum efficiency performance. Table 4 details the specific inductor value and part number utilized for each PI33xx-x0 device which are available from Coiltronics and Eaton. Data sheets are available at:

<http://www.cooperindustries.com>

Device	Inductor [nH]	Inductor Part Number	Manufacturer
PI3311-x0	125	FPV1006-125-R	Eaton
PI3318-x0	150	FPV1006-150-R	Eaton
PI3312-x0	200	FPT705-200-R	Coiltronics
PI3301-x0	200	FPT705-200-R	Coiltronics
PI3302-x0	200	FPT705-200-R	Coiltronics
PI3303-x0	230	FPT705-230-R	Coiltronics
PI3305-x0	230	FPT705-230-R	Coiltronics

**Table 4** — PI33xx-x0 Inductor pairing

## Thermal Derating

Thermal de-rating curves are provided that are based on component temperature changes versus load current, input voltage and air flow. It is recommended to use these curves as a guideline for proper thermal de-rating. These curves represent the entire system and are inclusive to both the PI33xx-x0 regulator and the external inductor. Maximum thermal operation is limited by either the MOSFETs or inductor depending upon line and load conditions.

Thermal measurements were made using a standard PI33xx-x0 Evaluation board which is 3 x 4 inches in area and uses 4-layer, 2oz copper. Thermal measurements were made on the three main power devices, the two internal MOSFETs and the external inductor, with air flows of 0, 200, and 400LFM.

## Filter Considerations

The PI33xx-x0 requires input bulk storage capacitance as well as low impedance ceramic X5R input capacitors to ensure proper start up and high frequency decoupling for the power stage. The PI33xx-x0 will draw nearly all of the high frequency current from the low impedance ceramic capacitors when the main high side MOSFET is conducting. During the time the high side MOSFET is off, they are replenished from the bulk capacitor. If the input impedance is high at the switching frequency of the converter, the bulk capacitor must supply all of the average current into the converter, including replenishing the ceramic capacitors. This value has been chosen to be 100 $\mu$ F so that the PI33xx-x0 can start up into a full resistive load and supply the output capacitive load with the default minimum soft start capacitor when the input source impedance is 50 $\Omega$  at 1MHz. The ESR for this capacitor should be approximately 20m $\Omega$ . The RMS ripple current in this capacitor is small, so it should not be a concern if the input recommended ceramic capacitors are used. Table 5 shows the recommended input and output capacitors to be used for the various models as well as expected transient response, RMS ripple currents per capacitor, and input and output ripple voltages.

Table 6 includes the recommended input and output ceramic capacitors.

Device	V <sub>IN</sub> (V)	I <sub>LOAD</sub> (A)	C <sub>INPUT</sub> Ceramic X5R	C <sub>INPUT</sub> Bulk Elec.	C <sub>OUTPUT</sub> Ceramic X5R	C <sub>INPUT</sub> Ripple Current (I <sub>RMS</sub> )	C <sub>OUTPUT</sub> Ripple Current (I <sub>RMS</sub> )	Input Ripple (mVpp)	Output Ripple (mVpp)	Output Ripple (mVpp)	Recovery Time ( $\mu$ s)	Load Step (A) (Slew/ $\mu$ s)
PI3311	24	10	4 x 4.7 $\mu$ F 50V	100 $\mu$ F 50V	8 X 100 $\mu$ F 2 X 1 $\mu$ F 1 X 0.1 $\mu$ F	0.5	0.8	120	20	$\pm$ 40	40	5 (5A/ $\mu$ s)
		100						15				
PI3318	24	10	4 x 4.7 $\mu$ F 50	100 $\mu$ F 50V	6 X 100 $\mu$ F 2 X 1 $\mu$ F 1 X 0.1 $\mu$ F	0.5	0.8	120	20	$\pm$ 40	40	5 (5A/ $\mu$ s)
		100						15				
PI3312	24	10	4 x 4.7 $\mu$ F	100 $\mu$ F 50V	4 X 100 $\mu$ F 2 X 1 $\mu$ F 1 X 0.1 $\mu$ F	1	1.75	150	50	$\pm$ 80	25	5 (10A/ $\mu$ s)
		100						24				
PI3301	24	10	4 x 4.7 $\mu$ F	100 $\mu$ F 50V	4 X 100 $\mu$ F 2 X 1 $\mu$ F 1 X 0.1 $\mu$ F	1.05	1.625	200	40	$\pm$ 100	20	5 (10A/ $\mu$ s)
		125						33				
PI3302	24	10	4 x 4.7 $\mu$ F	100 $\mu$ F 50V	4 X 47 $\mu$ F 2 X 1 $\mu$ F 1 X 0.1 $\mu$ F	1.2	1.5	220	50	$\pm$ 170	30	5 (5A/ $\mu$ s)
		140						30				
PI3303	24	8	4 x 4.7 $\mu$ F	100 $\mu$ F 50V	4 X 22 $\mu$ F 2 X 1 $\mu$ F 1 X 0.1 $\mu$ F	1.3	1.36	275	100	$\pm$ 300	30	4 (10A/ $\mu$ s)
		150						60				
PI3305	24	8	4 x 4.7 $\mu$ F	100 $\mu$ F 50V	4 X 22 $\mu$ F 2 X 1 $\mu$ F 1 X 0.1 $\mu$ F	1.38	1.2	280	150	$\pm$ 400	30	4 (10A/ $\mu$ s)
		160						75				

**Table 5** — Recommended input and output capacitance

Murata Part Number	Description
GRM188R71C105KA12D	1µF 16V 0603 X7R
GRM319R71H104KA01D	0.1µF 50V 1206 X7R
GRM31CR60J107ME39L	100µF 6.3V 1206 X5R
GRM31CR71H475KA12K	4.7µF 50V 1206 X7R
GRM31CR61A476ME15L	47µF 10V 1206 X5R
GRM31CR61E226KE15L	22µF 25V 1206 X5R

**Table 6** — Capacitor manufacturer part numbers

### Layout Guidelines

To optimize maximum efficiency and low noise performance from a PI33xx-x0 design, layout considerations are necessary. Reducing trace resistance and minimizing high current loop returns along with proper component placement will contribute to optimized performance.

A typical buck converter circuit is shown in Figure 63. The potential areas of high parasitic inductance and resistance are the circuit return paths, shown as LR below.

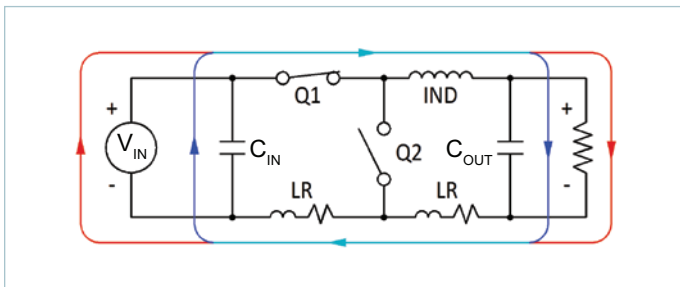

**Figure 63** — Typical Buck Converter

The path between the  $C_{OUT}$  and  $C_{IN}$  capacitors is of particular importance since the AC currents are flowing through both of them when Q1 is turned on.

Figure 64, schematically, shows the reduced trace length between input and output capacitors. The shorter path lessens the effects that copper trace parasitics can have on the PI33xx-x0 performance.

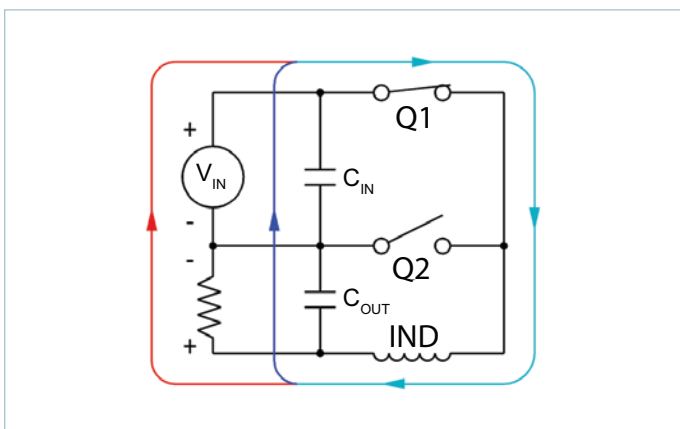

**Figure 64** — Current flow: Q1 closed

When Q1 is on and Q2 is off, the majority of  $C_{IN}$ 's current is used to satisfy the output load and to recharge the  $C_{OUT}$  capacitors. When Q1 is off and Q2 is on, the load current is supplied by the inductor and the  $C_{OUT}$  capacitor as shown in Figure 65. During this period  $C_{IN}$  is also being recharged by the  $V_{IN}$ . Minimizing  $C_{IN}$  loop inductance is important to reduce peak voltage excursions when Q1 turns off. Also, the difference in area between the  $C_{IN}$  loop and  $C_{OUT}$  loop is vital to minimize switching and GND noise.

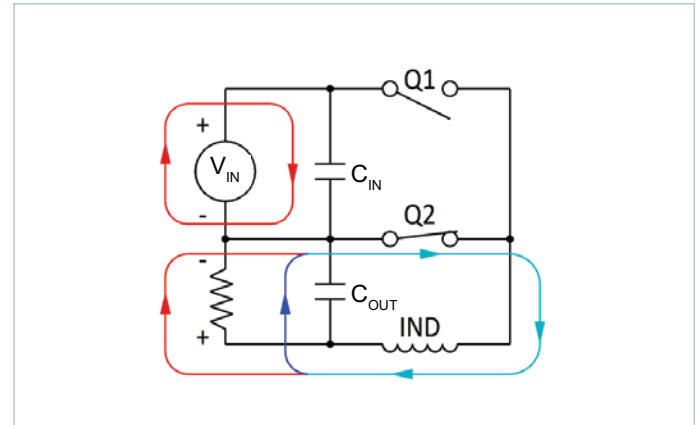

**Figure 65** — Current flow: Q2 closed

The recommended component placement, shown in Figure 66, illustrates the tight path between  $C_{IN}$  and  $C_{OUT}$  (and  $V_{IN}$  and  $V_{OUT}$ ) for the high AC return current. This optimized layout is used on the PI33xx-x0 evaluation board.

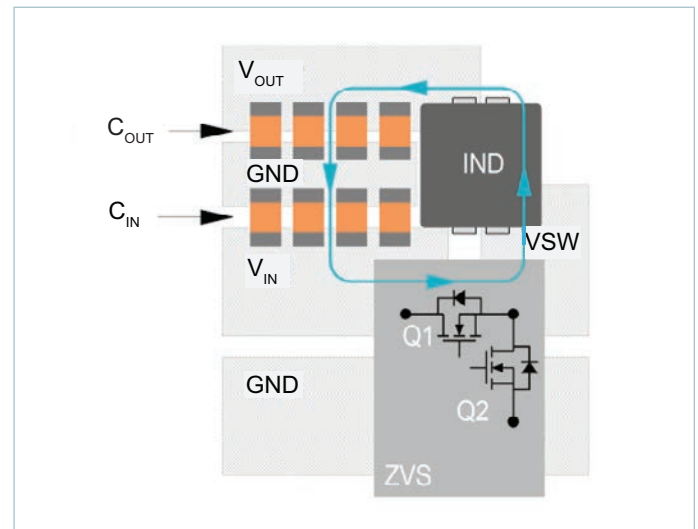

**Figure 66** — Recommended component placement and metal routing

Figure 67 details the recommended receiving footprint for PI33xx-x0 10mm x 14mm package. All pads should have a final copper size of 0.55mm x 0.55mm, whether they are solder-mask defined or copper defined, on a 1mm x 1mm grid. All stencil openings are 0.45mm when using either a 5mil or 6mil stencil.

Recommended PCB Footprint and Stencil

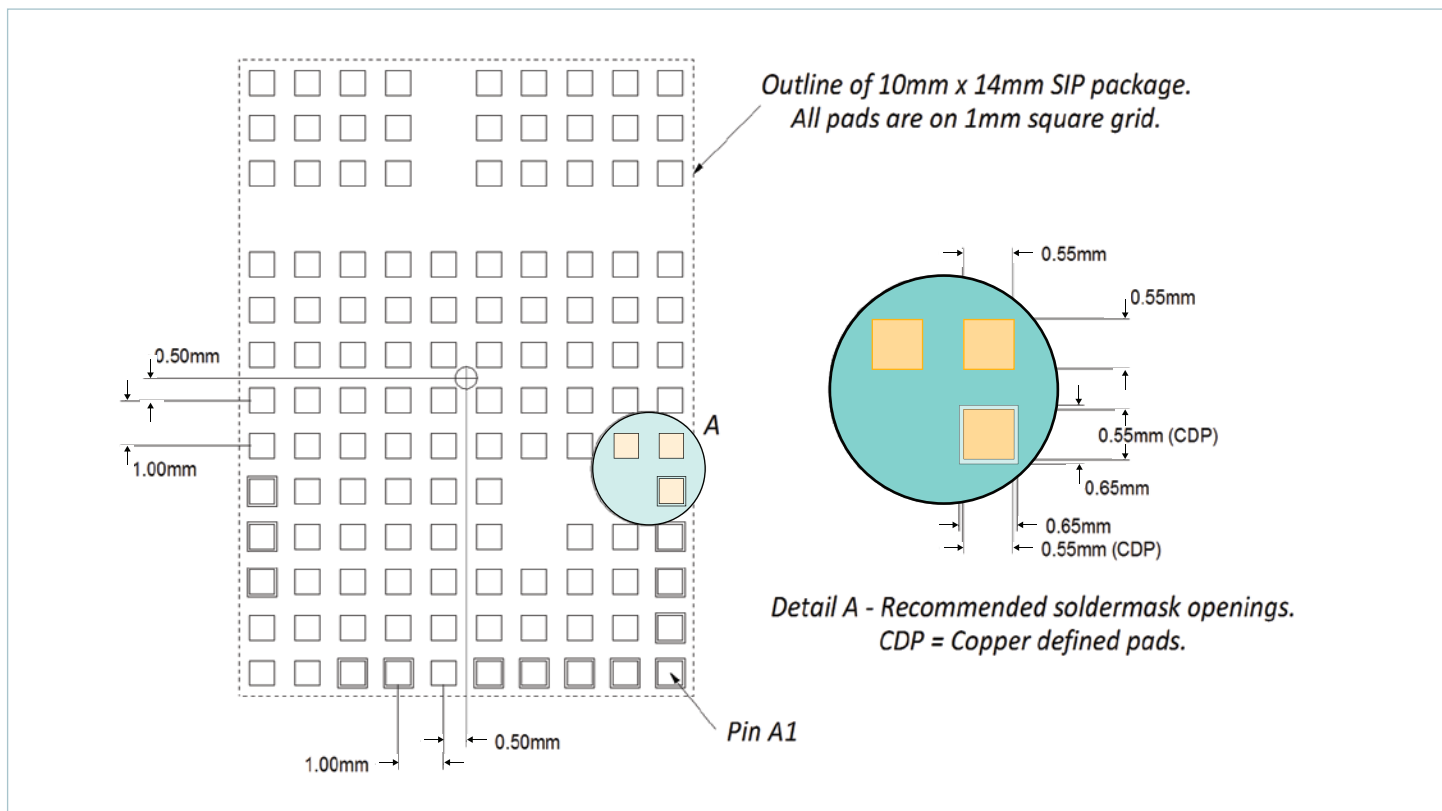
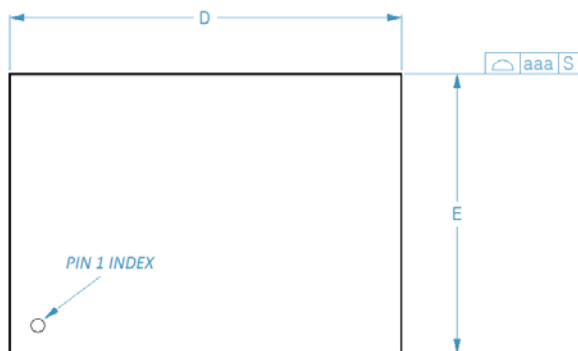

Figure 67 — Recommended Receiving PCB footprint



LGIZ Package Drawing



TOP VIEW

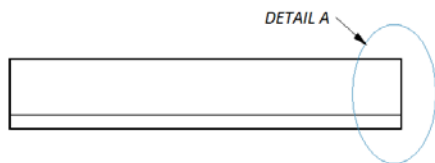

SIDE VIEW

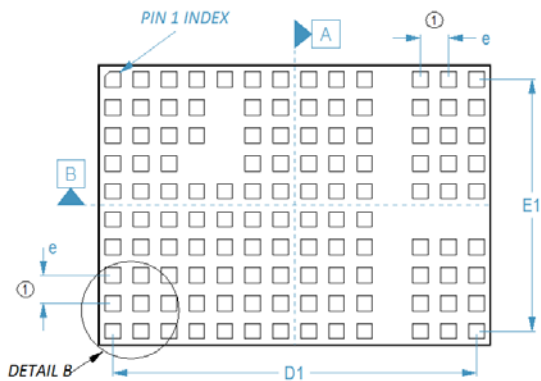

BOTTOM VIEW

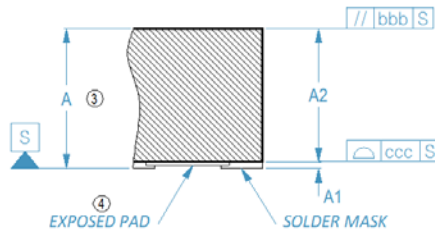

DETAIL A

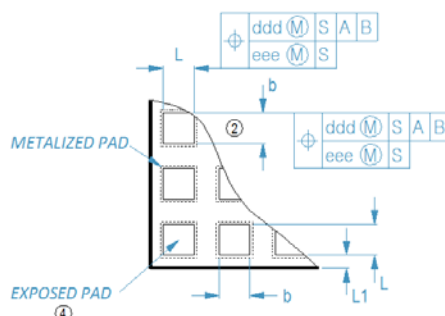

DETAIL B

DIMENSIONAL REFERENCES

REF.	MIN	NOM	MAX
A	2.50	2.56	2.62
A1	---	---	0.05
A2	---	---	2.57
b	0.50	0.55	0.60
L	0.50	0.55	0.60
D	14.00 BSC		
E	10.00 BSC		
D1	13.00 BSC		
E1	9.00 BSC		
e	1.00 BSC		
L1	0.10	0.15	0.20
aaa	0.10		
bbb	0.10		
ccc	0.08		
ddd	0.10		
eee	0.08		

Notes :

- ① 'e' REPRESENTS THE BASIC TERMINAL PITCH. SPECIFIES THE TRUE GEOMETRIC POSITION OF THE TERMINAL AXIS.
- ② DIMENSION 'b' APPLIES TO METALLIZED TERMINAL AND IS MEASURED BETWEEN 0.00mm AND 0.25mm FROM TERMINAL TIP.
- ③ DIMENSION 'A' INCLUDES PACKAGE WARPAGE.
- ④ EXPOSED METALLIZED PADS ARE CU PADS WITH SURFACE FINISH PROTECTION.
5. ALL DIMENSIONS ARE IN MILLIMETERS.

## Revision History

Revision	Date	Description	Page Number(s)
1.5	06/13	Last release in old format	n/a
1.6	08/03/15	Reformatted in new template	n/a
1.7	08/21/15	Formatting edits	6, 21, 22, 25, 26, 29, 30 & 36
1.8	09/18/15	Formatting edits	all
1.9	01/06/16	Clarifications made in Enable Pin Conditions BGA package added	7, 18, 22, 26 & 30 1, 3, 20-23, 34 & 40
2.0	02/22/16	Corrected Input Current spec unit of measure from mA to A	12, 16, 20, 24 & 28
2.1	05/27/16	Revised Output Voltage Total Regulation	12
2.2	08/22/16	Corrected typo in temp range for Electrical Characteristics tables	7, 9, 10, 12, 13, 16, 17, 20, 21, 24, 25, 28 & 29
2.3	11/21/16	Clarified VS1 rating in Absolute Maximum Ratings Table Updated pin description table and package pin-out labels to show VDR capability	4 5
2.4	02/10/17	Block diagram typo corrected, VS1 Spec expanded PWRGD Pin Description updated Specification conditions clarified	4 5 6, 9
2.5	06/01/17	Move BGA package to separate data sheet Corrections	1, 3, 20-23, 40 1, 6-7, 9-31, 35

Note: page removed in Revision 2.5.



**Vicor's comprehensive line of power solutions includes high density AC-DC and DC-DC modules and accessory components, fully configurable AC-DC and DC-DC power supplies, and complete custom power systems.**

Information furnished by Vicor is believed to be accurate and reliable. However, no responsibility is assumed by Vicor for its use. Vicor makes no representations or warranties with respect to the accuracy or completeness of the contents of this publication. Vicor reserves the right to make changes to any products, specifications, and product descriptions at any time without notice. Information published by Vicor has been checked and is believed to be accurate at the time it was printed; however, Vicor assumes no responsibility for inaccuracies. Testing and other quality controls are used to the extent Vicor deems necessary to support Vicor's product warranty. Except where mandated by government requirements, testing of all parameters of each product is not necessarily performed.

**Specifications are subject to change without notice.**

Visit <http://www.vicorpower.com/dc-dc-converters-board-mount/cool-power-pi33xx-and-pi34xx> for the latest product information.

**Vicor's Standard Terms and Conditions and Product Warranty**

All sales are subject to Vicor's Standard Terms and Conditions of Sale, and Product Warranty which are available on Vicor's webpage (<http://www.vicorpower.com/termsconditionswarranty>) or upon request.

**Life Support Policy**

VICOR'S PRODUCTS ARE NOT AUTHORIZED FOR USE AS CRITICAL COMPONENTS IN LIFE SUPPORT DEVICES OR SYSTEMS WITHOUT THE EXPRESS PRIOR WRITTEN APPROVAL OF THE CHIEF EXECUTIVE OFFICER AND GENERAL COUNSEL OF VICOR CORPORATION. As used herein, life support devices or systems are devices which (a) are intended for surgical implant into the body, or (b) support or sustain life and whose failure to perform when properly used in accordance with instructions for use provided in the labeling can be reasonably expected to result in a significant injury to the user. A critical component is any component in a life support device or system whose failure to perform can be reasonably expected to cause the failure of the life support device or system or to affect its safety or effectiveness. Per Vicor Terms and Conditions of Sale, the user of Vicor products and components in life support applications assumes all risks of such use and indemnifies Vicor against all liability and damages.

**Intellectual Property Notice**

Vicor and its subsidiaries own Intellectual Property (including issued U.S. and Foreign Patents and pending patent applications) relating to the products described in this data sheet. No license, whether express, implied, or arising by estoppel or otherwise, to any intellectual property rights is granted by this document. Interested parties should contact Vicor's Intellectual Property Department.

The products described on this data sheet are protected by U.S. Patents. Please see [www.vicorpower.com/patents](http://www.vicorpower.com/patents) for the latest patent information.

Contact Us: <http://www.vicorpower.com/contact-us>

**Vicor Corporation**  
25 Frontage Road  
Andover, MA, USA 01810  
Tel: 800-735-6200  
Fax: 978-475-6715  
[www.vicorpower.com](http://www.vicorpower.com)

**email**

Customer Service: [custserv@vicorpower.com](mailto:custserv@vicorpower.com)  
Technical Support: [apps@vicorpower.com](mailto:apps@vicorpower.com)

©2018 Vicor Corporation. All rights reserved. The Vicor name is a registered trademark of Vicor Corporation.  
All other trademarks, product names, logos and brands are property of their respective owners.

# Mouser Electronics

Authorized Distributor

Click to View Pricing, Inventory, Delivery & Lifecycle Information:

[Vicor:](#)

[PI3303-20-LGIZ](#) [PI3312-20-LGIZ](#) [PI3302-00-LGIZ](#) [PI3305-20-LGIZ](#) [PI3318-00-LGIZ](#) [PI3311-00-LGIZ](#) [PI3311-20-LGIZ](#) [PI3318-20-LGIZ](#) [PI3305-00-LGIZ](#) [PI3312-00-LGIZ](#) [PI3302-20-LGIZ](#) [PI3301-00-LGIZ](#) [PI3303-00-LGIZ](#) [PI3301-20-LGIZ](#)