

THIS DRAWING IS UNPUBLISHED.

RELEASED FOR PUBLICATION

2011

© COPYRIGHT 2011

ALL RIGHTS RESERVED.

LOC AI DIST -

REVISIONS

P	LTR	DESCRIPTION	DATE	DWN	APVD
	A	REVISED PER ECO-12-002880	15FEB12	KH	MS

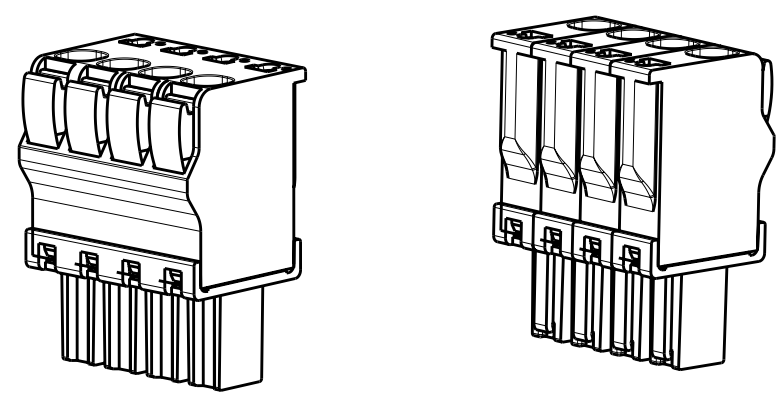
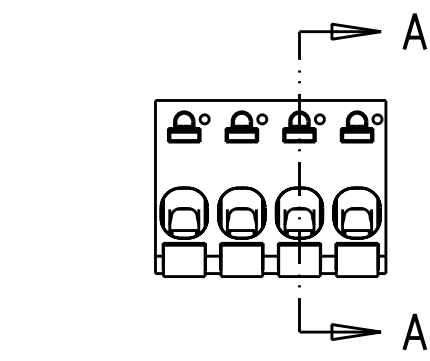
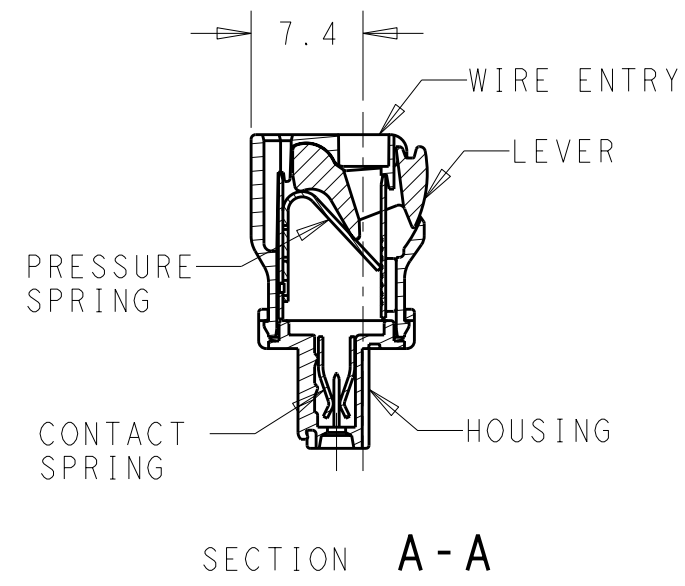
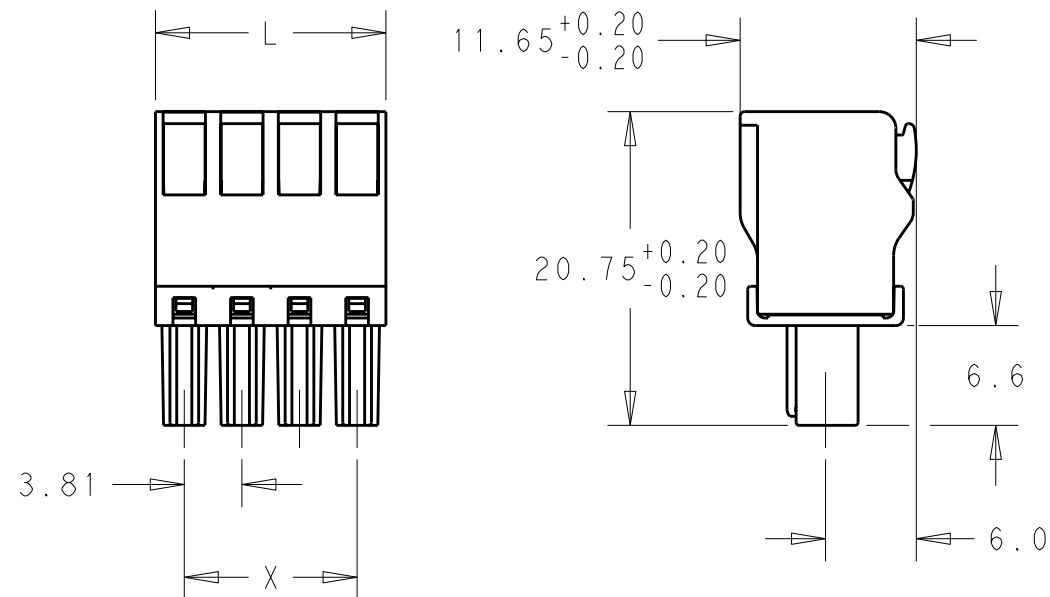

DIM X	DIM L	POLE	PART NUMBER
91.44	95.25	25	2-1986722-5
87.63	91.44	24	2-1986722-4
83.82	87.63	23	2-1986722-3
80.01	83.82	22	2-1986722-2
76.20	80.01	21	2-1986722-1
72.39	76.20	20	2-1986722-0
68.58	72.39	19	1-1986722-9
64.77	68.58	18	1-1986722-8
60.96	64.77	17	1-1986722-7
57.15	60.96	16	1-1986722-6
53.34	57.15	15	1-1986722-5
49.53	53.34	14	1-1986722-4
45.72	49.53	13	1-1986722-3
41.91	45.72	12	1-1986722-2
38.10	41.91	11	1-1986722-1
34.29	38.10	10	1-1986722-0
30.48	34.29	9	1986722-9
26.67	30.48	8	1986722-8
22.86	26.67	7	1986722-7
19.05	22.86	6	1986722-6
15.24	19.05	5	1986722-5
11.43	15.24	4	1986722-4
7.62	11.43	3	1986722-3
3.81	7.62	2	1986722-2

MATERIAL
 HOUSING-POLYAMIDE, COLOR-GREEN
 LEVER-POLYAMIDE, COLOR ORANGE
 CONTACT SPRING-COPPER ALLOY-LEAD FREE TIN PLATED
 CLAMPING SPRING-STEEL

MECHANICAL
 INSERTION FORCE PER POLE- 3 NEWTON MAX
 WITHDRAWAL FORCE PER POLE- 1.5 NEWTON MIN
 STRIPPING LENGTH- 10.5 TO 11.5 MM
 OPERATING TEMPERATURE--40°C TO +110°C

ELECTRICAL
 WIRE SIZE= 30 TO 14 AWG SOLID OR STRANDED
 VOLTAGE RATING- 300 VOLTS
 CURRENT RATING- 11 AMP STRANDED; 9AMP SOLID
 CONTACT RESISTANCE-15 MILLOHM MAX
 INSULATION RESISTANCE-10⁹ OHMS MIN (500V DC)

THIS DRAWING IS A CONTROLLED DOCUMENT.		DWN 12JAN2012 KIRAN HOLAL	TE Connectivity													
DIMENSIONS: mm		CHK 12JAN2012 MIKE SARVER														
TOLERANCES UNLESS OTHERWISE SPECIFIED:		APVD 12JAN2012 MIKE SARVER	NAME STRAIGHT SPRING TYPE PLUG CONNECTOR, SIDE STACKABLE LEFT, 02 - 25 POLES, PITCH 3.81mm													
<table border="1"> <tr><td>0 PLC</td><td>±-</td></tr> <tr><td>1 PLC</td><td>±0.40</td></tr> <tr><td>2 PLC</td><td>±0.20</td></tr> <tr><td>3 PLC</td><td>±-</td></tr> <tr><td>4 PLC</td><td>±-</td></tr> <tr><td>ANGLES</td><td>±1°</td></tr> </table>		0 PLC	±-	1 PLC	±0.40	2 PLC	±0.20	3 PLC	±-	4 PLC	±-	ANGLES	±1°	PRODUCT SPEC	SIZE CAGE CODE DRAWING NO RESTRICTED TO	
0 PLC	±-															
1 PLC	±0.40															
2 PLC	±0.20															
3 PLC	±-															
4 PLC	±-															
ANGLES	±1°															
MATERIAL - FINISH -		APPLICATION SPEC	A300779 C-1986722													
		WEIGHT -	SCALE 2:1 SHEET 1 OF 1 REV A													
		CUSTOMER DRAWING														

Mouser Electronics

Authorized Distributor

Click to View Pricing, Inventory, Delivery & Lifecycle Information:

[TE Connectivity:](#)

[2-1986722-1](#)