

ABS05-HF Thru. ABS10-HF

Reverse Voltage: 50 to 1000 Volts

Forward Current: 1.0 A

RoHS Device

Halogen Free

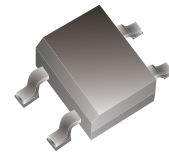

Features

- Rating to 1000V PRV.
- Ideal for printed circuit board.
- Lead tin plated copper.
- UL recognized file # E349301

Mechanical data

- Polarity: Symbol molded on body.
- Mounting position: Any.
- Weight: 0.08 grams.

Circuit Diagram

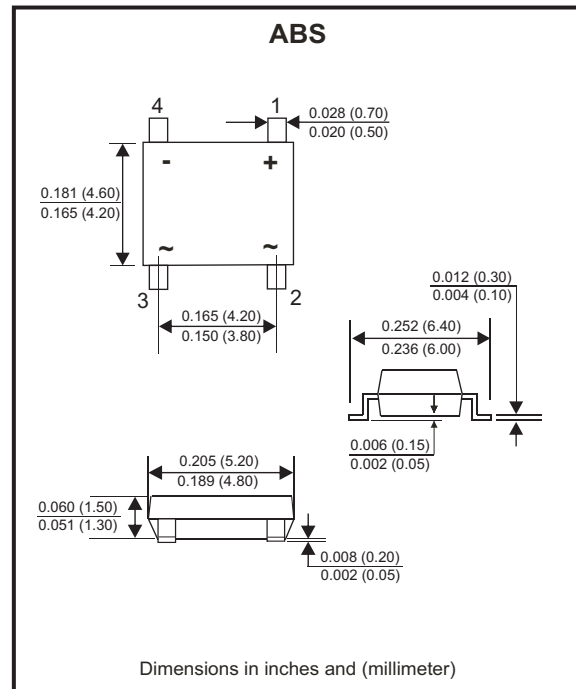
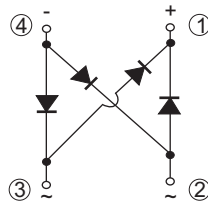

Maximum Rating And Electrical Characteristics

Rating at $T_A=25^{\circ}\text{C}$, unless otherwise noted.
 Single phase, half wave, 60Hz, resistive or inductive load.
 For capacitive load, derate current by 20%.

Parameter	Symbol	ABS05-HF	ABS1-HF	ABS2-HF	ABS4-HF	ABS6-HF	ABS8-HF	ABS10-HF	Unit
Maximum Recurrent Peak Reverse Voltage	V_{RRM}	50	100	200	400	600	800	1000	V
Maximum RMS Voltage	V_{RMS}	35	70	140	280	420	560	700	V
Maximum DC Blocking Voltage	V_{DC}	50	100	200	400	600	800	1000	V
Maximum Average Forward Rectified Current (Note 1) @ $T_A=40^{\circ}\text{C}$	$I_{(AV)}$	1.0							A
Peak Forward Surge Current, 8.3ms Single Half Sine-Wave, Super Imposed on Rated Load (JEDEC Method)	I_{FSM}	30							A
Maximum Forward Voltage at 1.0A DC	V_F	1.1							V
Maximum DC Reverse Current @ $T_J=25^{\circ}\text{C}$ at Rated DC Blocking Voltage @ $T_J=125^{\circ}\text{C}$	I_R	5.0 500							μA
Typical Thermal Resistance (Note 2)	$R_{\theta JA}$	80							$^{\circ}\text{C/W}$
Typical Thermal Resistance	$R_{\theta JC}$	12							$^{\circ}\text{C/W}$
Operating Temperature Range	T_J	-55 to +150							$^{\circ}\text{C}$
Storage Temperature Range	T_{STG}	-55 to +150							$^{\circ}\text{C}$

Notes: 1. Mounted on P.C.Board.
 2. Thermal resistance junction to ambient.

Company reserves the right to improve product design , functions and reliability without notice.

REV: D

RATING AND CHARACTERISTIC CURVES (ABS05-HF thru ABS10-HF)

Fig.1 - Forward Current Derating Curve

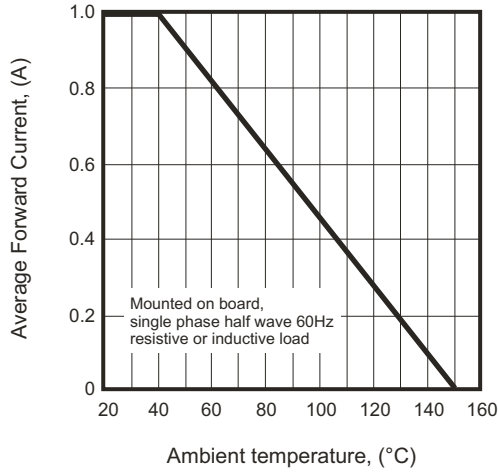

Fig.2 - Maximum Non-Repetitive Surge Current

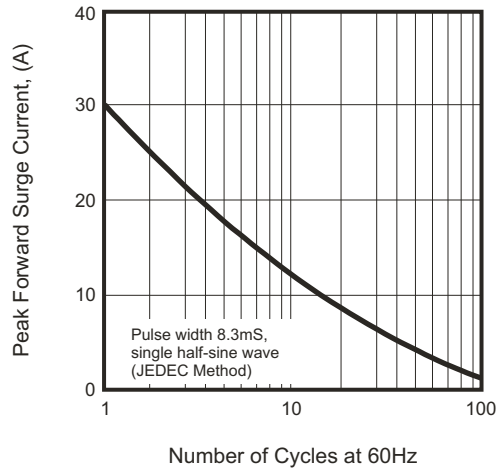
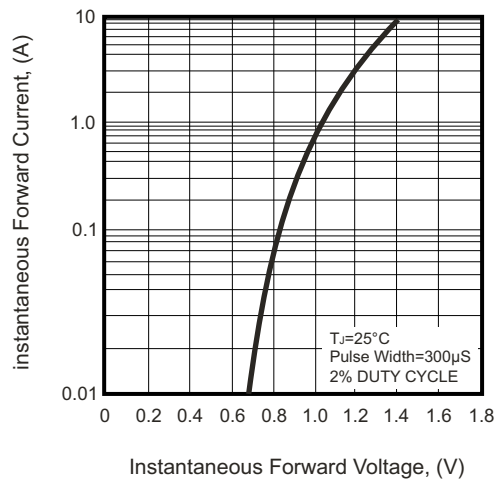

Fig.3 - Typical Reverse Characteristics



Fig.4 - Typical Forward Characteristics



Reel Taping Specification

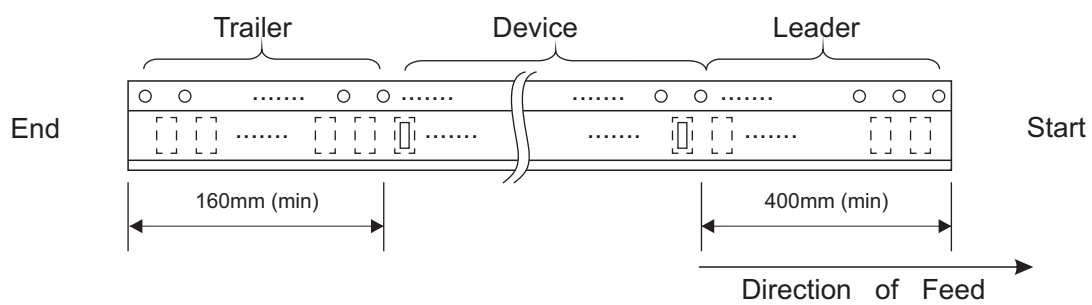
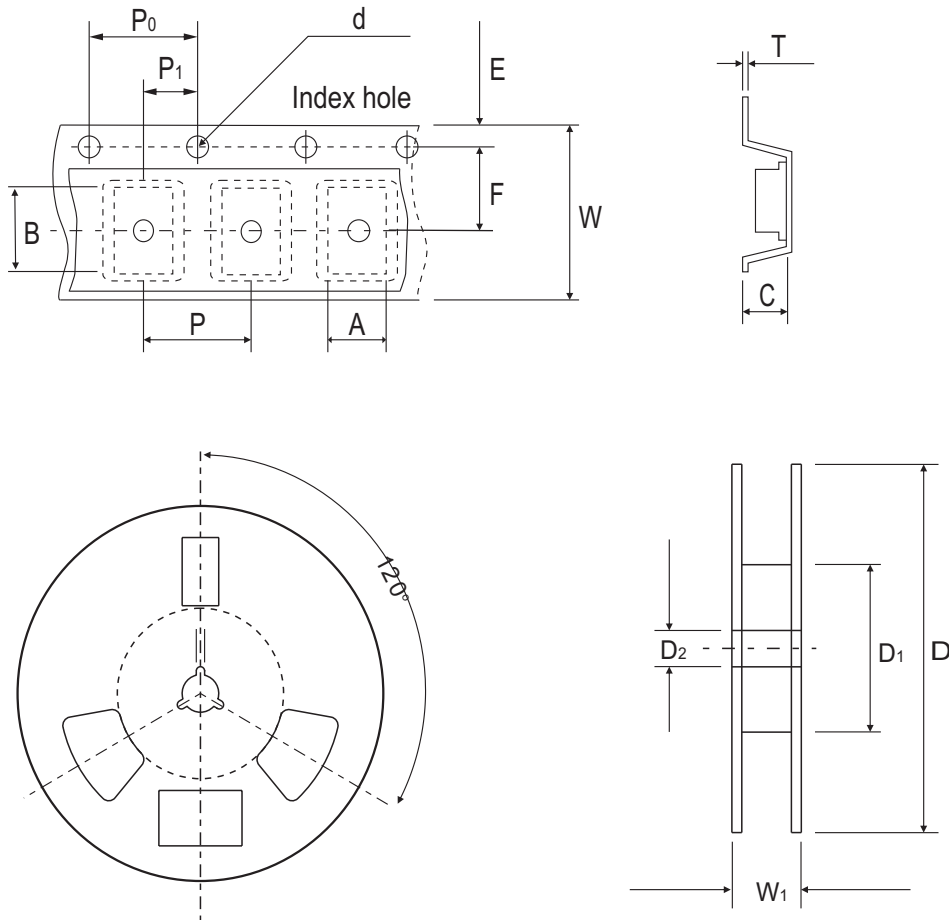

ABS	SYMBOL	A	B	C	d	D	D1	D2
	(mm)	5.31 ± 0.10	6.68 ± 0.10	1.59 ± 0.20	1.55 ± 0.05	330	50.00 (min)	13.00 ± 0.20
	(inch)	0.209 ± 0.004	0.263 ± 0.004	0.063 ± 0.008	0.061 ± 0.002	13.000	1.969 (min)	0.512 ± 0.008

ABS	SYMBOL	E	F	P	P0	P1	T	W	W1
	(mm)	1.75 ± 0.10	5.50 ± 0.05	8.00 ± 0.10	4.00 ± 0.10	2.00 ± 0.05	0.30	12.00 ± 0.30	12.00~14.40
	(inch)	0.069 ± 0.004	0.217 ± 0.002	0.315 ± 0.004	0.157 ± 0.004	0.079 ± 0.002	0.012	0.472 ± 0.012	0.472~0.657

Company reserves the right to improve product design, functions and reliability without notice.

REV: D

Marking Code

Part Number	Marking code
ABS05-HF	ABS05
ABS1-HF	ABS1
ABS2-HF	ABS2
ABS4-HF	ABS4
ABS6-HF	ABS6
ABS8-HF	ABS8
ABS10-HF	ABS10

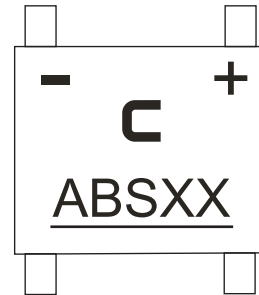

XX = Product type marking code

Suggested PAD Layout

SIZE	ABS	
	(mm)	(inch)
A	0.80 Min	0.031 Min
B	4.00 REF	0.157 REF
C	0.60 Min	0.024 Min
D	6.20 Max	0.244 Max



Standard Packaging

Case Type	REEL PACK	
	REEL (pcs)	Reel Size (inch)
ABS	5,000	13

Mouser Electronics

Authorized Distributor

Click to View Pricing, Inventory, Delivery & Lifecycle Information:

[Comchip Technology:](#)

[ABS6-HF](#) [ABS10-HF](#)