

EXCELSYS XSOLO

ULTRA-COMPACT, HIGH-EFFICIENCY 500 W AND 1000 W SINGLE OUTPUT POWER SUPPLIES

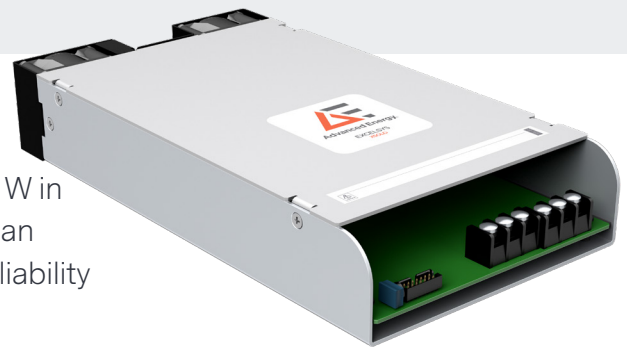

Advanced Energy's Xsolo series, part of our Excelsys product line, delivers an incredible convection-cooled 504 W in an open-frame U-channel form factor and up to 1008 W in an enclosed, fan-cooled chassis. This high-efficiency, high-reliability product is available in two compact package types.

PRODUCT HIGHLIGHTS

- Single output voltages are 24 V, 36 V, or 48 V with wide adjustment ranges and user-defined set-points
- Ultra high efficiency, > 92%
- Low profile: 1U height (40 mm)
- Convection-cooled 500 W
- Fan-cooled 1000 W (variable speed fan)
- 12 V/300 mA bias standby voltage provided
- Remote ON/OFF signal
- Power Good signal
- Suitable for type B-rated applications
- Optional PMBus™ communications
- Optional OR-ing function
- Five-year warranty
- Adjustable output voltage control

- 5000 m altitude for EN60950 applications
- All models feature active power factor correction as standard
- Product options: Conformal coating, low leakage current and ruggedized

TYPICAL APPLICATIONS

- Industrial
- Test and measurement
- Acoustically sensitive laboratory and medical environments
- Hi-Rel MIL-COTS
- Communication

AT A GLANCE

	XS500	XS1000
Power	504 W	1008 W
Output Voltage	24, 36, 48	24, 36, 48

Certifications

- IEC60601-1 2nd and 3rd edition
- IEC60601-1-2 4th edition (EMC)
- IEC60950 2nd edition
- 2 MOPP
- SEMI F47
- MIL-STD-810G²

MODELS

Model	Power (W)	Output Voltage	Output Current (A)	Medical Approval UL/EN60601-1, 3rd Edition	Industrial Approval UL/EN60950, 2nd Edition
XS500-24	504	24	21.0	Yes	Yes
XS1000-24	1008	24	42.0	Yes	Yes
XS500-36	504	36	14.0	Yes	Yes
XS1000-36	1008	36	28.0	Yes	Yes
XS500-48	504	48	10.5	Yes	Yes
XS1000-48	1008	48	21.0	Yes	Yes

Model	Vnom (W)	Description	Set Point Adjust Range (V)	Dynamic Vtrim Range (V)	I _{max} (A)	Remote Sense	Power Good
XS500-24	24	Convection-cooled U-channel	19-28	14-28	21.0	Yes	Yes
XS1000-24	24	Enclosed fan-cooled	19-28	14-28	42.0	Yes	Yes
XS500-36	36	Convection-cooled U-channel	26-40	20-40	14.0	Yes	Yes
XS1000-36	36	Enclosed fan-cooled	26-40	20-40	28.0	Yes	Yes
XS500-48	48	Convection-cooled U-channel	36-58	29-58	10.5	-	Yes
XS1000-48	48	Enclosed fan-cooled	36-58	29-58	21.0	Yes	Yes

ELECTRICAL SPECIFICATIONS

Input						
Parameter	Conditions/Description	Min	Nom	Max	Units	
Input Voltage Range	Universal input 47-440 Hz	85	—	264	VAC	
	—	120	—	380	VDC	
Power Rating	XS500	—	504	—	W	
	XS1000	—	1008	—	W	
Input Current	XS500	—	5	—	A	
	XS1000	—	10	A	—	
Inrush Current	230 VAC @ 25°C	—	—	25	A	
Undervoltage Lockout	Shutdown	65	—	74	VAC	
Fusing	XS500 250 VAC	—	F8A HRC	—	—	
	XS1000 250 VAC	—	F12A HRC	—	—	

Output						
Parameter	Conditions/Description	Min	Nom	Max	Units	
Output Voltage Range	XS500/1000-24: Multi-turn potentiometer	19	—	28	VDC	
	XS500/1000-24: Dynamic Vtrim range	14	—	28	VDC	
	XS500/1000-36: Multi-turn potentiometer	26	—	40	VDC	
	XS500/1000-36: Dynamic Vtrim range	20	—	40	VDC	
	XS500/1000-48: Multi-turn potentiometer	36	—	58	VDC	
	XS500/1000-48: Dynamic Vtrim range	29	—	58	VDC	

ELECTRICAL SPECIFICATIONS (CONTINUED)

Output (Continued)					
Parameter	Conditions/Description	Min	Nom	Max	Units
Output Current Range	XS500-24	—	—	21	A
	XS1000-24	—	—	42	A
	XS500-36	—	—	14	A
	XS1000-36	—	—	28	A
	XS500-48	—	—	10.5	A
	XS1000-48	—	—	21	A
Load and Cross Regulation	For 25% to 75% load change	—	—	±0.2	%
	ORing option	—	—	±0.4	%
Transient Response	For 25% to 75% load change voltage deviation	—	—	2.5	%
	Settling time	—	—	500	µs
Ripple and Noise	XS500/1000-24: 20 MHz	—	240mV	—	pk-pk
	XS500/1000-36: 20 MHz	—	360 mV	—	pk-pk
	XS500/1000-48: 20 MHz	—	480 mV	—	pk-pk
Overvoltage Protection	XS500/1000-24: Latching	33	34	37	VDC
	XS500/1000-36: Latching	44	47	52	VDC
	XS500/1000-48: Latching	61	63	69	VDC
Overcurrent Protection	Straight line with hiccup activation at < 30% of Vnom.	105	115	130	%
Line Regulation	For ±10% change from nominal line	—	±0.5	—	%
Remote Sense	—	—	—	0.5	VDC
Overshoot	—	—	—	2	%
Rise Time	Monotonic	—	3	5	ms
Turn-On Delay	From AC in	—	500	800	ms
	From remote On/Off	—	10	—	ms
Hold-Up Time	For nominal output voltages at full load.	17	—	—	ms

General					
Parameter	Conditions/Description	Min	Nom	Max	Units
Isolation Voltage	Input to output	4000	—	—	VAC
	Input to chassis	1500	—	—	VAC
	Output to chassis	1500	—	—	VAC
Efficiency	230 VAC, 1008 W @ 24 V/36 V/48 V	—	> 92	—	%
Safety Agency Approvals	EN60601-1 2nd and 3rd Edition, cTUVus 60601-1	—	—	—	—
	EN60950 2nd Edition, cTUVus 60950	—	—	—	—
Leakage Current	264 VAC, 60 Hz, 25°C	—	—	300	µA
	264 VAC, 60 Hz, 25°C (Option 4)	—	—	150	µA
Signals	See the designer's manual	—	—	—	—
Bias Supply	Always on, current 300 mA XS1000, 50 mA XS500	—	12.0	—	VDC
Weight	XS500	—	1.1	—	Kg
	XS1000	—	1.3	—	Kg
MTBF	Telecordia SR-332, 40°C ground benign, parts count	—	—	550,000	Hours

ELECTRICAL SPECIFICATIONS (CONTINUED)

EMC		
Parameter	Standard	Level
Emissions		
Conducted	EN55011, EN55022, FCC	Class B
Radiated	EN55011, EN55022, FCC	Class B
Harmonic Distortion	EN61000-3-2 Class A	Compliant
Flicker and Fluctuation	EN61000-3-3	Compliant
Immunity		
Electrostatic Discharge	EN61000-4-2	Level 2
Radiated Immunity	EN61000-4-3	Level 3
Fast Transients-Burst	EN61000-4-4	Level 3
Input Line Surges	EN61000-4-5	Level 3
Conducted Immunity	EN61000-4-6	Level 3
Voltage Dips	EN61000-4-11, SEMI F47 compliant*	Compliant

Environmental					
Parameter	Conditions/Description	Min	Nom	Max	Units
Operating Temperature	-40	—	+70	—	°C
Storage Temperature	-40	—	+85	—	°C
Derating	See the designer's manual for full temperature deratings	—	—	—	—
Relative Humidity	Non-condensing	5	—	95	%RH
Shock and Vibration	Designed to meet MIL810 G ²	—	55	—	G
Altitude	EN60601-1 Operational: 3000 m, Storage 8000 m	—	3000	—	m
	EN60950 Operational: 5000 m, Storage 8000 m	—	5000	—	m

Derating Curves

The line voltage and temperatures derating curves for the XS500 and XS1000 are shown below. The XS500 is a 500 W convection-cooled part. The graphs below show the output power ratings with no system air flow and with 10 CFM of system air flow applied to the product.

Contact Advanced Energy for further information on the XS500 and XS1000 performance with system air flow applied to the product.

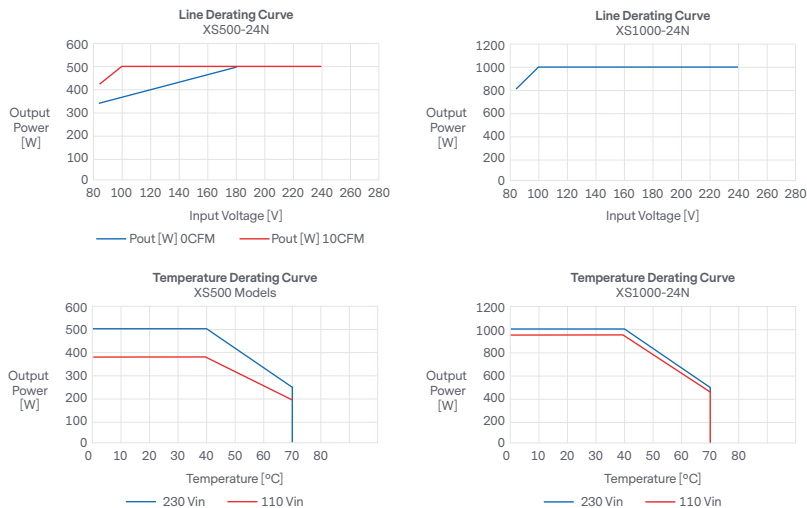

INTERFACE

Input Connector J7

Connector, Barrier Terminal Block, Vertical, 3 position, Pitch: 0.375 in Molex — 38720-7503

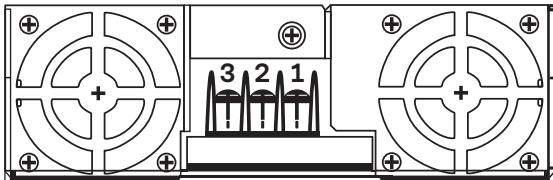

O/P Connector J10 and J12

Connector, Barrier STRIP DL 3CIRC .325 Tyco — 2-1437667-5

*Note: Maximum current per screw terminal is 20 Amps

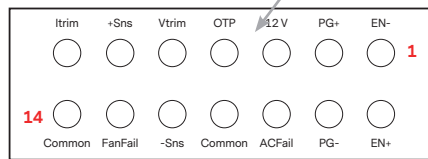
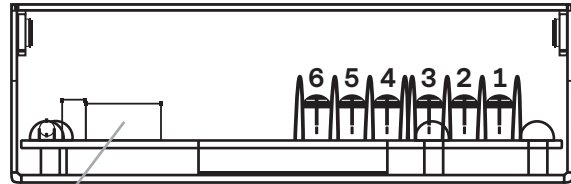

Output Signal Connector J5

Connector, Header 14POS 2MM Pitch T/H Molex — 87831-1420

J5 Mating Connectors

Locking Molex 51110-1451;
Non Locking 51110-1450;
Crimp Terminal: Molex p/n 50394

I²C Interface (Option)

The PMBus™ compatible interface can be used for monitoring the output voltage and current. It can also be used to manage real time data for the PSU. For full details on PMBus™ please contact Advanced Energy.

PMBus™ Connector

PL1: Molex — 87833-0831

PL1 Mating Connector

Locking Molex 51110-0860;
Non Locking 51110-0850;
Crimp Terminal: Molex p/n 50394

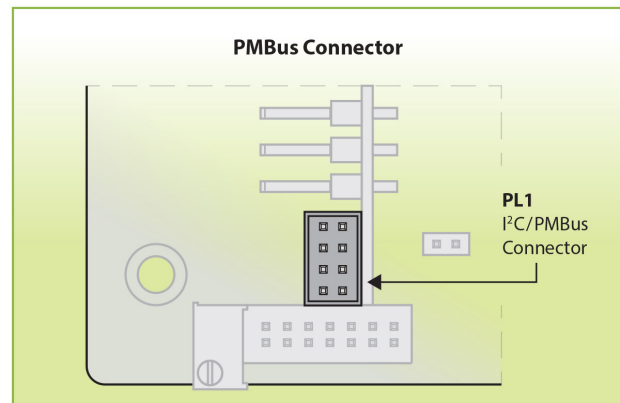

Connector Details				
Pin	Input	Output	Signal	PMBus Connector
1	L	+Vo	EN-	Not Used
2	N	+Vo	EN+	GND
3	PE	+Vo	PG+	Not Used
4	—	-Vo	PG-	Not Used
5	—	-Vo	12V	SCL
6	—	-Vo	ACFail	Not Used
7	—	—	OTP	Not Used
8	—	—	Common	SDA
9	—	—	Vtrim	—
10	—	—	-Sns	—
11	—	—	+Sns	—
12	—	—	FanFail	—
13	—	—	Itrim	—
14	—	—	Common	—

XSOLO SERIES

Paralleling Xsolo Products

To achieve increased currents Xsolo products can be paralleled. To connect in parallel the outputs must be trimmed to within 5 mV of each other and then the current share header J20 must be added to each Xsolo product.

- Recommended Jumper for J20: HARWIN M7567-05
- (Jumper Socket, Black, 2.54 mm, 2-way)

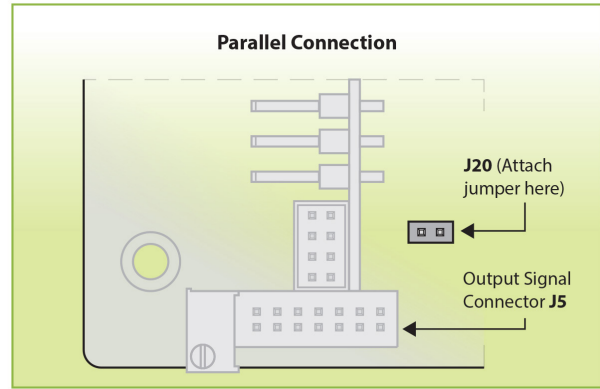

MECHANICAL SPECIFICATIONS

XS500-24

(All dimensions in mm)

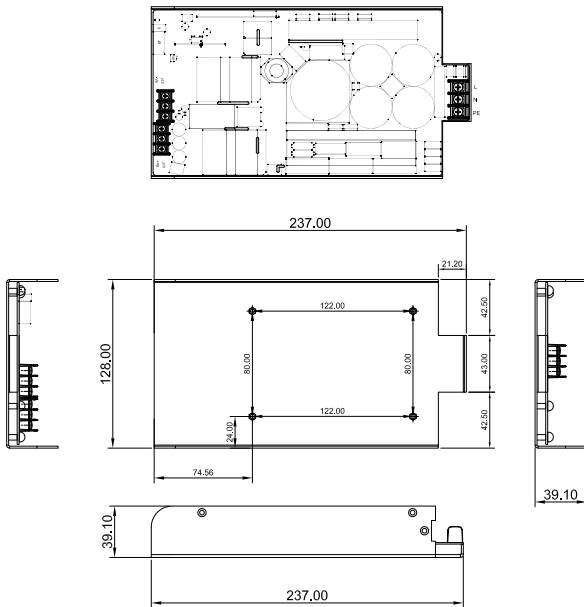

Mounting Holes

4 M4 threaded PEMS on Base, Max Screw Penetration is 6 mm from Base

NOTES

- ¹ SEMI F47 compliant at input voltages > 160 VAC. Consult Advanced Energy for details.
- ² Consult Advanced Energy for MIL810G report (enhanced ruggedisation available as an option).
- ³ System design with low leakage capacitors requires particular attention to EMI. Please consult Advanced Energy for application details.
- ⁴ Contact Advanced Energy for details including MOQs on alternative preset output voltages.
- ⁵ The specifications contained herein are believed to be correct at time of publication and are subject to change without notice.
- ⁶ All specifications at nominal input, full load, 25°C unless otherwise stated.
- ⁷ Compliance with MIL-STD-461 (CE101 & CE102) achieved with the addition of an external line filter from LCR p/n F19374.
- ⁸ Product is not UL/EN certified for 120-380 VDC input operation. Consult Advanced Energy for details.
- ⁹ Above 2000 m altitude, ambient operating temperature decreases by 1°C per 305 m (1000 ft) altitude increase

XS1000-24

(All dimensions in mm)

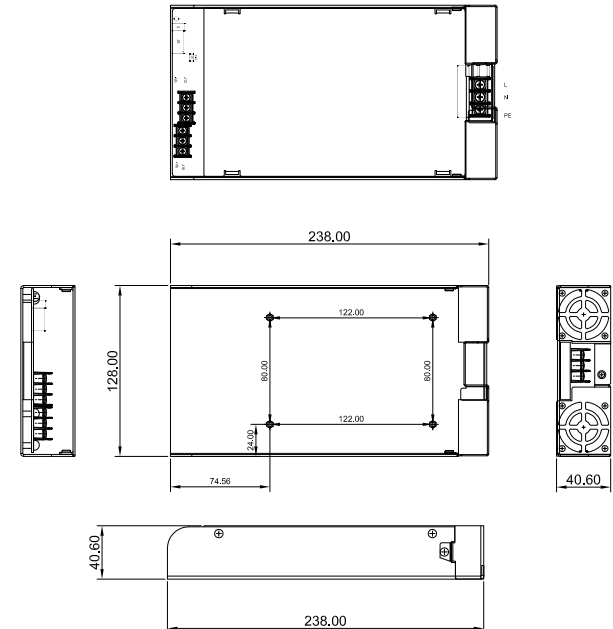

Mounting Holes

4 M4 threaded PEMS on Base, Max Screw Penetration is 6 mm from Base

CONFIGURATION

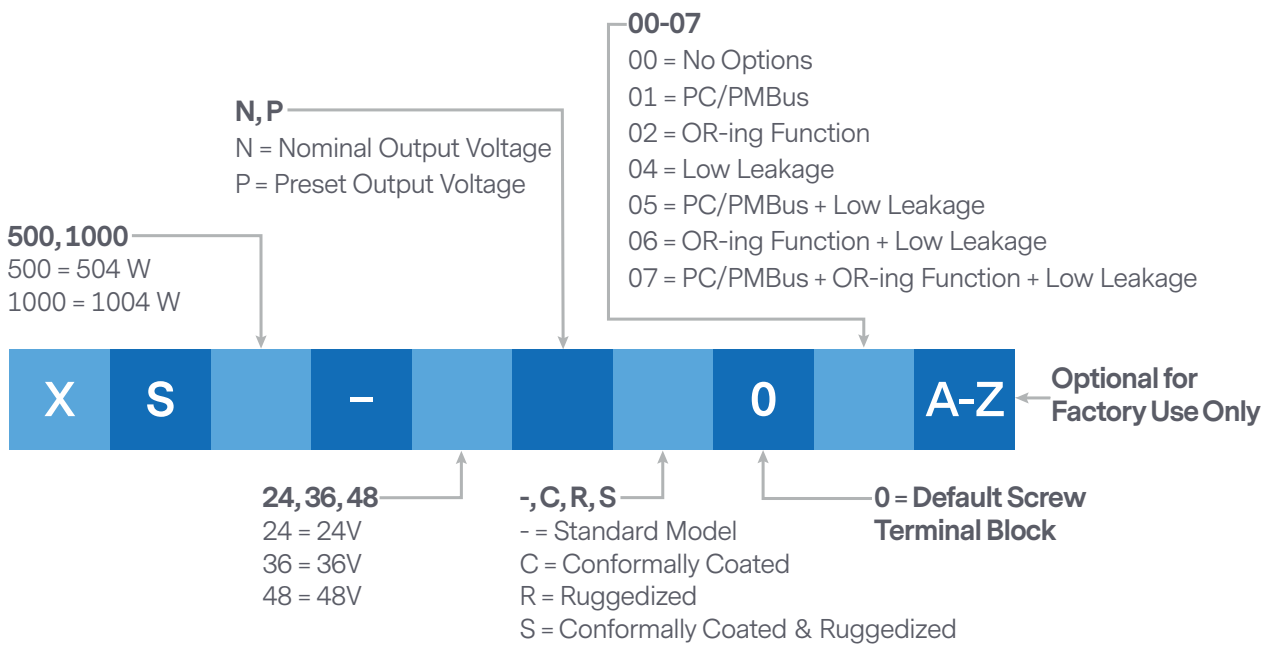

Example 1: XS1000-24N-000 = Xsolo 1000 W, 24 V, output with no options

Example 2: XS1000-24N-003 = Xsolo 1000 W, 24 V, output with PC/PMBus and OR-ing function



For international contact information,
visit advancedenergy.com

ABOUT ADVANCED ENERGY

Advanced Energy (AE) has devoted more than three decades to perfecting power for its global customers. AE designs and manufactures highly engineered, precision power conversion, measurement and control solutions for mission-critical applications and processes.

Our products enable customer innovation in complex applications for a wide range of industries including semiconductor equipment, industrial, manufacturing, telecommunications, data center computing, and medical. With deep applications know-how and responsive service and support across the globe, we build collaborative partnerships to meet rapid technological developments, propel growth for our customers, and innovate the future of power.

PRECISION | POWER | PERFORMANCE

Specifications are subject to change without notice. Not responsible for errors or omissions. ©2020 Advanced Energy Industries, Inc. All rights reserved. Advanced Energy® and AE® are U.S. trademarks, and CoolX® is a U.S. and European trademark of Advanced Energy Industries, Inc.



Mouser Electronics

Authorized Distributor

Click to View Pricing, Inventory, Delivery & Lifecycle Information:

[Advanced Energy:](#)

[XS1000-48N-004](#) [XS1000-24N-002](#) [XS1000-24N-004](#) [XS1000-48N-000](#) [XS1000-24N-001](#) [XS1000-48N-002](#)
[XS1000-48N-001](#) [XS1000-24N-000](#) [XS1000-36N-000](#) [XS500-48N-000](#) [XS500-36N-000](#) [XS500-24N-000](#) [XS1000-24N-006](#) [XS1000-36N-002](#) [XS1000-24N-003](#) [XS1000-48N-004](#) [XS1000-36N-006](#) [XS1000-36N-007](#) [XS1000-48N-003](#) [XS1000-48N-005](#) [XS1000-48N-006](#) [XS1000-48N-007](#) [XS1000-24N-005](#) [XS1000-24N-007](#) [XS1000-36N-001](#)
[XS1000-36N-003](#) [XS1000-36N-004](#) [XS1000-36N-005](#)