

850nm Dual Junction Infrared LED Emitter

LZ1-00R602

Key Features

- 850nm Dual Junction Infrared LED
- Ultra-small foot print – 4.4mm x 4.4mm
- Surface mount ceramic package with integrated glass lens
- Very low Thermal Resistance (6.0°C/W)
- Very high Radiant Flux density
- JEDEC Level 1 for Moisture Sensitivity Level
- Lead (Pb) free and RoHS compliant
- Reflow solderable
- Emitter available on Standard or Miniature MCPCB (optional)

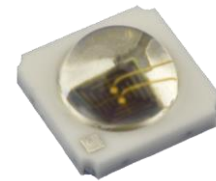

Typical Applications

- Surveillance cameras
- Traffic management
- Gesture recognition
- Machine vision
- Biometric sensing

Description

The LZ1-00R602 850nm Dual Junction Infrared LED emitter generates 1150mW nominal output at 3.2W power dissipation in an extremely small package. With a 4.4mm x 4.4mm ultra-small footprint, this package provides exceptional radiant flux density. The patent-pending design has unparalleled thermal and optical performance. The high quality materials used in the package are chosen to optimize optical performance and minimize stresses which results in monumental reliability and flux maintenance. The robust product design thrives in outdoor applications with high ambient temperatures and high humidity.

Notes

This product emits non visible infrared light, which can be hazardous depending on total system configuration (including, but not limited to optics, drive current and temperature). Observe safety precaution given in IEC 62471 when operating this product.

Part number options

Base part number

Part number	Description
LZ1-00R602	LZ1 Infrared 850nm Dual Junction Emitter
LZ1-10R602	LZ1 Infrared 850nm Dual Junction Emitter on Standard Star MCPCB

Bin kit option codes

R6, Infrared Dual Junction (850nm)			
Kit number suffix	Min flux Bin	Wavelength Bin Range	Description
0000	L44M	F08	full distribution flux; full distribution wavelength

Notes:

1. Default bin kit option is -0000

Radiant Flux Bins

Table 1:

Bin Code	Minimum Radiant Flux (Φ) @ $I_F = 1000\text{mA}$ ^[1,2] (mW)	Maximum Radiant Flux (Φ) @ $I_F = 1000\text{mA}$ ^[1,2] (mW)
L44M	950	1250
N	1250	1600

Notes for Table 1:

1. Radiant flux performance is measured at 10ms pulse, $T_c = 25^\circ\text{C}$. LED Engin maintains a tolerance of $\pm 10\%$ on flux measurements.
2. Future products will have even higher levels of radiant flux performance. Contact LED Engin Sales for updated information.

Peak Wavelength Bin

Table 2:

Bin Code	Minimum Peak Wavelength (λ_p) @ $I_F = 1000\text{mA}$ ^[1] (nm)	Maximum Peak Wavelength (λ_p) @ $I_F = 1000\text{mA}$ ^[1] (nm)
F08	835	875

Notes for Table 3:

1. Peak wavelength is measured at 10ms pulse, $T_c = 25^\circ\text{C}$. LED Engin maintains a tolerance of $\pm 2.0\text{nm}$ on peak wavelength measurements.

Forward Voltage Bin

Table 3:

Bin Code	Minimum Forward Voltage (V_f) @ $I_F = 1000\text{mA}$ ^[1] (V)	Maximum Forward Voltage (V_f) @ $I_F = 1000\text{mA}$ ^[1] (V)
0	2.7	3.7

Notes for Table 3:

1. Forward voltage is measured at 10ms pulse, $T_c = 25^\circ\text{C}$. LED Engin maintains a tolerance of $\pm 0.04\text{V}$ for forward voltage measurements.

Absolute Maximum Ratings

Table 4:

Parameter	Symbol	Value	Unit
DC Forward Current at $T_{J(MAX)}=120^{\circ}C$ ^[1]	I_F	1200	mA
DC Forward Current at $T_{J(MAX)}=145^{\circ}C$ ^[1]	I_F	1000	mA
Peak Pulsed Forward Current ^[2]	I_{FP}	5000	mA
Reverse Voltage	V_R	See Note 3	V
Storage Temperature	T_{stg}	-40 ~ +125	$^{\circ}C$
Junction Temperature	$T_{J(MAX)}$	145	$^{\circ}C$
Soldering Temperature ^[4]	T_{sol}	260	$^{\circ}C$

Notes for Table 4:

- Maximum DC forward current is determined by the overall thermal resistance and ambient temperature. Follow the curves in Figure 11 for current derating.
- Pulse forward current conditions: Pulse Width $\leq 150\mu sec$ and Duty Cycle $\leq 10\%$.
- LEDs are not designed to be reverse biased.
- Solder conditions per JEDEC 020D. See Reflow Soldering Profile Figure 3.
- LED Engin recommends taking reasonable precautions towards possible ESD damages and handling the LZ1-00R602 in an electrostatic protected area (EPA). An EPA may be adequately protected by ESD controls as outlined in ANSI/ESD S6.1.

Optical Characteristics @ $T_C = 25^{\circ}C$

Table 5:

Parameter	Symbol	Typical	Unit
Radiant Flux (@ $I_F = 1000mA$) ^[1]	Φ	1350	mW
Radiant Flux (@ $I_F = 1200mA$) ^[1]	Φ	1600	mW
Wall Plug Efficiency (@ $I_F = 1000mA$)	η	42	%
Peak Wavelength	λ_p	850	nm
Viewing Angle ^[2]	$2\theta_{1/2}$	90	Degrees
Total Included Angle ^[3]	$\theta_{0.9V}$	110	Degrees

Notes for Table 5:

- This product emits non visible infrared light, which can be hazardous depending on total system configuration (including, but not limited to optics, drive current and temperature). Observe safety precaution given in IEC 62471 when operating this product.
- Viewing Angle is the off axis angle from emitter centerline where the radiant power is $\frac{1}{2}$ of the peak value.
- Total Included Angle is the total angle that includes 90% of the total radiant flux.

Electrical Characteristics @ $T_C = 25^{\circ}C$

Table 6:

Parameter	Symbol	Typical	Unit
Forward Voltage (@ $I_F = 1000mA$)	V_F	3.20	V
Forward Voltage (@ $I_F = 1200mA$)	V_F	3.25	V
Temperature Coefficient of Forward Voltage	$\Delta V_F / \Delta T_J$	-2.0	mV/ $^{\circ}C$
Thermal Resistance (Junction to Case)	$R\theta_{J-C}$	6.0	$^{\circ}C/W$

Peak Pulse Forward Current (I_{FP}) Capability

Table 7:

Parameter	Value	Unit
$t_p = 150\mu s, D=10\%$	5000	mA
$t_p = 10ms, D=20\%$	2000	mA

Notes:

- t_p = Pulse Width, T = Period, D = Duty Cycle = t_p/T .

IPC/JEDEC Moisture Sensitivity Level

Table 8 - IPC/JEDEC J-STD-20 MSL Classification:

Level	Floor Life		Soak Requirements			
	Time	Conditions	Standard	Accelerated	Time (hrs)	Conditions
1	Unlimited	$\leq 30^\circ C/$ 60% RH	168 +5/-0	85°C/ 60% RH	n/a	n/a

Notes for Table 7:

- The standard soak time is the sum of the default value of 24 hours for the semiconductor manufacturer's exposure time (MET) between bake and bag and the floor life of maximum time allowed out of the bag at the end user of distributor's facility.

Mechanical Dimensions (mm)

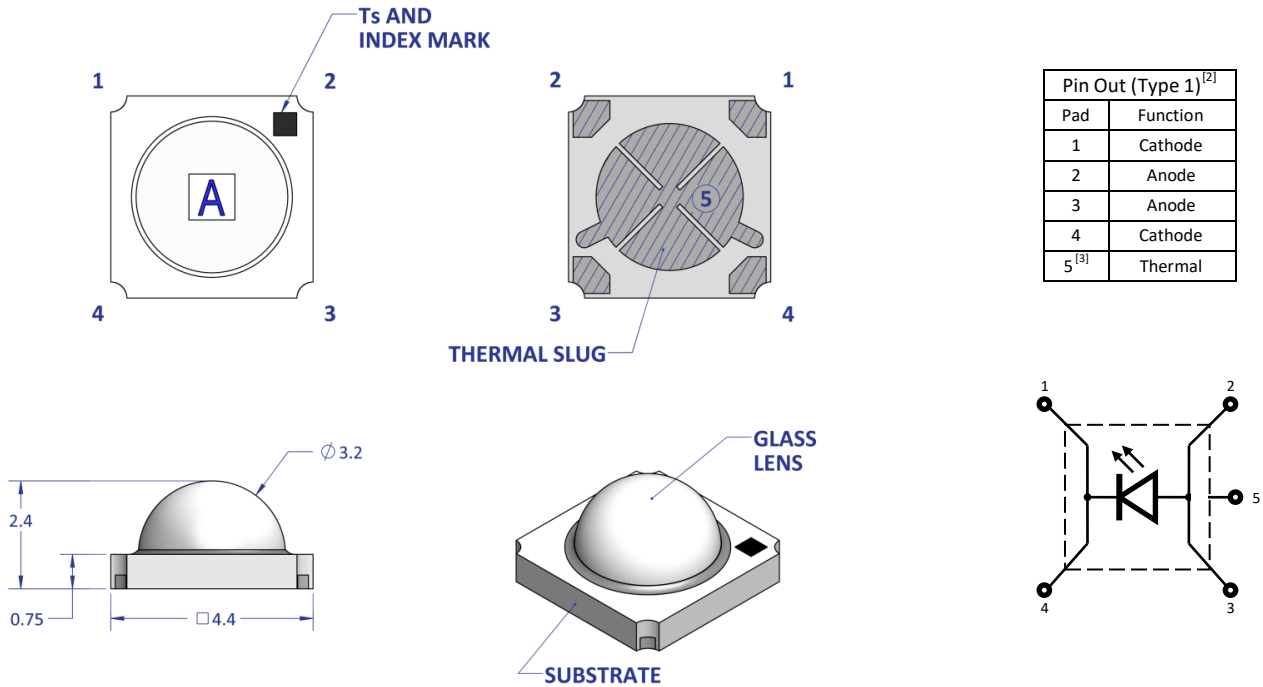

Figure 1: Package outline drawing

Notes for Figure 1:

1. Unless otherwise noted, the tolerance = ± 0.20 mm.
2. This emitter pin-out is reversed to that of LZ1-00B202, LZ1-00G102, LZ1-00A102 and LZ1-00xW02.
3. Thermal contact, Pad 5, is electrically neutral.

Recommended Solder Pad Layout (mm)

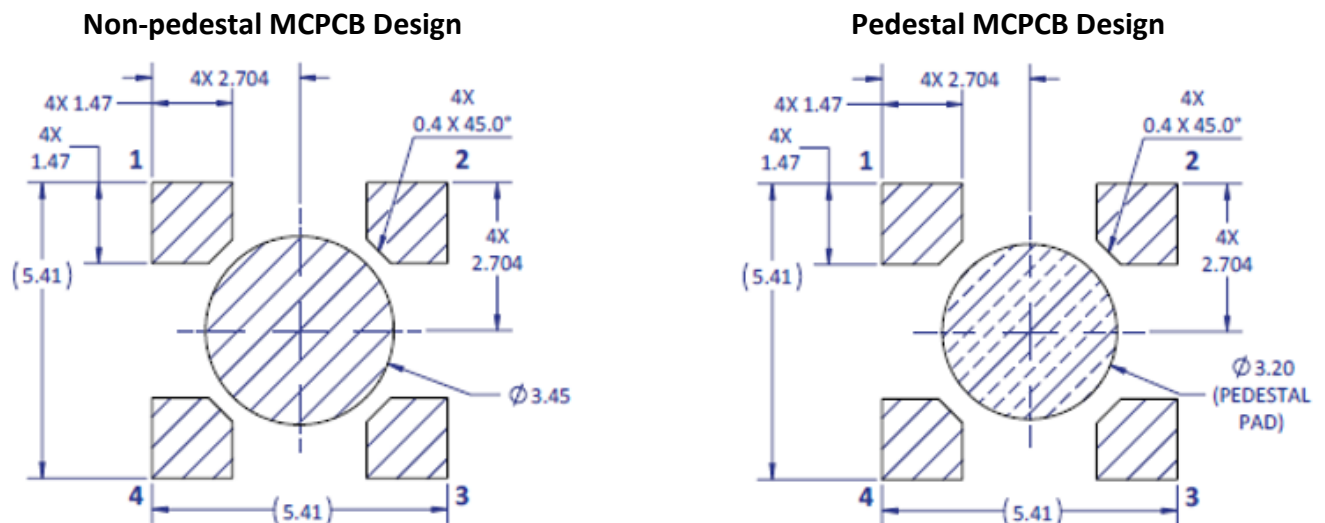

Figure 2a: Recommended solder pad layout for anode, cathode, and thermal pad for non-pedestal and pedestal design.

Note for Figure 2a:

1. Unless otherwise noted, the tolerance = ± 0.20 mm.
2. Pedestal MCPCB allows the emitter thermal slug to be soldered directly to the metal core of the MCPCB. Such MCPCB eliminate the high thermal resistance dielectric layer that standard MCPCB technologies use in between the emitter thermal slug and the metal core of the MCPCB, thus lowering the overall system thermal resistance.
3. LED Engin recommends x-ray sample monitoring for solder voids underneath the emitter solder pins, especially the thermal pad. The total area covered by solder voids should be less than 20% of the total emitter thermal pad area. Excessive solder voids will increase the emitter to MCPCB thermal resistance and may lead to higher failure rates due to thermal over stress.

Reflow Soldering Profile



Figure 3: Reflow soldering profile for lead free soldering.

Typical Radiation Pattern

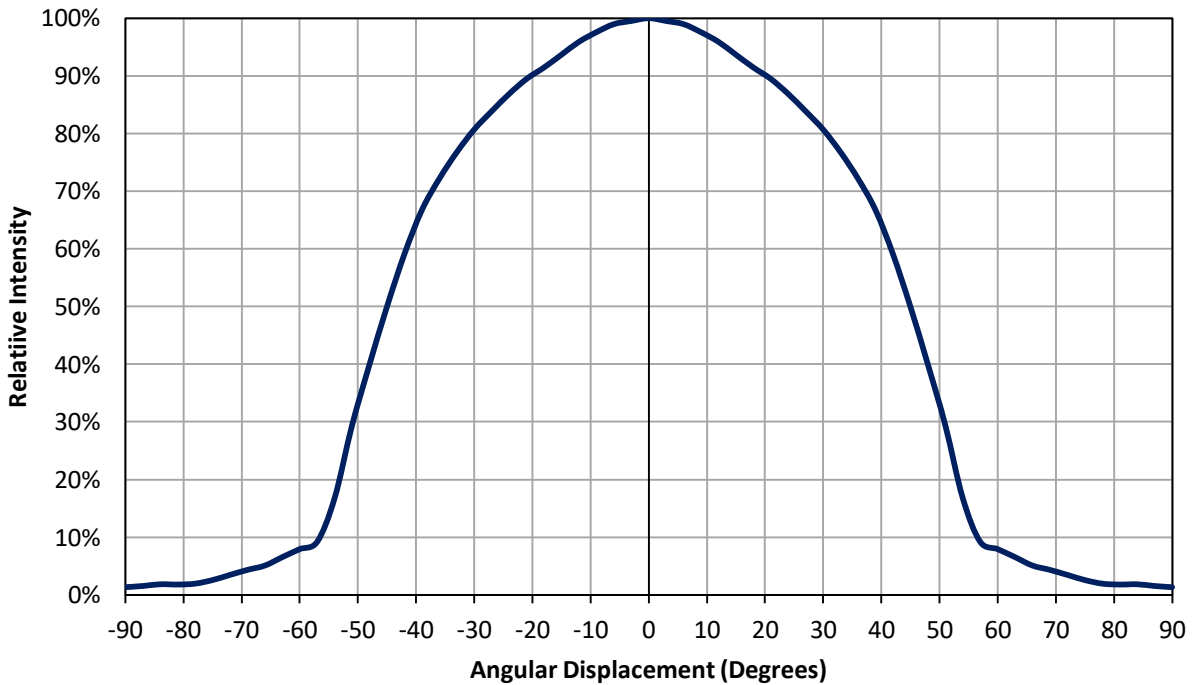

Figure 4: Typical representative spatial radiation pattern.

Typical Relative Spectral Power Distribution

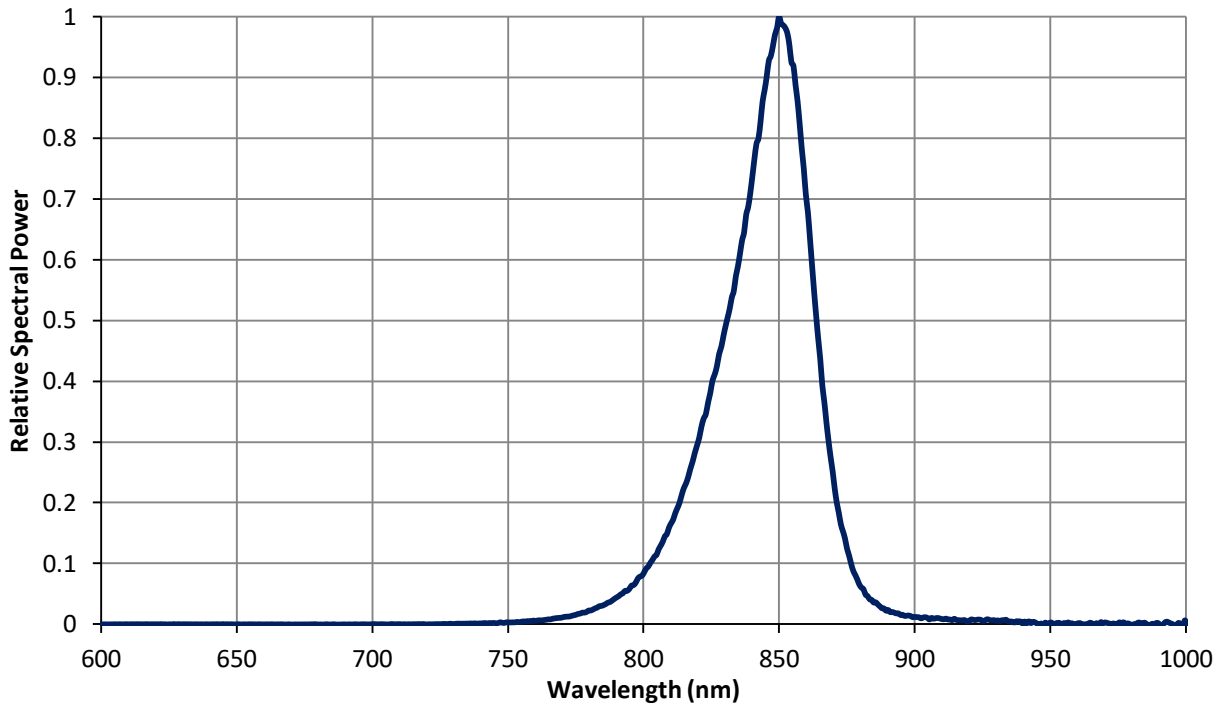

Figure 5: Relative spectral power vs. wavelength @ $T_c = 25^\circ\text{C}$

Typical Forward Current Characteristics

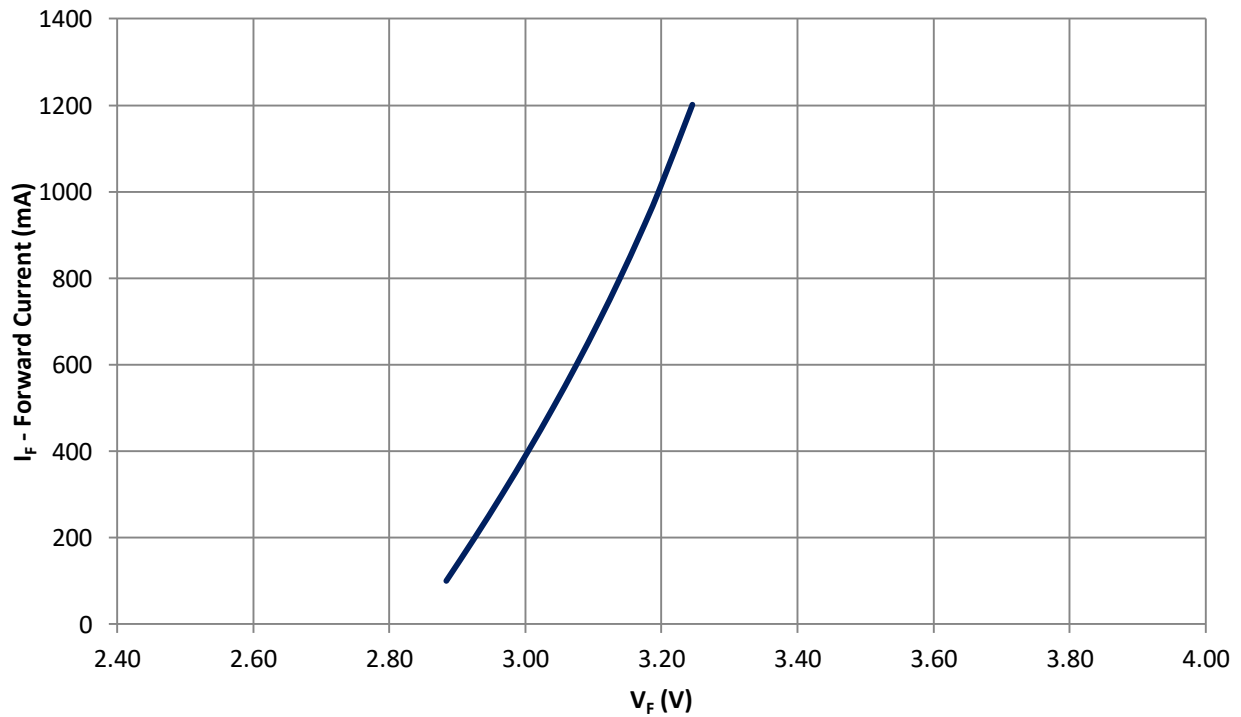

Figure 6: Typical forward current vs. forward voltage @ $T_c = 25^\circ\text{C}$

Typical Normalized Radiant Flux over Current

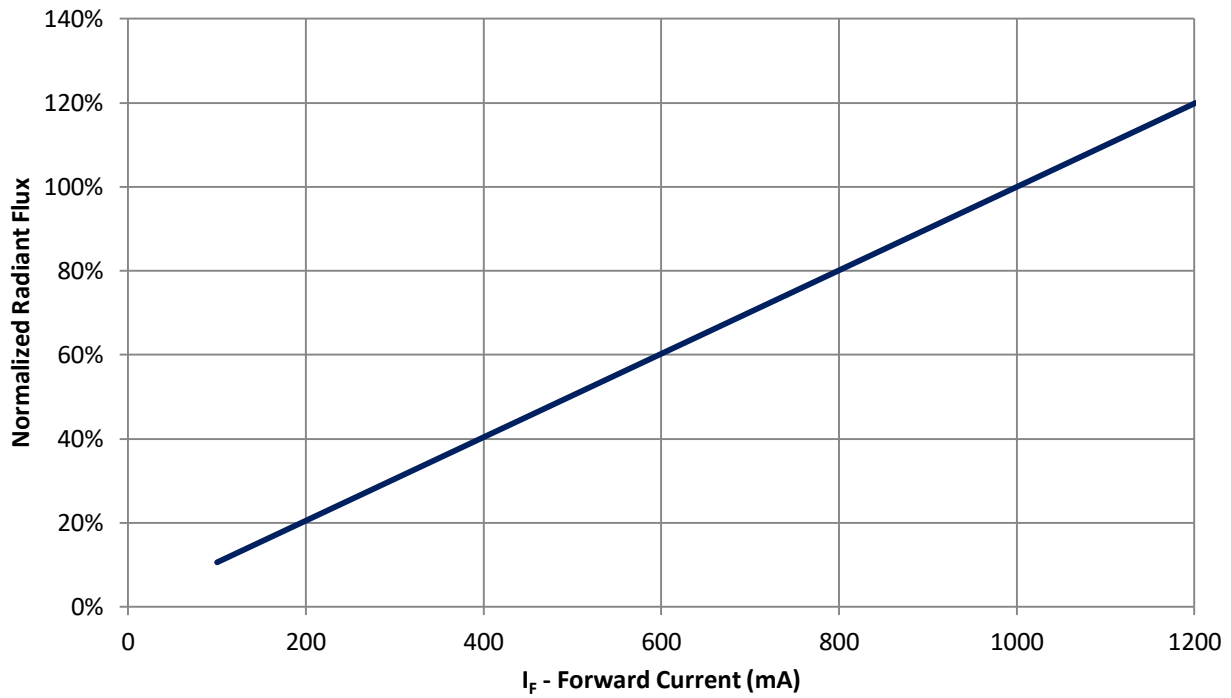

Figure 7: Typical normalized radiant flux vs. forward current @ $T_C = 25^\circ\text{C}$

Typical Normalized Radiant Flux over Case Temperature

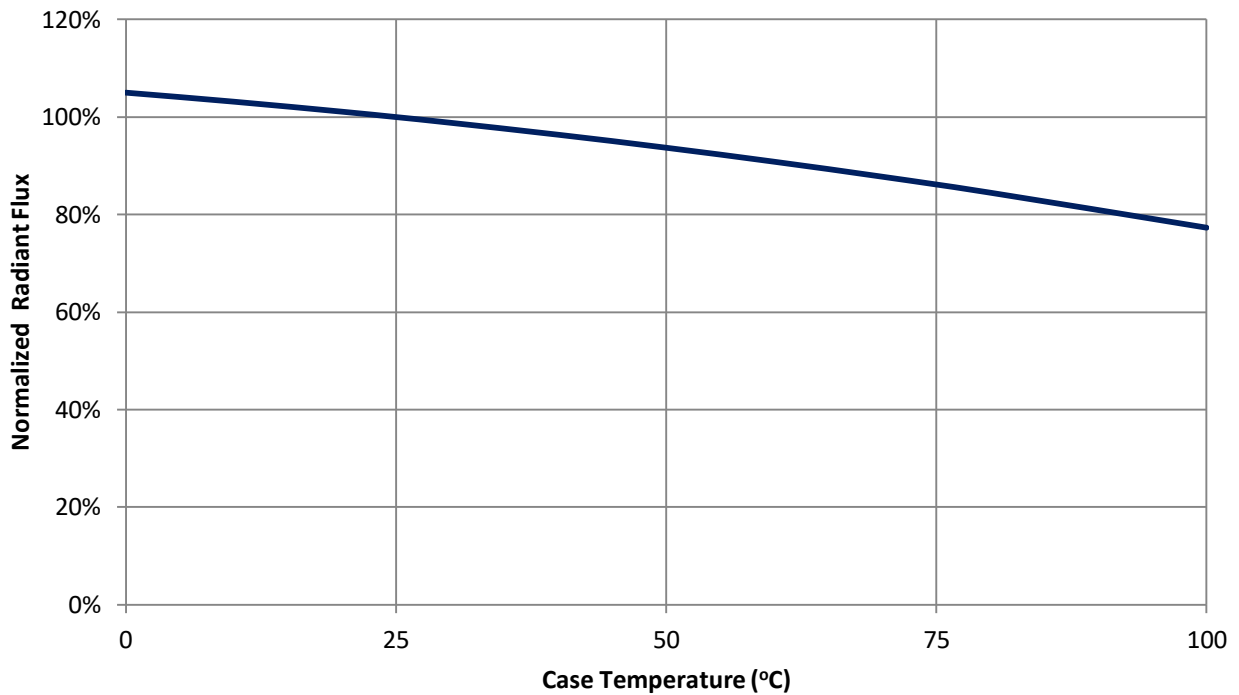

Figure 8: Typical normalized radiant flux vs. case temperature

Typical Peak Wavelength Shift over Current

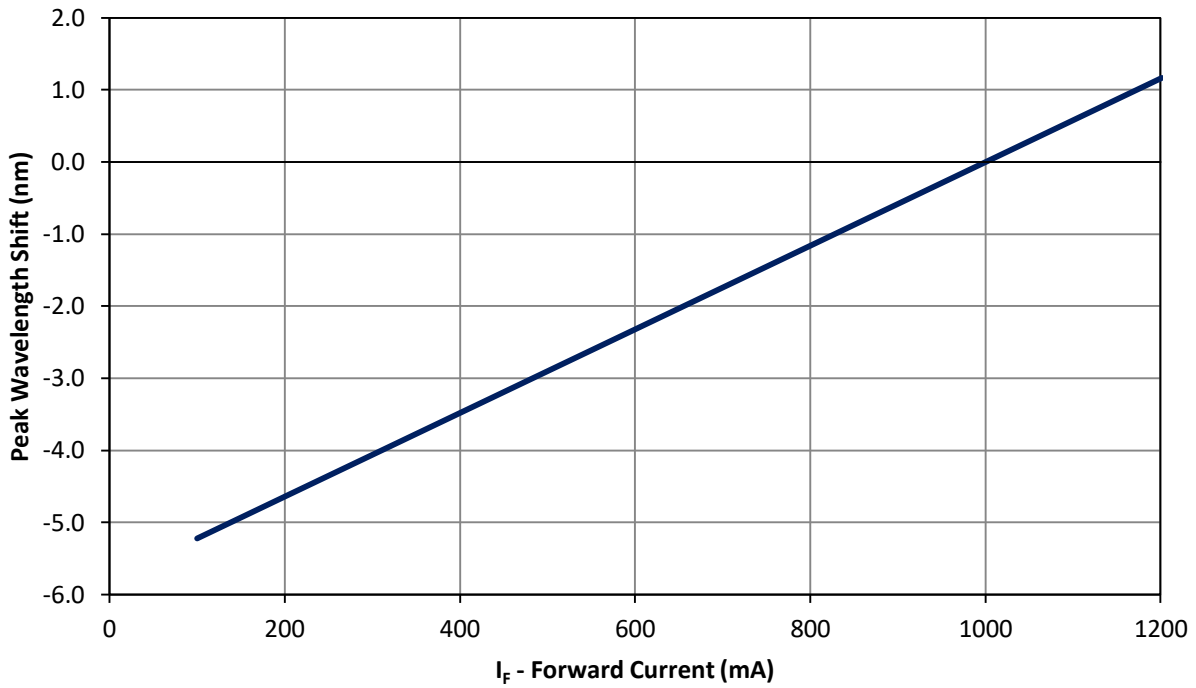

Figure 9: Typical peak wavelength shift vs. forward current @ Tc = 25°C

Typical Peak Wavelength Shift over Case Temperature

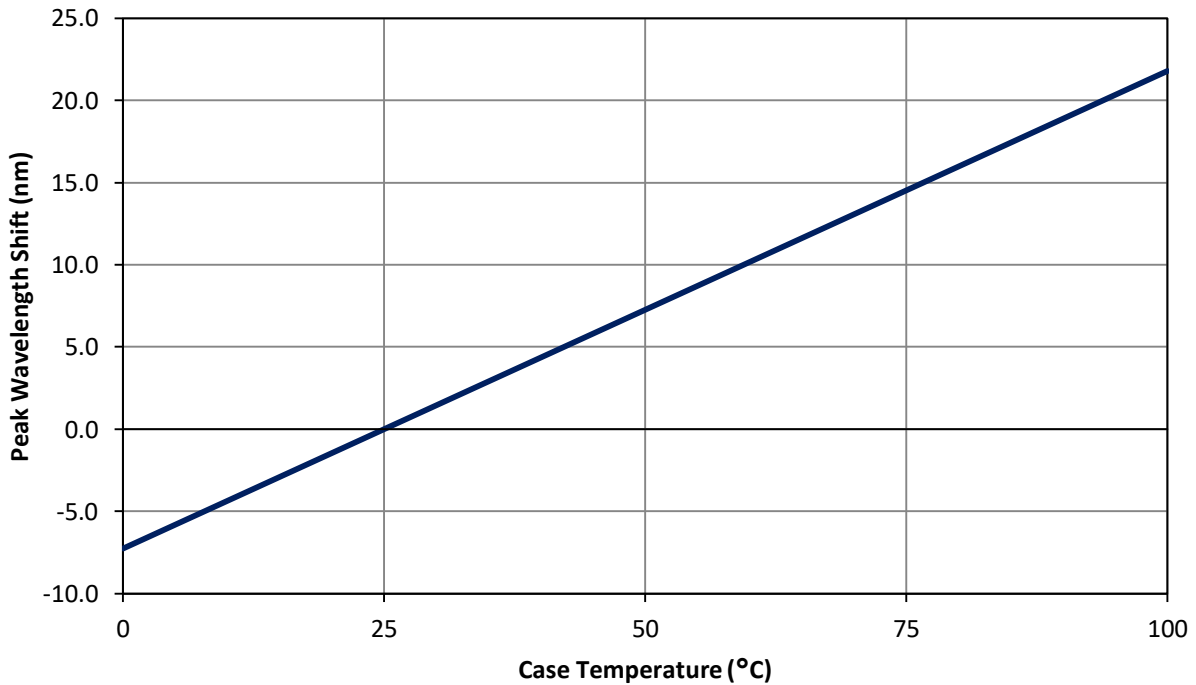

Figure 10: Typical peak wavelength shift vs. case temperature

Current De-rating

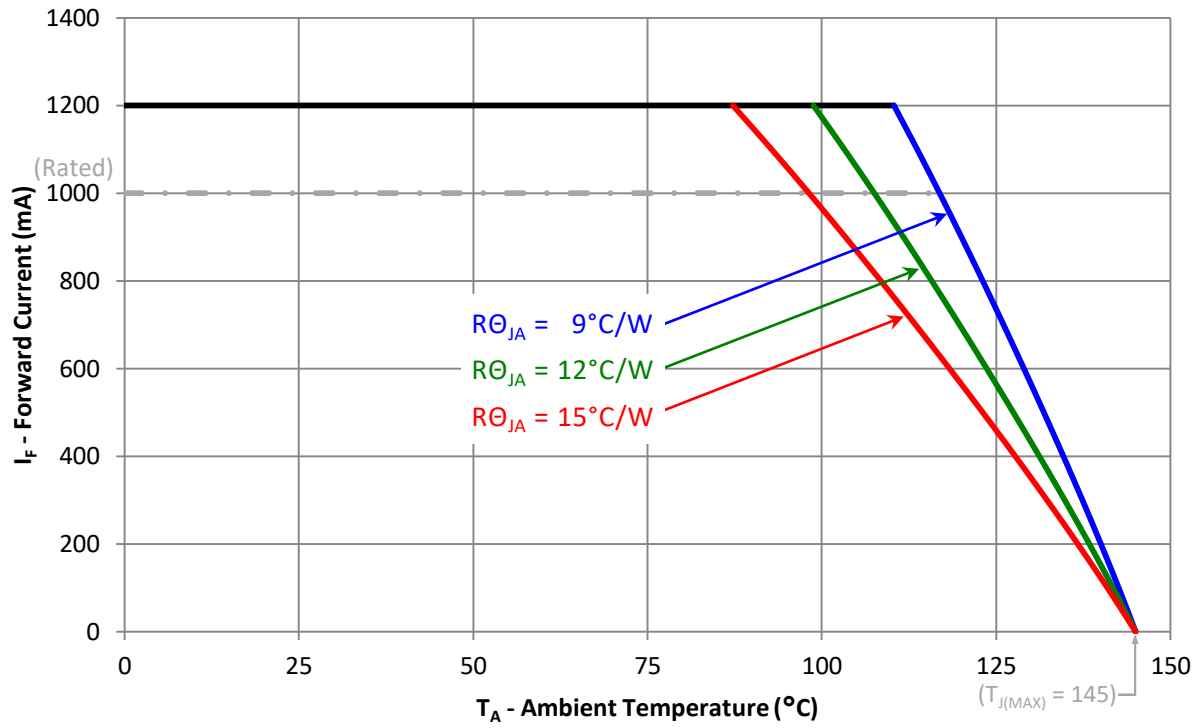

Figure 11: Maximum forward current vs. ambient temperature based on $T_{J(MAX)} = 145^\circ\text{C}$.

Notes for Figure 11:

1. $R\theta_{J-C}$ [Junction to Case Thermal Resistance] for the LZ1-00R602 is typically 6.0°C/W .
2. $R\theta_{J-A}$ [Junction to Ambient Thermal Resistance] = $R\theta_{J-C} + R\theta_{C-A}$ [Case to Ambient Thermal Resistance].

Emitter Tape and Reel Specifications (mm)

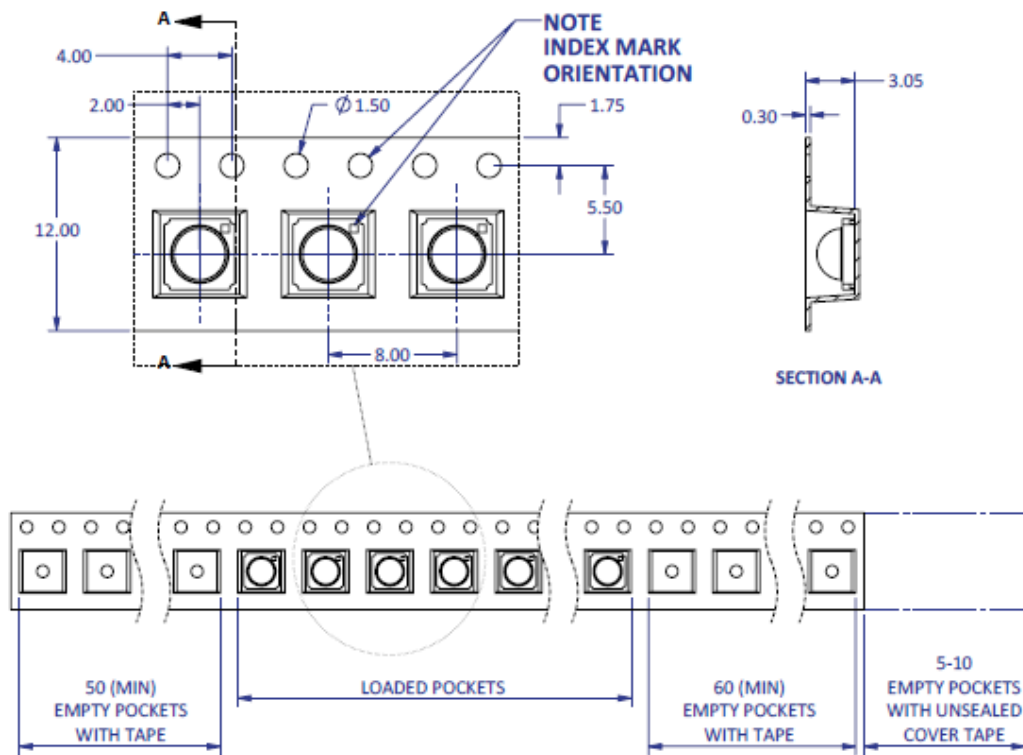

Figure 12: Emitter carrier tape specifications (mm).

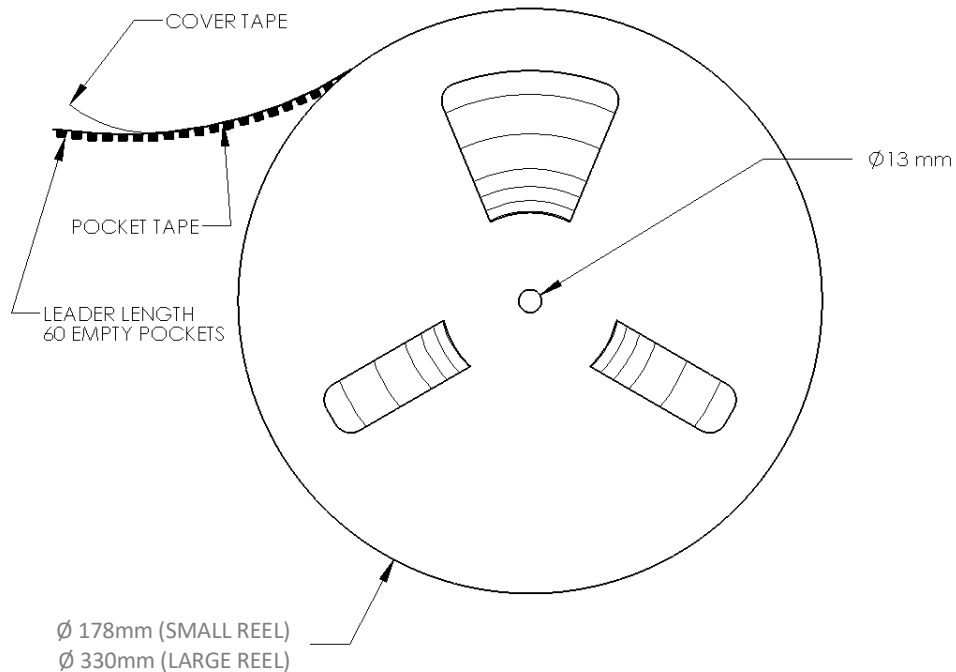

Figure 13: Emitter reel specifications (mm).

Notes:

1. Small reel quantity: up to 500 emitters
2. Large reel quantity: 501-2500 emitters.
3. Single flux bin and single wavelength bin per reel.

LZ1 MCPCB Family

Part number	Type of MCPCB	Diameter (mm)	Emitter + MCPCB Thermal Resistance (°C/W)	Typical V _F (V)	Typical I _F (mA)
LZ1-1xxxxxx	1-channel Star	19.9	6.0 + 1.5 = 7.5	3.2	1000

Mechanical Mounting of MCPCB

- MCPCB bending should be avoided as it will cause mechanical stress on the emitter, which could lead to substrate cracking and subsequently LED dies cracking.
- To avoid MCPCB bending:
 - Special attention needs to be paid to the flatness of the heat sink surface and the torque on the screws.
 - Care must be taken when securing the board to the heat sink. This can be done by tightening three M3 screws (or #4-40) in steps and not all the way through at once. Using fewer than three screws will increase the likelihood of board bending.
 - It is recommended to always use plastics washers in combinations with the three screws.
 - If non-taped holes are used with self-tapping screws, it is advised to back out the screws slightly after tightening (with controlled torque) and then re-tighten the screws again.

Thermal interface material

- To properly transfer heat from LED emitter to heat sink, a thermally conductive material is required when mounting the MCPCB on to the heat sink.
- There are several varieties of such material: thermal paste, thermal pads, phase change materials and thermal epoxies. An example of such material is Electrolube EHTC.
- It is critical to verify the material's thermal resistance to be sufficient for the selected emitter and its operating conditions.

Wire soldering

- To ease soldering wire to MCPCB process, it is advised to preheat the MCPCB on a hot plate of 125-150°C. Subsequently, apply the solder and additional heat from the solder iron will initiate a good solder reflow. It is recommended to use a solder iron of more than 60W.
- It is advised to use lead-free, no-clean solder. For example: SN-96.5 AG-3.0 CU 0.5 #58/275 from Kester (pn: 24-7068-7601)

LZ1-1xxxxx

1 channel, Standard Star MCPCB (1x1) Dimensions (mm)

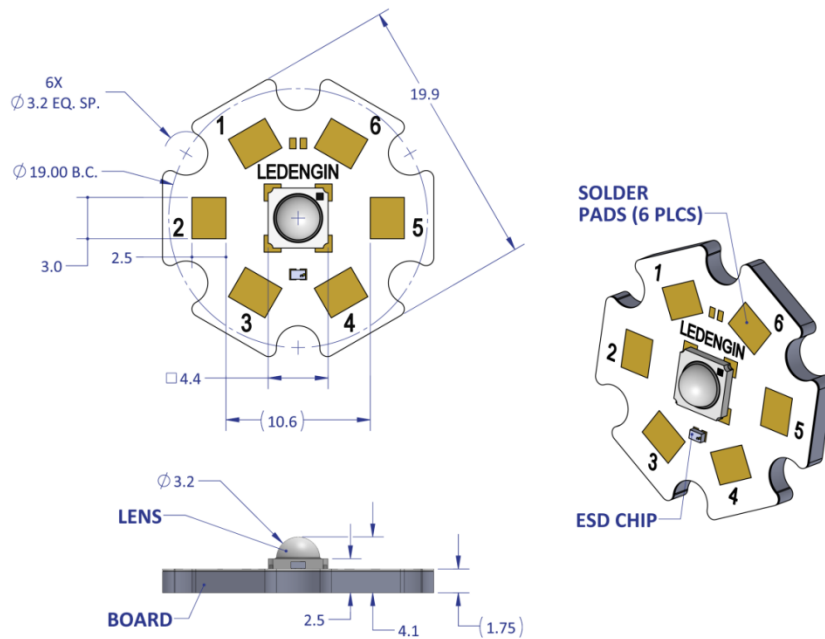

Notes:

- Unless otherwise noted, the tolerance = ± 0.2 mm.
- Slots in MCPCB are for M3 or #4-40 mounting screws.
- LED Engin recommends plastic washers to electrically insulate screws from solder pads and electrical traces.
- LED Engin recommends using thermal interface material when attaching the MCPCB to a heat sink.
- The thermal resistance of the MCPCB is: $R_{\theta_{C-B}} 1.5^{\circ}\text{C/W}$

Components used

MCPCB:	HT04503	(Bergquist)
ESD/TVS Diode:	BZT52C5V1LP-7	(Diodes, Inc., for 1 LED die)
	VBUS05L1-DD1	(Vishay Semiconductors, for 1 LED die)

Pad layout			
Ch.	MCPCB Pad	String/die	Function
1	1,2,3	1/A	Cathode -
	4,5,6		Anode +

About LED Engin

LED Engin, an OSRAM business based in California's Silicon Valley, develops, manufactures, and sells advanced LED emitters, optics and light engines to create uncompromised lighting experiences for a wide range of entertainment, architectural, general lighting and specialty applications. LuxiGen™ multi-die emitter and secondary lens combinations reliably deliver industry-leading flux density, upwards of 5000 quality lumens to a target, in a wide spectrum of colors including whites, tunable whites, multi-color and UV LEDs in a unique patented compact ceramic package. Our LuxiTune™ series of tunable white lighting modules leverage our LuxiGen emitters and lenses to deliver quality, control, freedom and high density tunable white light solutions for a broad range of new recessed and downlighting applications. The small size, yet remarkably powerful beam output and superior in-source color mixing, allows for a previously unobtainable freedom of design wherever high-flux density, directional light is required. LED Engin is committed to providing products that conserve natural resources and reduce greenhouse emissions; and reserves the right to make changes to improve performance without notice.

For more information, please contact LEDE-Sales@osram.com or +1 408 922-7200.