

1

2

3

4

5

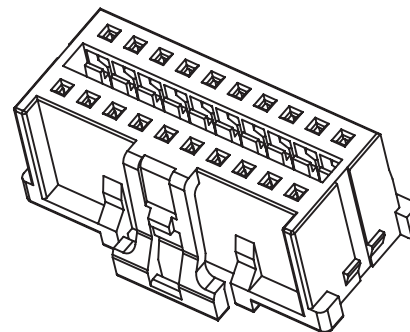
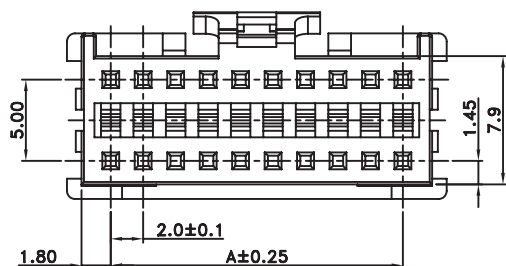

TECHNICAL CHARACTERISTICS

MATERIAL
 INSULATOR: NY 66
 FLAMMABILITY RATING: UL94-V0
 COLOR: WHITE
 PITCH: 2.00 MM

ENVIRONMENTAL
 OPERATING TEMPERATURE: -25 UP TO 85°C
 COMPLIANCE: LEAD FREE AND ROHS

ELECTRICAL
 INSULATOR RESISTANCE: >1000 MOHM
 DIELECTRIC WITHSTANDING VOLTAGE: 1000 VAC/MN

STANDARD
 IEC 60309-2 CERTIFIED: E323964

PACKAGING
 BAG

Poles	Dimension(mm)				
	A	B	C	D	E
4x2	6.0	11.4	9.6	4.7	8.4
5x2	8.0	13.4	11.6	4.7	8.4
6x2	10.0	15.4	13.6	7.8	11.6
7x2	12.0	17.4	15.6	7.8	11.6
8x2	14.0	19.4	17.6	7.8	11.6
9x2	16.0	21.4	19.6	7.8	11.6
10x2	18.0	23.4	21.6	7.8	11.6
11x2	20.0	25.4	23.6	7.8	11.6
12x2	22.0	27.4	25.6	7.8	11.6
13x2	24.0	29.4	27.6	7.8	11.6
14x2	26.0	31.4	29.6	7.8	11.6
15x2	28.0	33.4	31.6	7.8	11.6
16x2	30.0	35.4	33.6	7.8	11.6
17x2	32.0	37.4	35.6	7.8	11.6
18x2	34.0	39.4	37.6	7.8	11.6
19x2	36.0	41.4	39.6	7.8	11.6
20x2	38.0	43.4	41.6	7.8	11.6

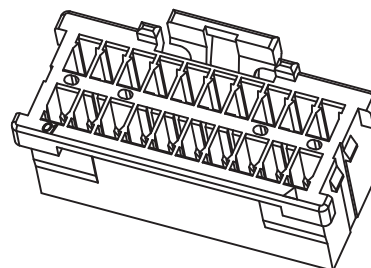
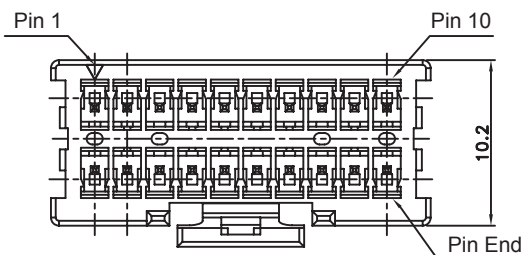
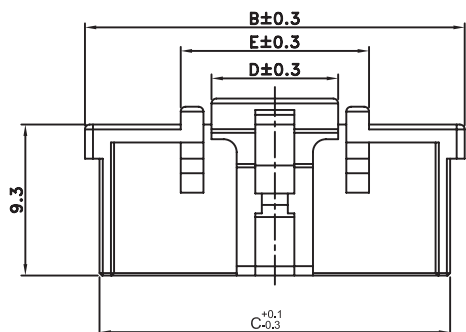
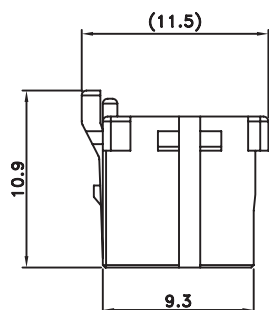

G			
F			
E			
D	01-SEP-16	CERTIFIED	AK
C	25-JAN-16	TPK UPDATE	AK
B	06-AUG-13	CHARACTERISTIC	QL
A	15-MAY-12	PDF	GG
REV	DATE	FILE	BY

PROJECTION:

APPROVAL: BBu

GENERAL TOLERANCE
 .X = +/- 0.2
 .XX = +/- 0.15

UNIT: MM
 SCALE:
 SHEET: 1/3
 DRAW: MIKE

DESCRIPTION: 2.00 MM DUAL ROW FEMALE TERMINAL HOUSING

WERI PART NO: 624 0xx 213 322

SIZE
A4

1

2

3

4

5

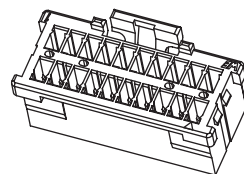

BAG PACKING

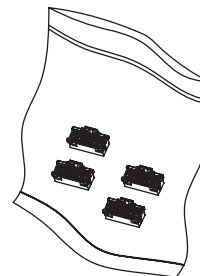

CARTON PACKING

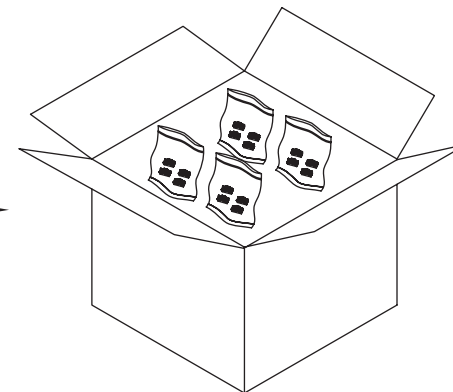

Poles	BAG PACKING		Carton PACKING	
	SPCE	Quantity (pcs)	Quantity (bag)	Quantity (pcs)
4x2	309*256*0.08	1000	20	20,000
5x2	309*256*0.08	1000	20	20,000
6x2	309*256*0.08	1000	18	18,000
7x2	309*256*0.08	1000	16	16,000
8x2	309*256*0.08	1000	14	14,000
9x2	309*256*0.08	1000	12	12,000
10x2	309*256*0.08	500	22	11,000
11x2	309*256*0.08	500	22	11,000
12x2	309*256*0.08	500	22	11,000
13x2	309*256*0.08	500	20	10,000
14x2	309*256*0.08	500	20	10,000
15x2	309*256*0.08	500	18	9,000
16x2	309*256*0.08	250	32	8,000
17x2	309*256*0.08	250	28	7,000
18x2	309*256*0.08	250	24	6,000
19x2	309*256*0.08	250	20	5,000
20x2	309*256*0.08	250	16	4,000

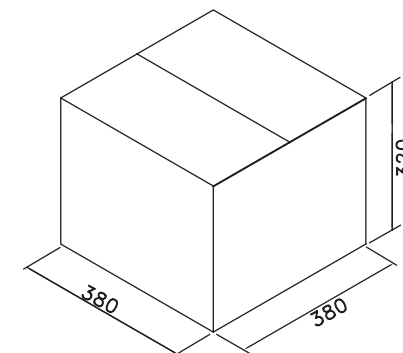

G				PROJECTION:	GENERAL TOLERANCE		DESCRIPTION: WTB 2.00MM DUAL ROWS TERMINAL HOUSING WERI PART NO: 624 0xx 213 322	SIZE A4
F					.X = +/- 0.2			
E					.XX = +/- 0.15			
D					APPROVAL: BBu			
C					SCALE:			
B					SHEET: 2/3			
A					DRAW: MIKE			
REV	DATE	FILE	BY					

1

2

3

4

5

Cautions and Warnings:

This electronic component is designed and developed with the intention for use in general electronics equipments.

Before incorporating the components into any equipments in the field such as aerospace, aviation, nuclear control, submarine, transportation, (automotive control, train control, ship control), transportation signal, disaster prevention, medical, public information network etc. where higher safety and reliability are especially required or if there is possibility of direct damage or injury to human body, Würth Elektronik must be asked for a written approval.

In addition, even electronic component in general electronic equipments, when used in electrical circuits that require high safety, reliability functions or performance, the sufficient reliability evaluation-check for the safety must be performed before by the user before usage.

A

B

C

RoHS Compliant

G				PROJECTION: 	GENERAL TOLERANCE .X = +/- 0.2 .XX = +/- 0.15		
F							
E							
D							
C				APPROVAL: JC	UNIT: MM	DESCRIPTION: DISCLAIMER	SIZE A4
B					SCALE:		
A	10-SEP-14	PDF	QL		SHEET: 3/3	WERI PART NO: DISCLAIMER	
REV	DATE	FILE	BY		DRAW: QL		

D

Mouser Electronics

Authorized Distributor

Click to View Pricing, Inventory, Delivery & Lifecycle Information:

[Würth Electronics:](#)

[624014213322](#) [624028213322](#) [624008213322](#) [624022213322](#) [624020213322](#) [624034213322](#) [624040213322](#)
[624018213322](#) [624012213322](#) [624036213322](#) [624010213322](#) [624024213322](#) [624032213322](#) [624030213322](#)
[624026213322](#) [624038213322](#) [624016213322](#)