

MBC250 Series Medical Power Supplies 12 VDC, 24 VDC, 48 VDC



The MBC250 series of AC-DC power supplies are designed to suit medical and many other applications. This family meets the international information technology and medical safety standards. The high efficiency design has minimal power loss in end equipment, resulting in higher reliability, ease of thermal management.

Features

- Designed for Medical equipment (meet MOOP and MOPP)
- High efficiency up to 90% at 230 VAC full load
- Universal AC input voltage range: 90-264 VAC
- Active power factor correction
- Over temperature, output over voltage, over current and short circuit protection
- Input over voltage, under voltage protection
- Low conducted and radiated EMI (EN 55011 class A 6db margin)
- Safety approval to UL 60601-1 3rd, CSA60601-1 3rd and IEC60950-1 3rd
- High power density design: 11.2 W/in³
- Compact size: 3.0 (W) x 1.5 (H) x 5.0 (L) inch
- ROHS compliant

Applications

- Medical
- Telecom
- Datacom
- Industrial equipment

North America
+1-866.513.2839

Asia-Pacific
+86.755.29885888

Europe, Middle East
+353 61 225 977

Bel Power Solutions
152 North 3rd Street, Suite 805
San Jose, CA 95112 USA

tech.support@psbel.com
belpowersolutions.com

© 2015 Bel Power Solutions, inc.

BCD.G0901_AB

MBC250-10XXG

1 Ordering Information

MODELS	OUTPUT VOLTAGE (VDC)	MAX LOAD CONVECTION	MAX LOAD 200 LFM	MINIMUM LOAD	RIPPLE & NOISE	TOTAL REGULATION
MBC250-1012G	12 V	10 A	19 A	0 A	1%	± 3%
MBC250-1024G	24 V	5 A	10.5 A	0 A	1%	± 3%
MBC250-1048G	48 V	2 A	5.25 A	0 A	1%	± 3%
MBC250-1024S302G ¹⁾	26.7 V	4.5 A	9.43 A	0 A	1%	± 3%

¹⁾MBC250-1024S302G is an extended model for MBC250-1024G.

2 Overview

The MBC250-10XXG is a high efficiency and high power density AC to DC power supply. It uses single phase transition mode PFC converter and well proven two-FET forward converter with output diode rectifiers, providing increased system reliability and high efficiency. With around 200 LFM (1 m/s) system air cooling, MBC250-1012G can delivery up to 228W continuous output power and 252W for MBC250-1024G and MBC250-1048G.

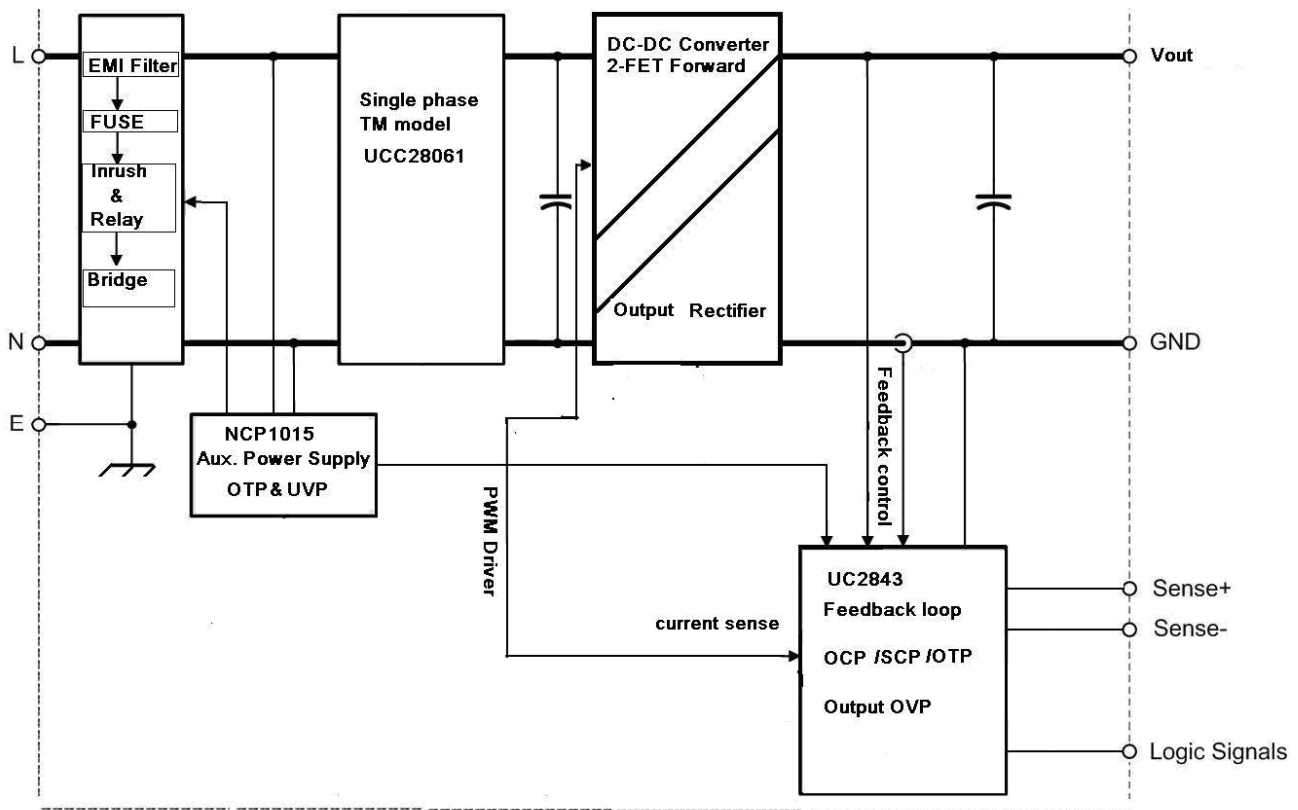

Figure 1: MBC250-10XXG block diagram

MBC250-10XXG

3 Absolute Maximum Ratings

Stresses in excess of the absolute maximum ratings may cause performance degradation, adversely affect long-term reliability, and cause permanent damage to the supply.

PARAMETER	DESCRIPTION / CONDITION	MIN	NOM	MAX	UNIT
$V_{i,max}$	Max continuous input			264	VAC

4 Environmental and Mechanical

PARAMETER	DESCRIPTION / CONDITION	MIN	NOM	MAX	UNIT
T_A	Ambient temperature	$V_{i,min}$ to $V_{i,max}$, $I_{i,nom}$		+50	°C
$T_{A,ext}$	Extended temp range	Derated output		+70	°C
T_S	Storage temperature	Non-operational		+85	°C
	Dimensions	Width		76.2	mm
		Height		38.1	mm
		Depth		127.0	mm
M	Weight		0.5		kg

5 Input Specifications

General Condition: $T_A = -10... 50$ °C unless otherwise noted.

Active fan air cooling required: 200 LFM (1 m/s).

PARAMETER	DESCRIPTION / CONDITION	MIN	NOM	MAX	UNIT
$V_{i,nom}$	Nominal input voltage	100		240	VAC
V_i	Input voltage ranges	Normal operating ($V_{i,min}$ to $V_{i,max}$)		264	VAC
$I_{i,max}$	Max input current			3.5	A_{rms}
I_p	Inrush current limitation	$V_{i,nom}=115$ VAC, $T=25$ °C (see Figure 2) $V_{i,nom}=230$ VAC, $T=25$ °C (see Figure 3)		30 60	A_p
F_i	Input frequency	47	50/60	63	Hz
PF	Power factor	$V_{i,nom}=264$ VAC, $> 0.5 I_{o,nom}$			W/VA
$V_{i,on}$	Turn-on input voltage ¹⁾	Ramping up		89	VAC
$V_{i,off}$	Turn-off input voltage ¹⁾	Ramping down		85	VAC
η	Efficiency	$V_{i,nom}=230$ VAC, $0.5 \cdot I_{o,nom}$, V_o,nom , $T_A = 25$ °C		88 ²⁾	%
		$V_{i,nom}=230$ VAC, $1.0 \cdot I_{o,nom}$, V_o,nom , $T_A = 25$ °C		90	%
T_{hold}	Hold-up Time	After last AC zero point, V_o within regulation, $V_i = 115$ VAC, $P_{o,nom}$	12	18	mS
L_i	Earth leakage current	264 VAC at 60 Hz		300	μA

¹⁾ The power supply is provided with a minimum hysteresis of 2 V during turn-on and turn-off within the ranges.

²⁾ For MBC250-1012G/1048G half load minimum efficiency is 87.5%.

5.1 Input Fuse

Double fusing with 5 A slow-blow type (5 × 20 mm), in series with Live and neutral line inside of the power supply protects against severe defects. The fuses and a VDR form together with the input filter an effective protection against high input transients.

MBC250-10XXG

5.2 Inrush Current

The AC-DC power supply exhibits an X-capacitance of only 2.0 μF , resulting in a low and short peak current, when the supply is connected to the mains. The internal bulk capacitor will be charged through a power resistor which will limit the inrush current (see Figure 2 and 3).

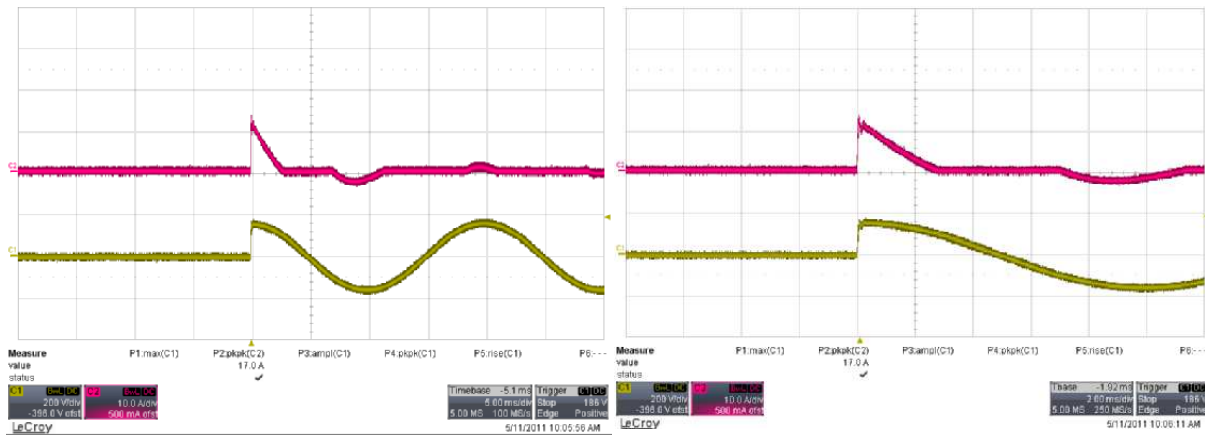

Figure 2: Inrush current, $V_{in} = 115 \text{ VAC}$, $\text{Phase}=90^\circ$, CH1: V_{in} (200 V/div), CH2: I_{in} (10 A/div)
Test data: the inrush current is 13 A at 115 VAC input

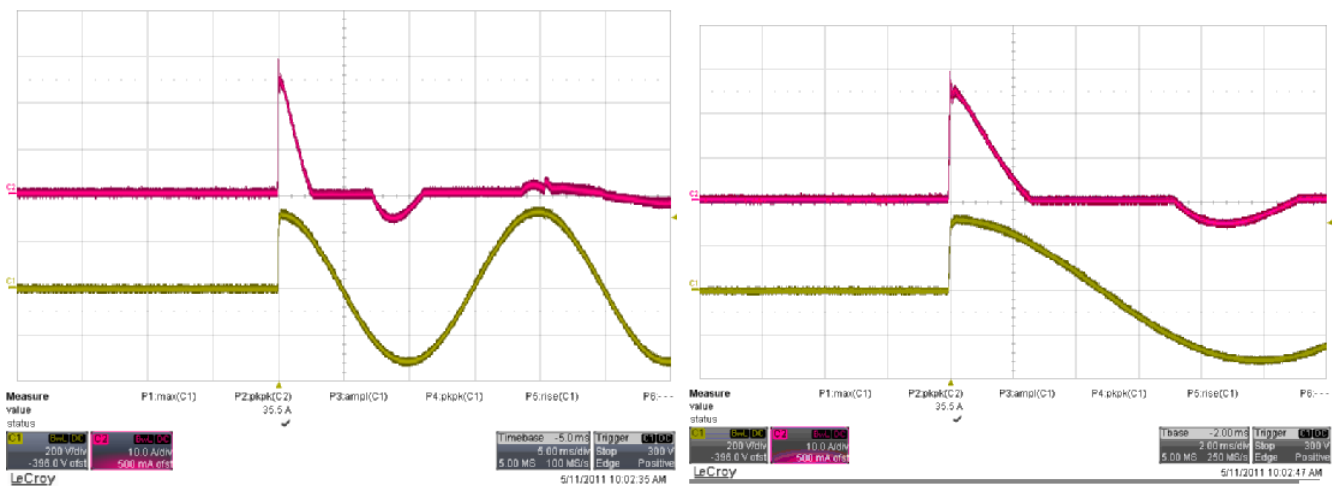

Figure 3: Inrush current, $V_{in} = 230 \text{ VAC}$, $\text{Phase}=90^\circ$, CH1: V_{in} (200 V/div), CH2: I_{in} (10 A/div)
Test data: the inrush current is 30 A at 230 VAC input

5.3 Input Under-voltage

If the sinusoidal input voltage stays below the input under voltage lockout threshold V_{on} , the supply will be inhibited. Once the input voltage returns within the normal operating range, the supply will return to normal operation again.

5.4 Power Factor Correction

Power factor correction (PFC) is achieved by controlling the input current waveform synchronously with the input voltage. A specified PFC controller is implemented in single phase transition mode topology giving outstanding PFC results over a wide input voltage and load ranges. The input current will follow the shape of the input voltage.

MBC250-10XXG

5.5 Efficiency

The high efficiency (see Figure 4, 5 and 6) is achieved by using state-of-the-art silicon power devices in conjunction with transition mode PFC topology minimizing switching losses. Synchronous rectifiers on the output reduce the losses in the high current output path for MBC250-1012G.

Schottky diode and ultra-fast diode are used as rectifiers for MBC250-1024G and MBC250-1048G separately due to the high output voltage level.

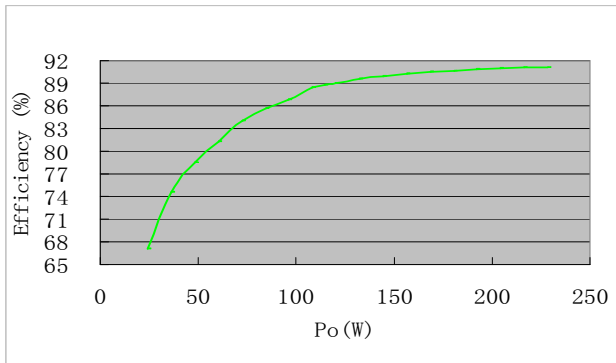

Figure 4: Efficiency vs. Output Power at 230 VAC, MBC250-1012G

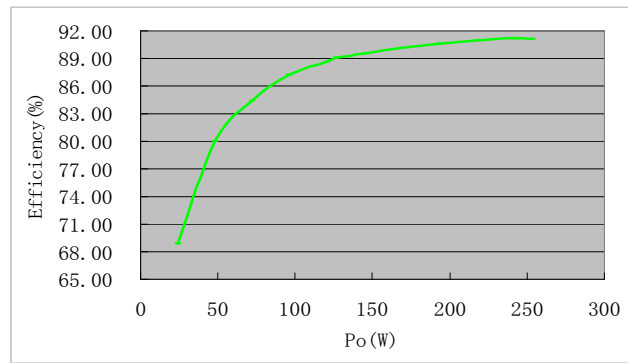

Figure 5: Efficiency vs. Output Power at 230 VAC, MBC250-1024G

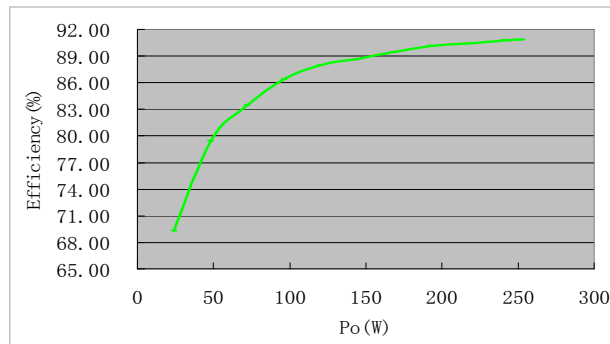

Figure 6: Efficiency vs. Output Power at 230 VAC, MBC250-1048G

MBC250-10XXG

6 Output Specifications

General Condition: $T_A = -10 \dots +50 \text{ }^\circ\text{C}$ unless otherwise noted. Active fan air cooling required: 200 LFM (1 m/s).

PARAMETER	DESCRIPTION / CONDITION	MIN	NOM	MAX	UNIT		
Main Output V_o							
V_o	Nominal output voltage	$0.5 \cdot I_o, T_{amb} = 25 \text{ }^\circ\text{C}$	MBC250-1012G	12.0		VDC	
			MBC250-1024G	24.0 ¹⁾		VDC	
			MBC250-1048G	48.0		VDC	
$V_{o \text{ set}}$	Output set point accuracy	$0.5 \cdot I_o, T_{amb} = 25 \text{ }^\circ\text{C}$	MBC250-1012G	-50	50	mV	
			MBC250-1024G	-75	75	mV	
			MBC250-1048G	-150	150	mV	
$P_{o \text{ nom}}$	Nominal output power		MBC250-1012G	0	228	W	
			MBC250-1024G	0	252	W	
			MBC250-1048G	0	252	W	
$I_{o \text{ nom}}$	Nominal output current		MBC250-1012G	0	19	A	
			MBC250-1024G	0	10.5 ²⁾	A	
			MBC250-1048G	0	5.25	A	
$V_{o \text{ p-p}}$	Output ripple voltage	$V_{o \text{ nom}}, I_{o \text{ nom}}, 20 \text{ MHz BW}$	MBC250-1012G	60	120	mVpp	
			MBC250-1024G	80	240 ³⁾	mVpp	
			MBC250-1048G	150	480	mVpp	
$dV_{o \text{ Load}}$	Load regulation	$V_i = V_{i \text{ nom}}, 0 - 100 \% I_{o \text{ nom}}$	MBC250-1012G	-360	50	360	mV
			MBC250-1024G	-720 ⁴⁾	80	720 ⁴⁾	mV
			MBC250-1048G	-1440	130	1440	mV
$dV_{o \text{ Line}}$	Line regulation	$V_i = V_{i \text{ min}} \dots V_{i \text{ max}}$	MBC250-1012G	-120	80	120	mV
			MBC250-1024G	-120	80	120	mV
			MBC250-1048G	-120	80	120	mV
dV_{dyn}	Dynamic load regulation	$\Delta I_o = 50\% I_{o \text{ nom}}, I_o = 50 \dots 100\% I_{o \text{ nom}}, dI_o/dt = 1 \text{ A}/\mu\text{s}, \text{ recovery within } 5\% \text{ of } V_{o \text{ nom}}$	MBC250-1012G	-0.6	0.25	0.6	V
			MBC250-1024G	-1.2	0.45	1.2	V
			MBC250-1048G	-2.4	0.7	2.4	V
t_{rec}	Recovery time			2	mS		
t_{delay}	Turn-on Delay	Time required for output within regulation after initial application of AC input @90 VAC	0.3	1	2	Sec	
t_{rise}	Turn on Rise time	$V_o = 10 \dots 90\% V_{o \text{ nom}}$		10	20	mS	
C_{Load}	Capacitive loading	$T_{amb} = 25 \text{ }^\circ\text{C}$	MBC250-1012G		4200	μF	
			MBC250-1024G		2300	μF	
			MBC250-1048G		1150	μF	

¹⁾ The nominal output voltage is 26.7 VDC for MBC250-1024S302G.

²⁾ The rated output current is 9.43 A for MBC250-1024S302G.

³⁾ The output ripple voltage is 267 mVpp for MBC250-1024S302G.

⁴⁾ The load regulation is $\pm 800 \text{ mV}$ for MBC250-1024S302G.

MBC250-10XXG

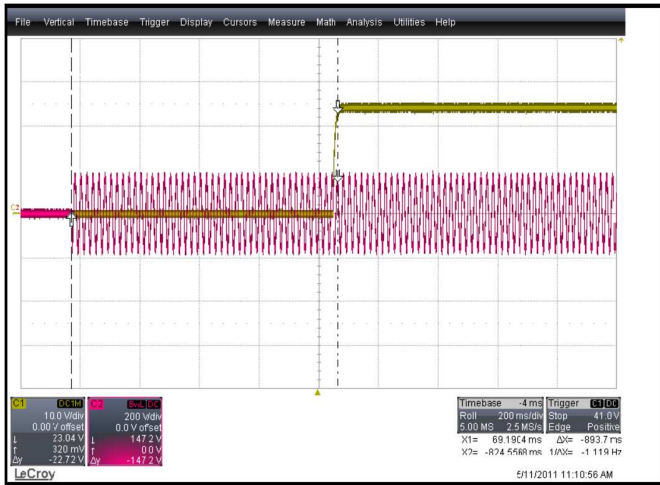

CH1:Vo (10 V/div) CH2:Vin (200 V/div)
 Figure 5: Turn on AC line 115 VAC, full load (200 mS/div)

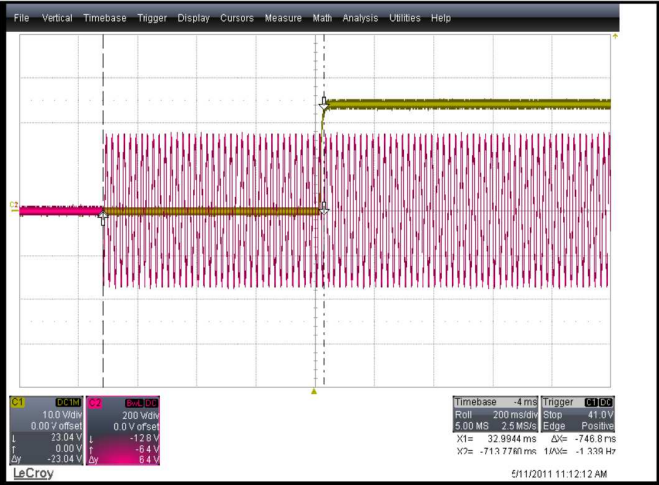

CH1:Vo (10 V/div) CH2:Vin (200 V/div)
 Figure 6: Turn on AC line 230 VAC, full load (200 mS/div)

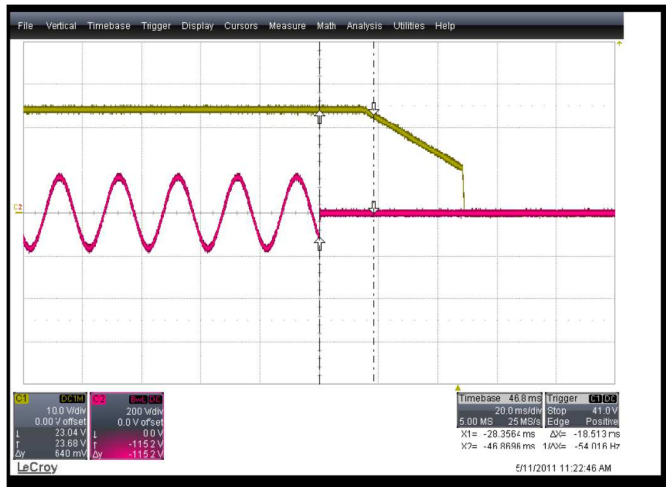

CH1:Vo (10 V/div) CH2:Vin (200 V/div)
 Figure 7: Turn off AC line at 115 VAC, full load (20 mS/div)

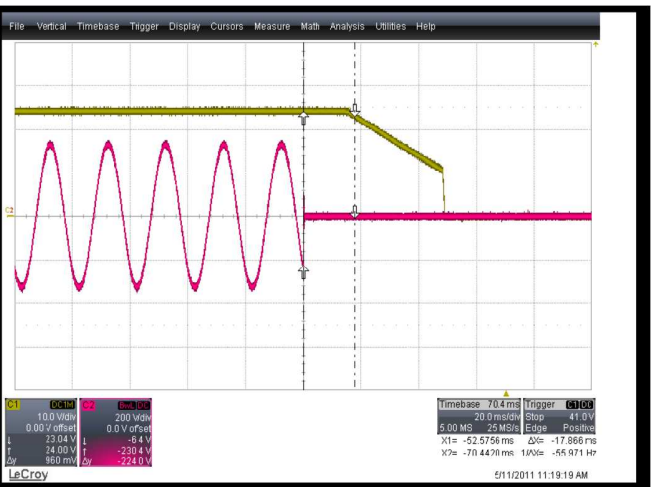

CH1:Vo (10 V/div) CH2:Vin (200 V/div)
 Figure 8: Turn off AC line at 230 VAC, full load (20 mS/div)

MBC250-10XXG

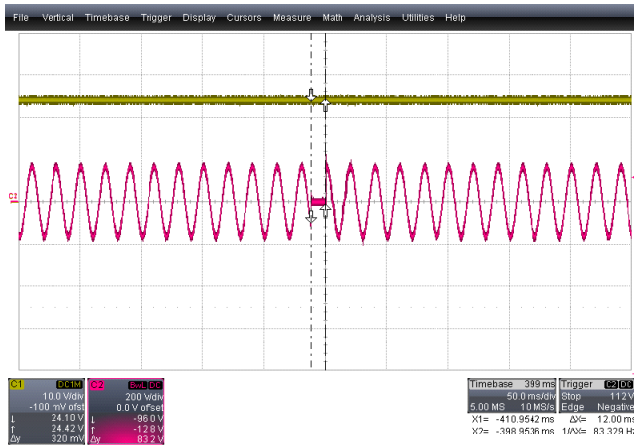

CH1:Vo (10 V/div) CH2:Vin (200 V/div)
Figure 9: AC drop out 12 mS at 115 VAC (50 mS/div)



CH1:Vo (10 V/div) CH2:Vin (200 V/div)
Figure 10: AC drop out 12 mS at 230 VAC (50 mS/div)



CH1:Vo (10 V/div) CH2:Vin (200 V/div)
Figure 11: AC drop out 50 mS@115 VAC (50 mS/div), Vo restart

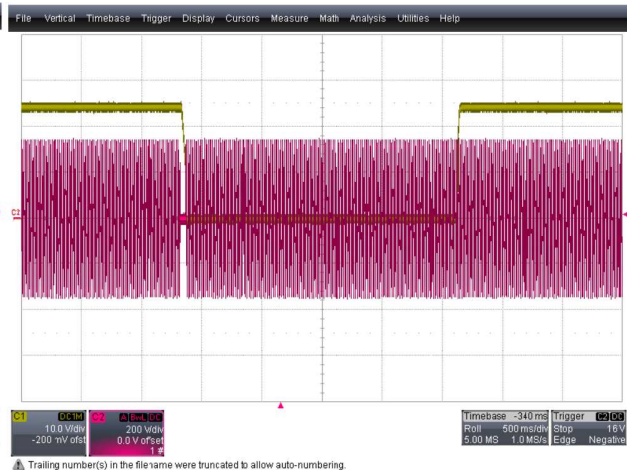

CH1:Vo (10 V/div) CH2:Vin (200 V/div)
Figure 12: AC drop out 50 mS@230 VAC (50 mS/div), Vo restart

MBC250-10XXG

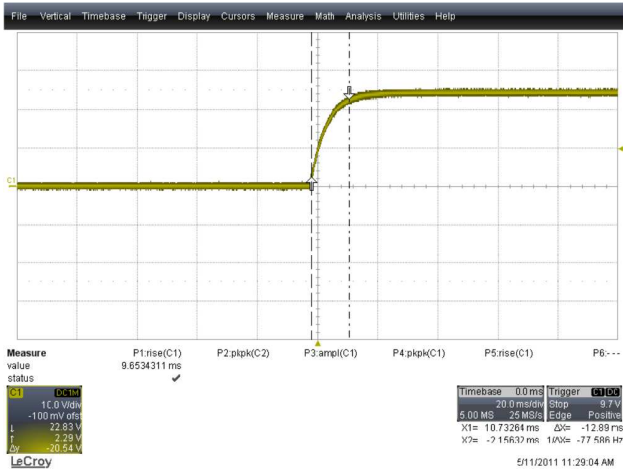

CH1:Vo (10 V/div)
Figure 13: Vo rise time at 115 VAC (20 ms/div)

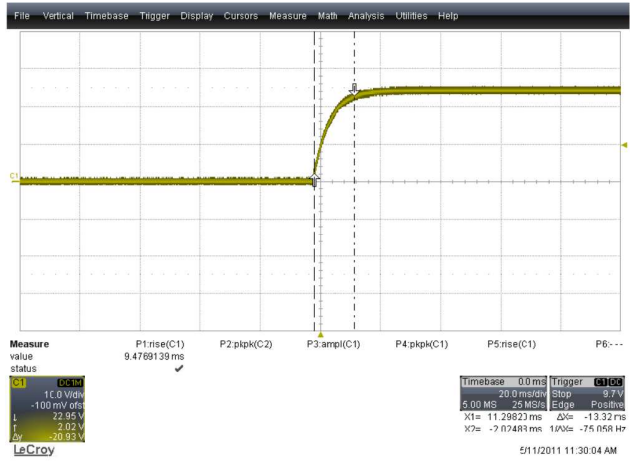

CH1:Vo (10 V/div)
Figure 14: Vo rise time at 230 VAC (20 ms/div)

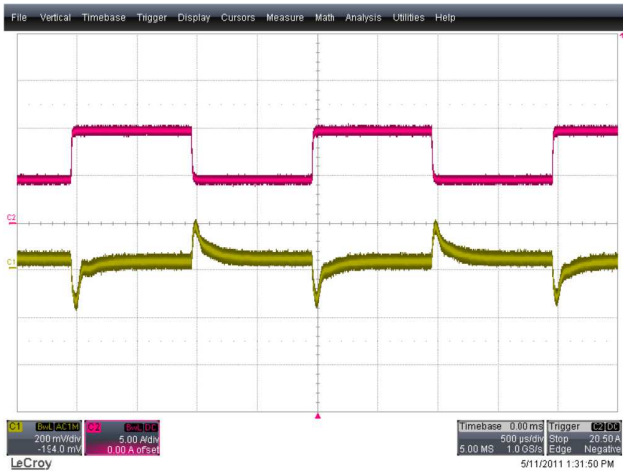

CH1: Vo (200 mV/div) CH2: I1 (5 A/div)

Figure 15: Load transient VO, 5.25 A <-> 10.5 A (0.5 ms/div), 2 A μ s

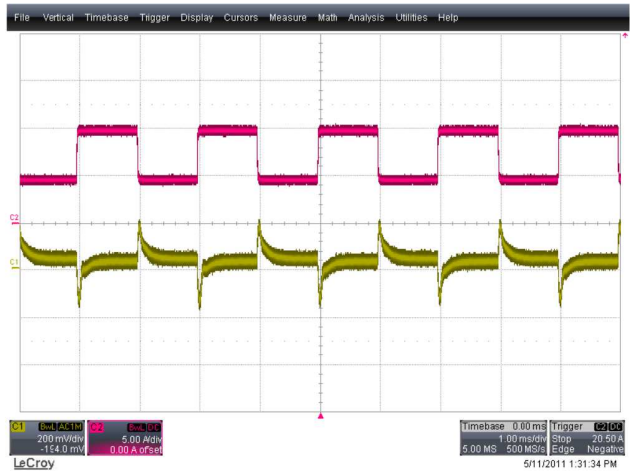

CH1: Vo (200 mV/div) CH2: I1 (5 A/div)

Figure 16: Load transient VO, 5.25 A <-> 10.5 A (1 ms/div), 2 A μ s

MBC250-10XXG

7 Protection

PARAMETER	DESCRIPTION / CONDITION	MIN	NOM	MAX	UNIT	
F	Input fuses (L and N)	Not user accessible, time lag characteristic		5.0	A	
$V_{O\ ov}$	OV threshold	MBC250-1012G	14.0	16.0	VDC	
		MBC250-1024G	28.0 ¹⁾	32.0 ¹⁾	VDC	
		MBC250-1048G	53	57	VDC	
$I_{o\ lim}$	Current limit	$V_i > 90\ VAC, T_a < 50\ ^\circ C$				
		MBC250-1012G	21	22.5	25	A
		MBC250-1024G	11.5 ²⁾	12.6	13.7 ²⁾	A
	MBC250-1048G	5.8	6.4	6.8	A	
T_{SD}	Over temperature on heat sinks	Automatic shut-down	91	96	101	$^\circ C$

¹⁾ The voltage range of Over Voltage Protection for MBC250-1024S302G is 29.0–34.0 VDC.

²⁾ The current range of Over Current Protection for MBC250-1024S302G is 10.3–12.3 A.

7.1 Overvoltage Protection

The AC-DC power supply provides a fixed threshold overvoltage (OV) protection implemented with a HW comparator. Once an OV condition has been triggered, the supply will shut down and latch the fault condition. The latch can be unlocked by disconnecting the supply from the AC mains only.

7.2 Current Limitation

The main output current limitation will decrease linearly to 50% from 50 $^\circ C$ to 70 $^\circ C$ (ambient temperature at inlet, Fig. 17).

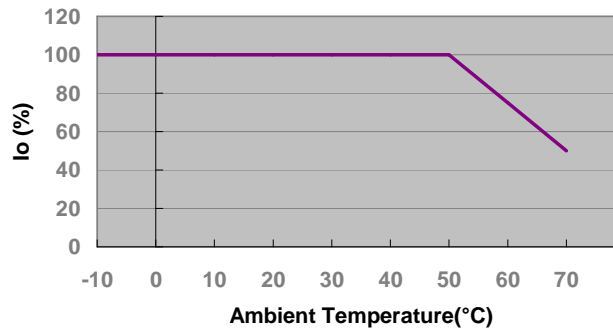

Figure 17: Output Current Limitation Curve

MBC250-10XXG

8 Power Good Signal

The Out-OK output gives a status indication of the converter and the output voltages. It can be used for control functions such as data protection, central system monitoring or as a part of a self-testing system. Connect the Out-OK (Power Good) as shown in Figure 18, $V_{OK} < 1.0\text{ V}$ indicates that the output voltage(s) of the converter are within the range.

The Out-OK is an active low signal, i.e. Power Good will pull low internally when output is within regulation. Out-OK is high impedance internally when there is error condition such as output voltage out of range due to overload or an external overvoltage. This signal is electrically isolated from the output.

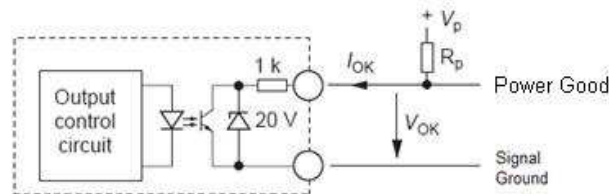

Figure 18: Power Good signal

Power Good Signal Description:

1. O/P V OK – Signal Low, Opto conducting, (max sink current 0.5mA)
2. O/P V Bad – Signal High, Opto opening, (max leakage current 25 μ A)

9 Electromagnetic Compatibility

9.1 Immunity

Note: Most of the immunity requirements are derived from EN 61000-6-1:2007.

TEST	STANDARD / DESCRIPTION	CRITERIA
ESD Contact Discharge	EN 61000-4-2, Level 2	A
RF Susceptibility	EN 61000-4-3, Level 3	A
Fast Transient/Burst	EN 61000-4-4, Level 3	B
Surge	EN 61000-4-5, Class 3	B
RF Conducted Immunity	EN 61000-4-6, Class 3	A
Magnetic Fields	EN 61000-4-8	A
Voltage Dips and Interruptions	EN 61000-4-11	C

9.2 Emission

TEST	STANDARD / DESCRIPTION	CRITERIA
Conducted Emission	EN55011: 0.15 ... 30 MHz, QP and AVG, single unit	Class A 6 dB Margin
Radiated Emission	EN55011 : 30 MHz ... 1 GHz, QP, single unit	Class A 6 dB Margin
Harmonic Emissions	IEC61000-3-2, $V_{in} = 100\text{ VAC}/60\text{ Hz}, 100\% \text{ Load}$	Class A
	IEC61000-3-2, $V_{in} = 240\text{ VAC}/50\text{ Hz}, 100\% \text{ Load}$	Class A
Voltage Fluctuation and Flicker	EN61000-3-3	PASS
Rules for Unintentional Radiations	FCC Part 15, Sub Part-B	PASS

MBC250-10XXG

10 Safety/Approvals

Maximum electric strength testing is performed in the factory according to IEC 60950-1, Input-to-output electric strength tests should not be repeated in the field. Power-One will not honor any warranty claims resulting from electric strength field tests.

PARAMETER	DESCRIPTION / CONDITION	MIN	NOM	MAX	UNIT
Agency Approvals	UL60601-1 3 rd CSA60601-1 3 rd IEC 60950-1 3 rd			Approved by independent body (see CE Declaration)	
Insulation Safety Rating	Input / Case		Basic		
	Input / Output		Reinforced		
	Output / Case		Basic		
α Creepage / clearance	Primary (L/N) to protective earth (PE)		According to safety standard		mm
	Primary to secondary				mm
Electrical strength test	Input to case		2.3		KVDC
	Input to output		4.0		KVAC
	Output and Signals to case		1.5		KVAC

11 Mechanical

11.1 Dimensions

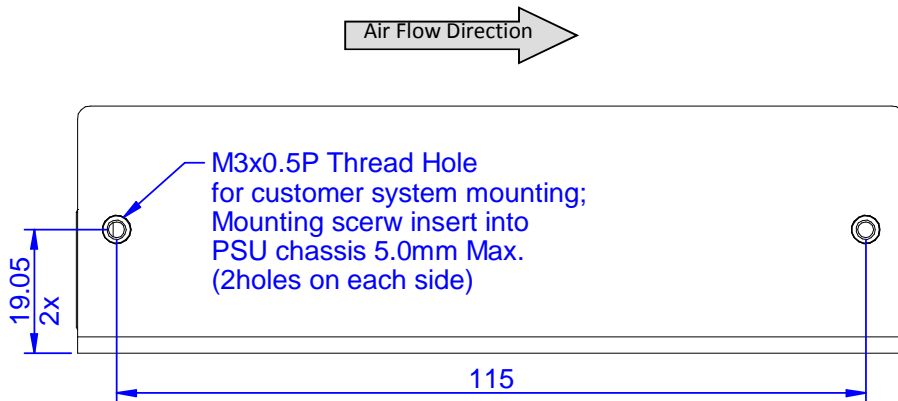

Figure 19: Side view 1

MBC250-10XXG

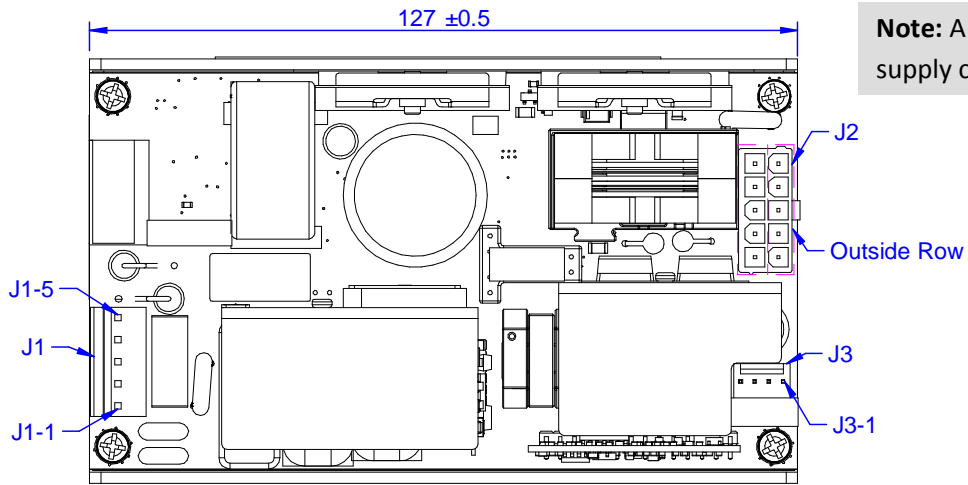

Figure 20: Top view

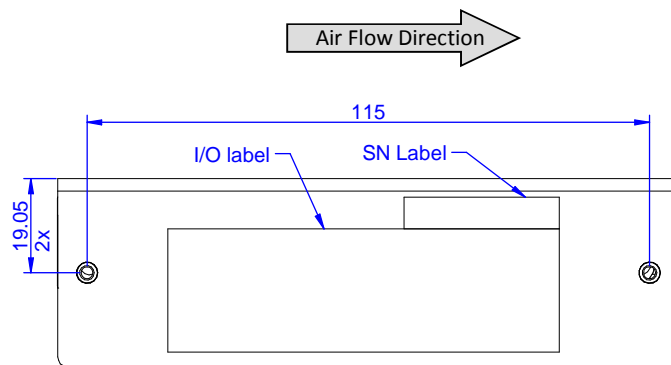

Figure 21: Side view 2

MBC250-10XXG

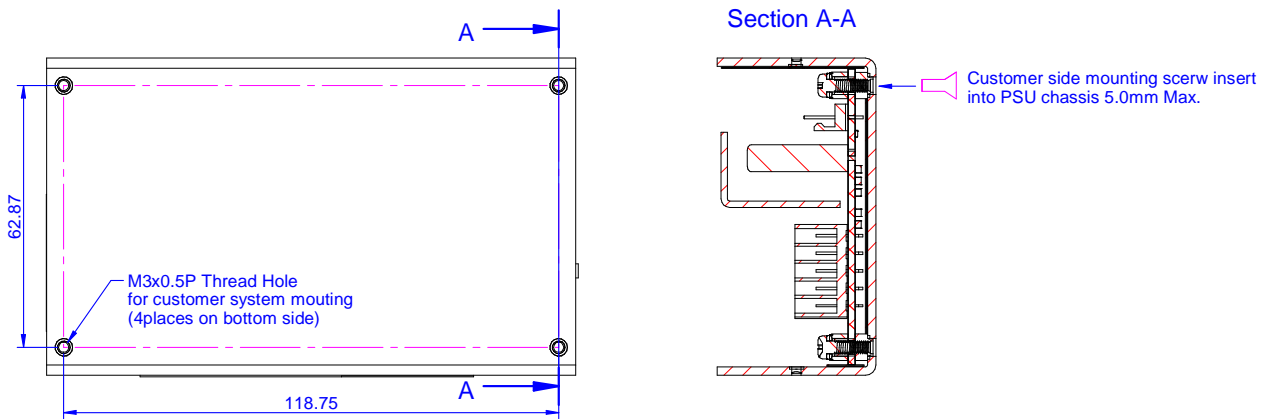

Figure 22: Bottom view 2

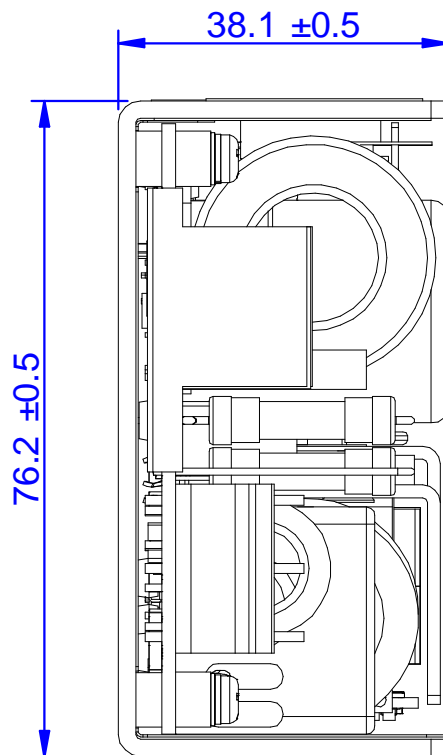

Figure 23: Front view

MBC250-10XXG

11.2 Connections

Connector Pin Assignment:

PIN	CONNECTION
1	Earth
2	Not fitted
3	Neutral
4	Note fitted
5	Line

PIN	CONNECTION
Inside Row (Pin 1-5)	-Vo
Outside Row (Pin 6- 10)	+Vo

PIN	CONNECTION
1	Vo Sense -
2	Vo Sense +
3	Power Good
4	Power Good Return

Mating parts(Molex or equivalent):

CONNECTOR	HOUSING	CRIMP TERMINAL	WIRE GAUGE
J1	09-50-3051	08-50-0105	AWG# 18
J2	39-01-2105	44476-312	AWG# 16
J3	22-01-3047	08-50-0113	AWG# 22-30

For more information on these products consult: tech.support@psbel.com

NUCLEAR AND MEDICAL APPLICATIONS - Products are not designed or intended for use as critical components in life support systems, equipment used in hazardous environments, or nuclear control systems.

TECHNICAL REVISIONS - The appearance of products, including safety agency certifications pictured on labels, may change depending on the date manufactured. Specifications are subject to change without notice.

Mouser Electronics

Authorized Distributor

Click to View Pricing, Inventory, Delivery & Lifecycle Information:

[Bel Power Solutions:](#)

[MBC250-1012G](#) [MBC250-1024G](#) [MBC250-1048G](#)