

## Low Output, Adjustable, Ultralow-Power, 100-mA Low-Dropout Linear Regulator

Check for Samples: [TPS76201-Q1](#)

### FEATURES

- **Qualified for Automotive Applications**
- **100-mA Low-Dropout Regulator**
- **Adjustable Output Voltage: 0.7 V to 5.5 V**
- **Only 27- $\mu$ A Quiescent Current at 100 mA**
- **1- $\mu$ A Quiescent Current in Standby Mode**
- **Overcurrent Limitation**
- **-40°C to +125°C Operating Ambient Temperature Range**
- **Available in 5-Pin SOT-23 (DBV) Package**

#### DBV PACKAGE (TOP VIEW)

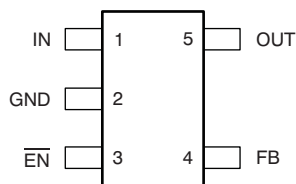

#### GROUND CURRENT vs JUNCTION TEMPERATURE

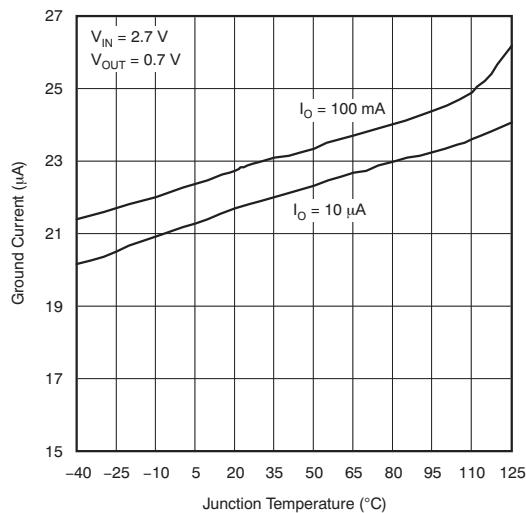

### DESCRIPTION

The TPS76201-Q1 low-dropout (LDO) voltage regulator features an adjustable output voltage as low as 0.7 V. It is an ideal regulator for sub 1.2-V DSP core voltage supplies and is equally suited for similar applications with other low-voltage processors and controllers. SOT-23 packaging and the high-efficiency that results from the ultralow power regulator operation make the TPS76201-Q1 especially useful in handheld and portable battery applications. This regulator features low dropout voltages and ultralow quiescent current compared to conventional LDO regulators. Offered in a five-terminal, small outline integrated circuit (SOT-23) package, the TPS76201-Q1 is ideal for micropower operations and where board space is at a premium.

A combination of new circuit design and process innovation has enabled the usual PNP pass transistor to be replaced by a PMOS pass element. Because the PMOS pass element is a voltage-driven device, the quiescent current is ultralow (30  $\mu$ A maximum) and is stable over the entire range of output load current (10  $\mu$ A to 100 mA). Intended for use in portable systems such as laptops and cellular phones, the ultralow-power operation results in a significant increase in the system battery operating life.

The TPS76201-Q1 also features a logic-enabled sleep mode to shut down the regulator, reducing quiescent current to 1  $\mu$ A typical at  $T_J = +25^\circ\text{C}$ . The TPS76201-Q1 is offered in an adjustable version (programmable over the range of 0.7 V to 5.5 V).



Please be aware that an important notice concerning availability, standard warranty, and use in critical applications of Texas Instruments semiconductor products and disclaimers thereto appears at the end of this data sheet.

All trademarks are the property of their respective owners.



This integrated circuit can be damaged by ESD. Texas Instruments recommends that all integrated circuits be handled with appropriate precautions. Failure to observe proper handling and installation procedures can cause damage.

ESD damage can range from subtle performance degradation to complete device failure. Precision integrated circuits may be more susceptible to damage because very small parametric changes could cause the device not to meet its published specifications.

### ORDERING INFORMATION<sup>(1)</sup>

VOLTAGE <sup>(2)</sup>	T <sub>A</sub>	PACKAGE	PART NUMBER	PACKAGE MARKING	TRANSPORT MEDIA, QUANTITY
Variable 0.7 V to 5.5 V	–40°C to +125°C	SOT-23 (DBV)	TPS76201QDBVRQ1	PUEQ	Tape and reel, 3000

- (1) For the most current package and ordering information see the Package Option Addendum at the end of this document, or visit the device product folder at [www.ti.com](http://www.ti.com).  
 (2) Contact the factory for availability of fixed output options.

### ABSOLUTE MAXIMUM RATINGS<sup>(1)</sup>

Over operating free-air temperature range (unless otherwise noted).

PARAMETER	TPS76201-Q1	UNIT
Input voltage range, V <sub>IN</sub> <sup>(2)</sup>	–0.3 to +13.5	V
Voltage range at $\overline{EN}$	–0.3 to V <sub>IN</sub> +0.3	V
Voltage on OUT, FB	7	V
Peak output current, I <sub>OUT</sub>	Internally limited	
Operating ambient temperature range, T <sub>A</sub>	–40 to +150	°C
Storage temperature range, T <sub>STG</sub>	–65 to +150	°C

- (1) Stresses above these ratings may cause permanent damage. Exposure to absolute maximum conditions for extended periods may degrade device reliability. These are stress ratings only, and functional operation of the device at these or any other conditions beyond those specified is not implied.  
 (2) All voltage values are with respect to network ground terminal.

### THERMAL INFORMATION

THERMAL METRIC <sup>(1)</sup>		TPS76201-Q1	UNITS
		DBV	
		5 PINS	
θ <sub>JA</sub>	Junction-to-ambient thermal resistance	183.6	°C/W
θ <sub>JC(top)</sub>	Junction-to-case(top) thermal resistance	69.9	
θ <sub>JB</sub>	Junction-to-board thermal resistance	41.6	
ψ <sub>JT</sub>	Junction-to-top characterization parameter	2.4	
ψ <sub>JB</sub>	Junction-to-board characterization parameter	40.9	
θ <sub>JC(bottom)</sub>	Junction-to-case(bottom) thermal resistance	—	

- (1) For more information about traditional and new thermal metrics, see the *IC Package Thermal Metrics* application report, [SPRA953](http://www.ti.com/lit/spr953).

## RECOMMENDED OPERATING CONDITIONS

Over operating free-air temperature range (unless otherwise noted).

	MIN	NOM	MAX	UNIT
Input voltage range, $V_{IN}^{(1)}$	2.7		10	V
Output voltage range, $V_{OUT}^{(2)}$	0.7		5.5	V
Continuous output current, $I_{OUT}^{(2)}$	0.01		100	mA
Operating ambient temperature range, $T_A^{(2)}$	-40		+125	°C

- (1) To calculate the minimum input voltage for the desired maximum output current, use the following formula:  $V_{INmin} = V_{OUTmax} + V_{DO}$  (max load)
- (2) Continuous output current and operating junction temperature are limited by internal protection circuitry, but it is not recommended that the device operate under conditions beyond those specified in this table for extended periods of time.

## ELECTRICAL CHARACTERISTICS

Over recommended operating free-air temperature range;  $V_{IN} = V_{OUT(TYP)} + 1$  V;  $I_{OUT} = 100$  mA,  $\overline{EN} = 0$  V, and  $C_{OUT} = 4.7$   $\mu$ F, unless otherwise noted.

PARAMETER		TEST CONDITIONS	MIN	TYP	MAX	UNIT
$V_{OUT}$	10- $\mu$ A to 100-mA load <sup>(1)</sup>	$0.7$ V $\leq V_{OUT} \leq 5.5$ V, $T_J = +25^\circ$ C	$V_{OUT}$			V
		$0.7$ V $\leq V_{OUT} \leq 5.5$ V, $T_J = -40^\circ$ C to $+125^\circ$ C	$0.97 \times V_{OUT}$		$1.03 \times V_{OUT}$	V
$I_Q$	GND current <sup>(1)(2)</sup>	$\overline{EN} = 0$ V, $10 \mu$ A $< I_{OUT} < 100$ mA, $T_J = +25^\circ$ C	27			$\mu$ A
		$\overline{EN} = 0$ V, $10 \mu$ A $< I_{OUT} < 100$ mA, $T_J = -40^\circ$ C to $+125^\circ$ C	35			$\mu$ A
	Load regulation	$\overline{EN} = 0$ V, $10 \mu$ A $< I_{OUT} < 100$ mA, $T_J = +25^\circ$ C	12			mV
$\Delta V_O/V_{OUT}$	Line regulation, output voltage <sup>(2)</sup>	$2.7$ V $< V_{IN} \leq 10$ V, $T_J = +25^\circ$ C, see <sup>(1)</sup>	0.04			%/V
		$2.7$ V $< V_{IN} \leq 10$ V, $T_J = -40^\circ$ C to $+125^\circ$ C, see <sup>(1)</sup>	0.1			%/V
$V_N$	Output noise voltage	BW = 300 Hz to 50 kHz, $C_{OUT} = 10 \mu$ F, $V_{OUT} = 0.7$ V, $T_J = +25^\circ$ C	60			$\mu$ V <sub>RMS</sub>
$I_{CL}$	Output current limit	$V_{OUT} = 0$ V, see <sup>(1)</sup>		350	750	mA
$I_{STBY}$	Standby current	$\overline{EN} = V_{IN}$ , $2.7$ V $< V_{IN} \leq 10$ V	1			$\mu$ A
		$T_J = -40^\circ$ C to $+125^\circ$ C	2			$\mu$ A
$V_{EN(HI)}$	High-level enable input voltage	$2.7$ V $< V_{IN} \leq 10$ V	1.7			V
$V_{EN(LO)}$	Low-level enable input voltage	$2.7$ V $< V_{IN} \leq 10$ V	0.8			V
PSRR	Power-supply rejection ratio	$f = 1$ kHz, $C_{OUT} = 10 \mu$ F, $T_J = +25^\circ$ C, see <sup>(1)</sup>	60			dB
$I_{EN}$	Enable pin current	$\overline{EN} = 0$ V	-1	0	1	$\mu$ A
		$\overline{EN} = V_{IN}$	-1		1	$\mu$ A

- (1) Minimum IN operating voltage is 2.7 V or  $V_{OUT}(typ) + 1$  V, whichever is greater. Maximum IN voltage = 10 V, minimum output current = 10  $\mu$ A, and maximum output current = 100 mA.

- (2) If  $V_{OUT} \leq 1.8$  V, then  $V_{INmin} = 2.7$  V,  $V_{INmax} = 10$  V:  $Line\ Reg.\ (mV) = (\%/V) \times \frac{V_{OUT}(V_{Imax} - 2.7\ V)}{100} \times 1000$   
 If  $V_{OUT} \geq 2.5$  V, then  $V_{INmin} = V_{OUT} + 1$  V,  $V_{INmax} = 10$  V:  $Line\ Reg.\ (mV) = (\%/V) \times \frac{V_{OUT}[V_{Imax} - (V_{OUT} + 1\ V)]}{100} \times 1000$

### FUNCTIONAL BLOCK DIAGRAM

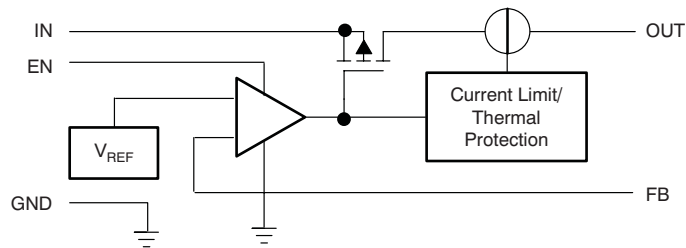
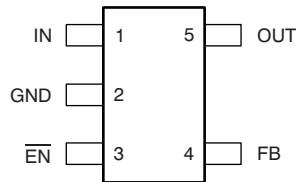

Figure 1. TPS76201-Q1

### PIN CONFIGURATION

DBV PACKAGE  
SOT-23  
(TOP VIEW)



### PIN DESCRIPTIONS

NAME	SOT-23 DBV	I/O	DESCRIPTION
IN	1	I	Input supply voltage
GND	2	—	Ground pin
$\overline{\text{EN}}$	3	I	Enable input
OUT	4	I	Regulated output voltage
FB	5	O	Feedback voltage

**TYPICAL CHARACTERISTICS**

At  $T_J = -40^\circ\text{C}$  to  $+125^\circ\text{C}$ ,  $V_{IN} = V_{OUT(TYP)} + 0.5\text{ V}$  or  $2.0\text{ V}$ , whichever is greater;  $I_{OUT} = 10\text{ mA}$ ,  $V_{EN} = V_{IN}$ ,  $C_{OUT} = 1.0\ \mu\text{F}$ , unless otherwise noted. Typical values are at  $T_J = +25^\circ\text{C}$ .

**OUTPUT VOLTAGE vs  
OUTPUT CURRENT**

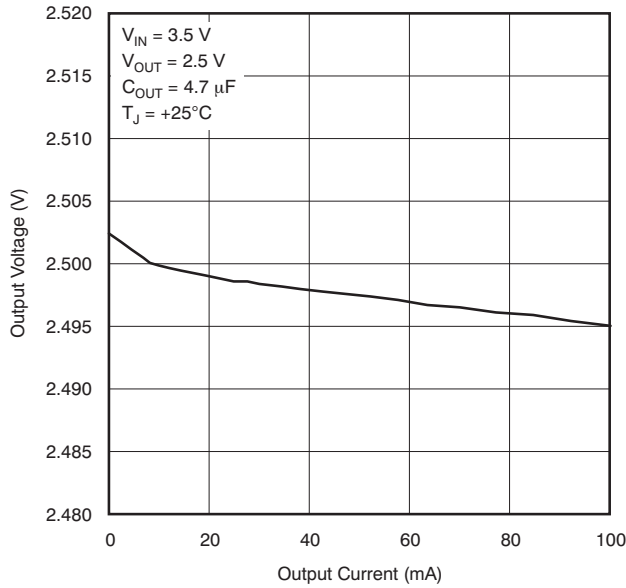

**Figure 2.**

**OUTPUT VOLTAGE vs  
OUTPUT CURRENT**

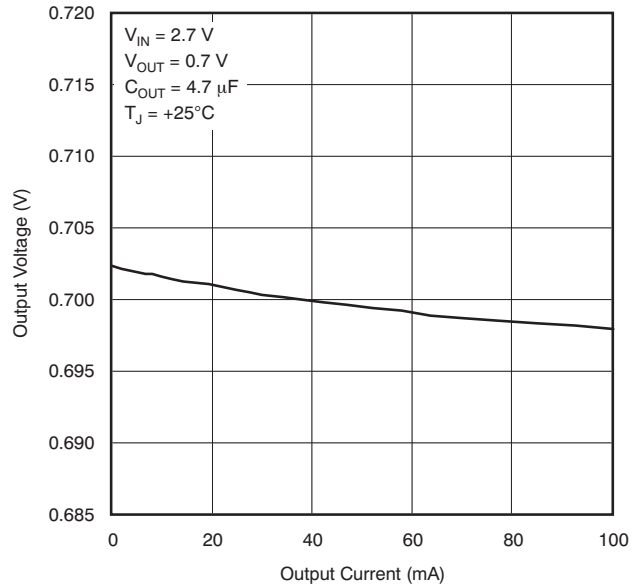

**Figure 3.**

**OUTPUT VOLTAGE vs  
JUNCTION TEMPERATURE**

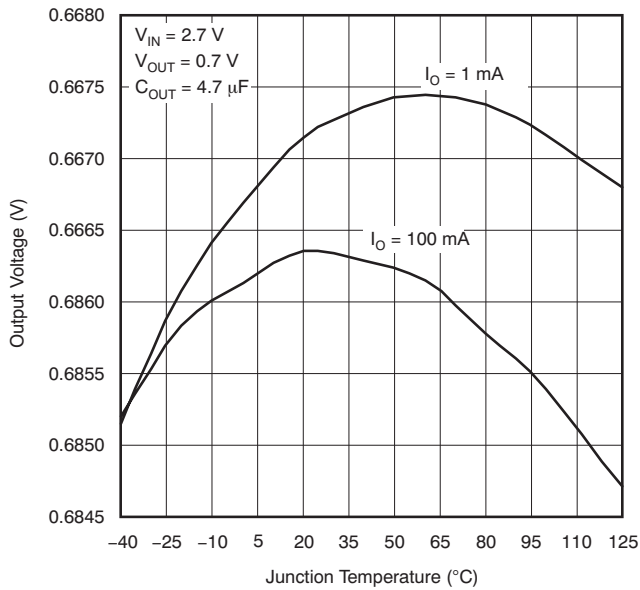

**Figure 4.**

**GROUND CURRENT vs  
JUNCTION TEMPERATURE**

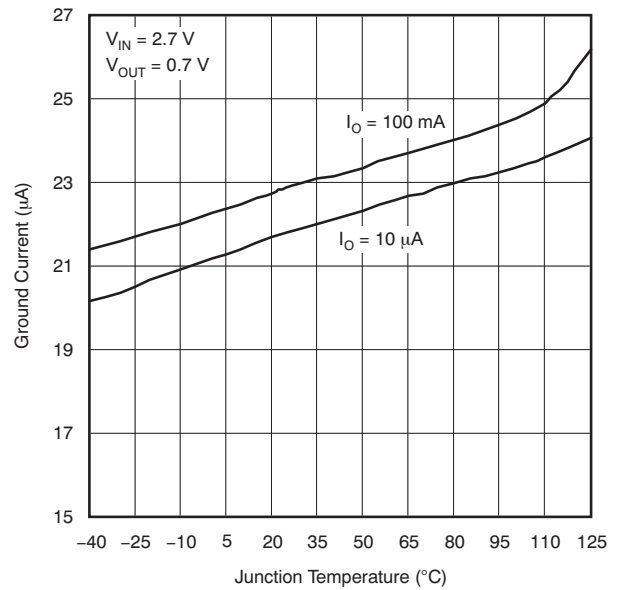
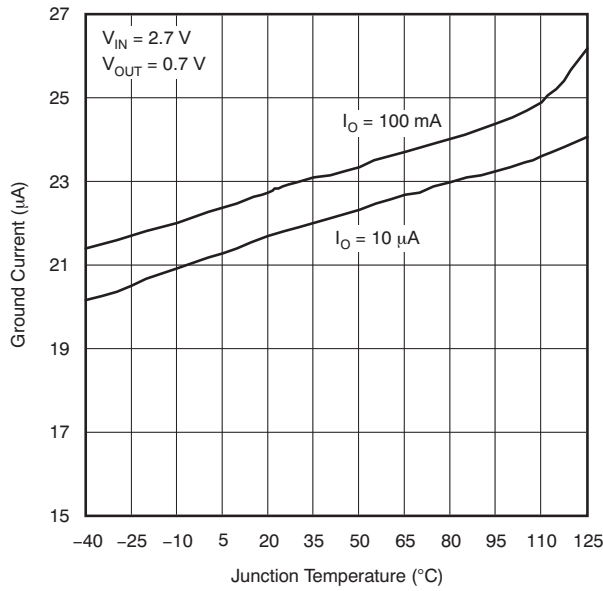

**Figure 5.**

**TYPICAL CHARACTERISTICS (continued)**

At  $T_J = -40^\circ\text{C}$  to  $+125^\circ\text{C}$ ,  $V_{IN} = V_{OUT(TYP)} + 0.5\text{ V}$  or  $2.0\text{ V}$ , whichever is greater;  $I_{OUT} = 10\text{ mA}$ ,  $V_{EN} = V_{IN}$ ,  $C_{OUT} = 1.0\text{ }\mu\text{F}$ , unless otherwise noted. Typical values are at  $T_J = +25^\circ\text{C}$ .

**OUTPUT SPECTRAL NOISE DENSITY vs FREQUENCY**



**Figure 6.**

**OUTPUT IMPEDANCE vs FREQUENCY**

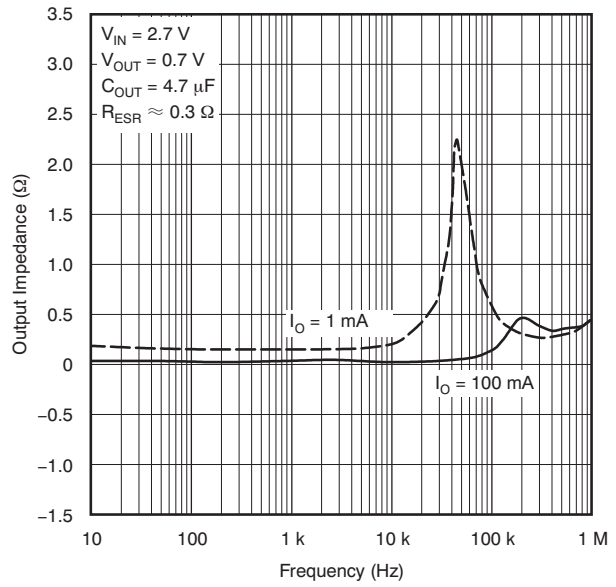

**Figure 7.**

**DROPOUT VOLTAGE vs INPUT VOLTAGE**

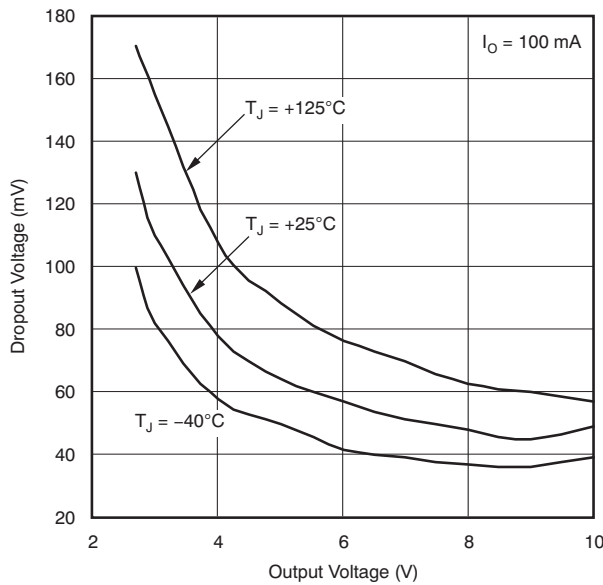

**Figure 8.**

**DROPOUT VOLTAGE vs JUNCTION TEMPERATURE**

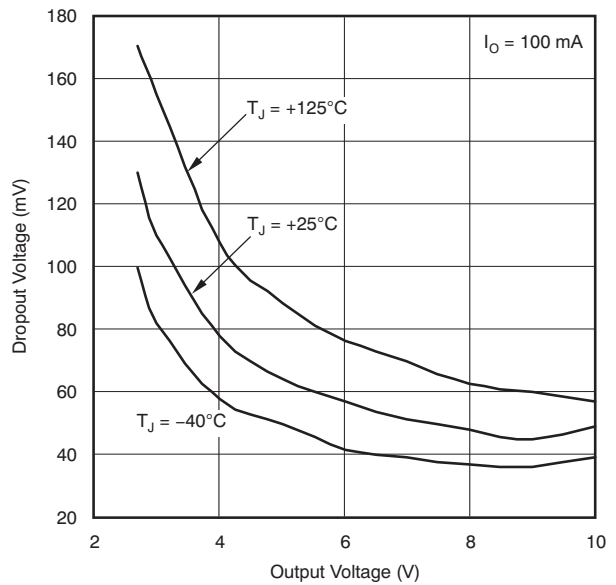

**Figure 9.**

**TYPICAL CHARACTERISTICS (continued)**

At  $T_J = -40^\circ\text{C}$  to  $+125^\circ\text{C}$ ,  $V_{IN} = V_{OUT(TYP)} + 0.5\text{ V}$  or  $2.0\text{ V}$ , whichever is greater;  $I_{OUT} = 10\text{ mA}$ ,  $V_{EN} = V_{IN}$ ;  $C_{OUT} = 1.0\text{ }\mu\text{F}$ , unless otherwise noted. Typical values are at  $T_J = +25^\circ\text{C}$ .

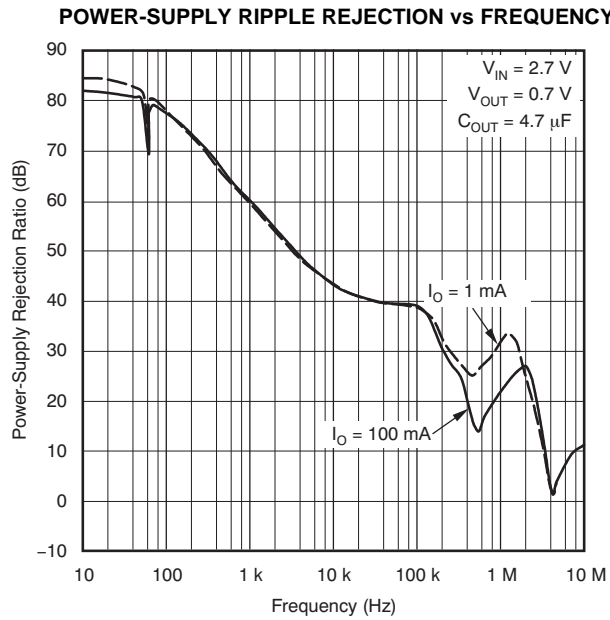

Figure 10.

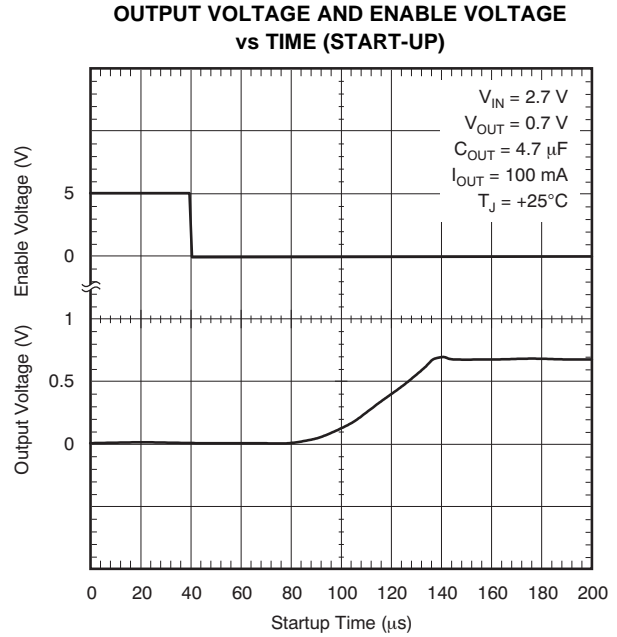

Figure 11.

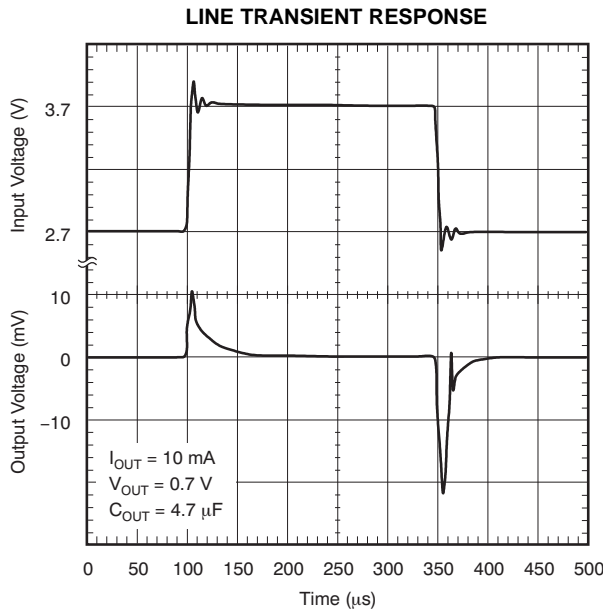

Figure 12.

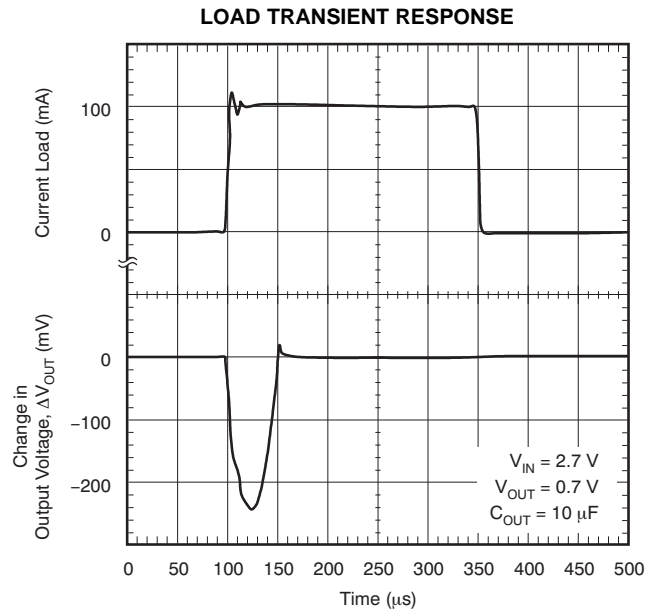
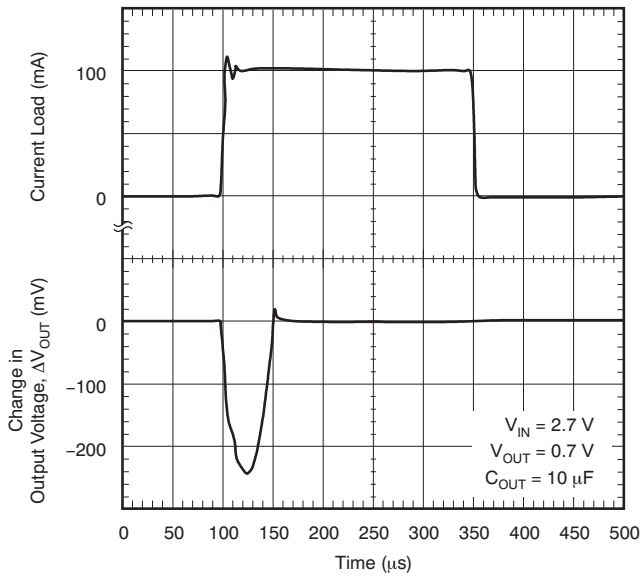

Figure 13.

**TYPICAL CHARACTERISTICS (continued)**

At  $T_J = -40^{\circ}\text{C}$  to  $+125^{\circ}\text{C}$ ,  $V_{IN} = V_{OUT(TYP)} + 0.5\text{ V}$  or  $2.0\text{ V}$ , whichever is greater;  $I_{OUT} = 10\text{ mA}$ ,  $V_{EN} = V_{IN}$ ,  $C_{OUT} = 1.0\text{ }\mu\text{F}$ , unless otherwise noted. Typical values are at  $T_J = +25^{\circ}\text{C}$ .

**LINE TRANSIENT RESPONSE**



**Figure 14.**

**LOAD TRANSIENT RESPONSE**

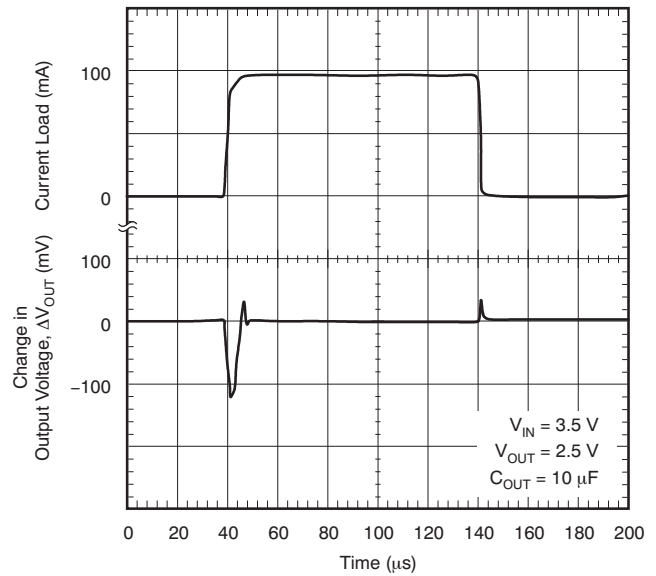

**Figure 15.**

**TYPICAL REGIONS OF STABILITY  
EQUIVALENT SERIES RESISTANCE (ESR)  
vs OUTPUT CURRENT**

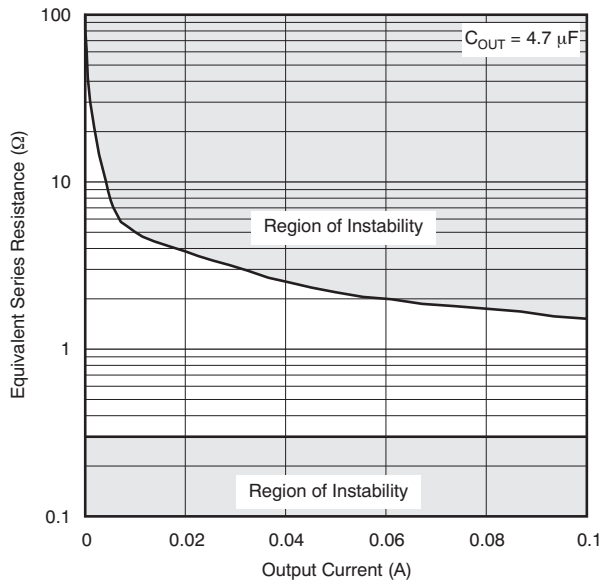

**Figure 16.**

**TYPICAL REGIONS OF STABILITY  
EQUIVALENT SERIES RESISTANCE (ESR)  
vs OUTPUT CURRENT**

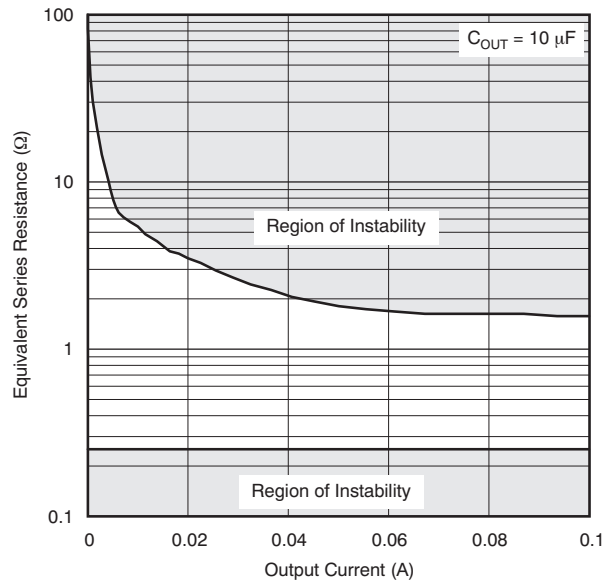
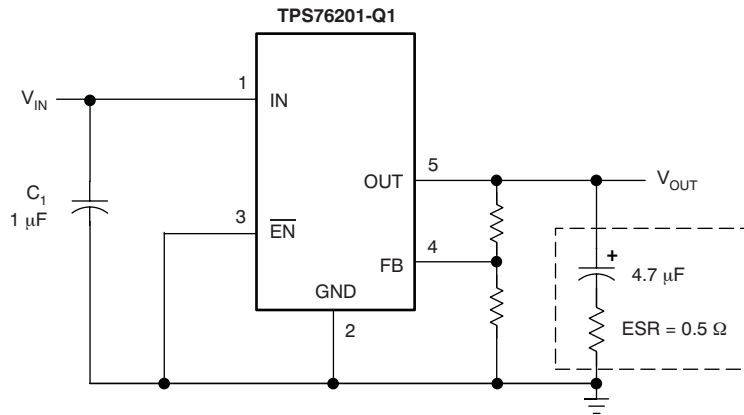

**Figure 17.**



## APPLICATION INFORMATION

The TPS76201-Q1 low-dropout (LDO) regulator has been optimized for use in battery-operated equipment including, but not limited to, the sub 1.2-V DSP core voltage supplies. It features low quiescent current (23  $\mu\text{A}$  nominally) and enable inputs to reduce supply currents to 1  $\mu\text{A}$  when the regulators are turned off. A typical application circuit is shown in Figure 18.



**Figure 18. Typical Application Circuit**

### External Capacitor Requirements

Although not required, a 0.047- $\mu\text{F}$  or larger ceramic input bypass capacitor, connected between IN and GND and located close to the TPS76201-Q1, is recommended to improve transient response and noise rejection. A higher-value electrolytic input capacitor may be necessary if large, fast-rise-time load transients are anticipated and the device is located several inches from the power source.

Like all low dropout regulators, the TPS76201-Q1 requires an output capacitor connected between OUT and GND to stabilize the internal control loop. The minimum recommended capacitance is 4.7  $\mu\text{F}$ . The equivalent series resistance (ESR) of the capacitor should be between 0.3  $\Omega$  and 1.5  $\Omega$  to ensure stability. Capacitor values larger than 4.7  $\mu\text{F}$  are acceptable, and allow the use of smaller ESR values. Capacitors less than 4.7  $\mu\text{F}$  are not recommended because they require careful selection of ESR to ensure stability. Solid tantalum electrolytic, aluminum electrolytic, and multilayer ceramic capacitors are all suitable, provided they meet the requirements described above. Most of the commercially available 4.7- $\mu\text{F}$  surface-mount solid tantalum capacitors, including devices from Sprague, Kemet, and Nichico, meet these ESR requirements. Multilayer ceramic capacitors may have very small equivalent series resistances and therefore may require the addition of a low-value series resistor to ensure stability. Table 1 summarizes the capacitor selection recommendations.

**Table 1. Capacitor Selection**

PART NO.	MFR	VALUE	MAX ESR <sup>(1)</sup>	SIZE (H x L x W) <sup>(2)</sup>
T494B475K016AS	KEMET	4.7 $\mu\text{F}$	1.5 $\Omega$	1.9 x 3.5 x 2.8
195D106x0016x2T	SPRAGUE	10 $\mu\text{F}$	1.5 $\Omega$	1.3 x 7.0 x 2.7
695D106x003562T	SPRAGUE	10 $\mu\text{F}$	1.3 $\Omega$	2.5 x 7.6 x 2.5
TPSC475K035R0600	AVX	4.7 $\mu\text{F}$	0.6 $\Omega$	2.6 x 6.0 x 3.2

(1) ESR is maximum resistance in Ohms at 100 kHz and  $T_A = +25^\circ\text{C}$ . Contact manufacturer for minimum ESR values.

(2) Size is shown in mm.

### Output Voltage Programming

The output voltage of the TPS76201-Q1 adjustable regulator is programmed using an external resistor divider as shown in [Figure 19](#). The output voltage is calculated using:

$$V_{OUT} = V_{REF} \times \left( 1 + \frac{R1}{R2} \right) \tag{1}$$

Where:

$$V_{REF} = 0.6663 \text{ V, typ (the internal reference voltage)}$$

Resistors R1 and R2 should be chosen for approximately 10-μA divider current. Lower value resistors can be used but offer no inherent advantage and waste more power. Higher values should be avoided because leakage currents at FB increase the output voltage error. The recommended design procedure is to choose R2 = 66.5 kΩ to set the divider current at 10 μA and then calculate R1 using [Equation 2](#):

$$R1 = \left( \frac{V_{OUT}}{V_{REF}} - 1 \right) \times R2 \tag{2}$$

**OUTPUT VOLTAGE PROGRAMMING GUIDE**

OUTPUT VOLTAGE (V)	DIVIDER RESISTANCE (kΩ) <sup>(1)</sup>	
	R1	R2
0.7	3.36	66.5
0.9	23.2	66.5
1.2	53.6	66.5
1.5	83.5	66.5
1.8	113	66.5
2.5	182	66.5
3.3	246	66.5
3.6	294	66.5
4	332	66.5
5	432	66.5

(1) 1% values shown.

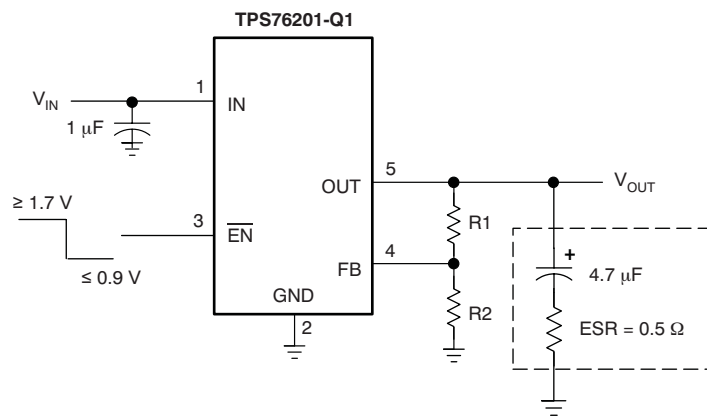

**Figure 19. TPS76201-Q1 Adjustable LDO Regulator Programming**

### Power Dissipation and Junction Temperature

Specified regulator operation is assured to a junction temperature of +125°C; the maximum junction temperature should be restricted to +150°C under normal operating conditions. This restriction limits the power dissipation the regulator can handle in any given application. To ensure the junction temperature is within acceptable limits, calculate the maximum allowable dissipation, P<sub>D(max)</sub>, and the actual dissipation, P<sub>D</sub>, which must be less than or equal to P<sub>D(max)</sub>.

The maximum power dissipation limit is determined using [Equation 3](#):

$$P_{D(max)} = \frac{T_{J(max)} - T_A}{R_{\theta JA}} \tag{3}$$

Where:

T<sub>Jmax</sub> is the maximum allowable junction temperature.

R<sub>θJA</sub> is the thermal resistance junction-to-ambient for the package; see the [Thermal Information](#) table.

T<sub>A</sub> is the ambient temperature.

The regulator dissipation is calculated using [Equation 4](#):

$$P_D = (V_{IN} - V_{OUT}) \times I_{OUT} \quad (4)$$

Power dissipation resulting from quiescent current is negligible. Excessive power dissipation triggers the thermal protection circuit.

### Regulator Protection

The TPS76201-Q1 PMOS-pass transistor has a built-in back diode that conducts reverse current when the input voltage drops below the output voltage (for example, during power down). Current is conducted from the output to the input and is not internally limited. If extended reverse voltage operation is anticipated, external limiting might be appropriate.

The TPS76201-Q1 features internal current limiting and thermal protection. During normal operation, the TPS76201-Q1 limits output current to approximately 350 mA. When current limiting engages, the output voltage scales back linearly until the overcurrent condition ends. While current limiting is designed to prevent gross device failure, care should be taken not to exceed the power dissipation ratings of the package. If the temperature of the device exceeds approximately +165°C, thermal protection circuitry shuts it down. Once the device has cooled to below approximately +140°C, regulator operation resumes.

**PACKAGING INFORMATION**

Orderable Device	Status (1)	Package Type	Package Drawing	Pins	Package Qty	Eco Plan (2)	Lead/Ball Finish (6)	MSL Peak Temp (3)	Op Temp (°C)	Device Marking (4/5)	Samples
TPS76201QDBVRQ1	ACTIVE	SOT-23	DBV	5	3000	Green (RoHS & no Sb/Br)	NIPDAU	Level-1-260C-UNLIM	-40 to 125	PUEQ	<b>Samples</b>

(1) The marketing status values are defined as follows:

**ACTIVE:** Product device recommended for new designs.

**LIFEBUY:** TI has announced that the device will be discontinued, and a lifetime-buy period is in effect.

**NRND:** Not recommended for new designs. Device is in production to support existing customers, but TI does not recommend using this part in a new design.

**PREVIEW:** Device has been announced but is not in production. Samples may or may not be available.

**OBSOLETE:** TI has discontinued the production of the device.

(2) **RoHS:** TI defines "RoHS" to mean semiconductor products that are compliant with the current EU RoHS requirements for all 10 RoHS substances, including the requirement that RoHS substance do not exceed 0.1% by weight in homogeneous materials. Where designed to be soldered at high temperatures, "RoHS" products are suitable for use in specified lead-free processes. TI may reference these types of products as "Pb-Free".

**RoHS Exempt:** TI defines "RoHS Exempt" to mean products that contain lead but are compliant with EU RoHS pursuant to a specific EU RoHS exemption.

**Green:** TI defines "Green" to mean the content of Chlorine (Cl) and Bromine (Br) based flame retardants meet JS709B low halogen requirements of <=1000ppm threshold. Antimony trioxide based flame retardants must also meet the <=1000ppm threshold requirement.

(3) MSL, Peak Temp. - The Moisture Sensitivity Level rating according to the JEDEC industry standard classifications, and peak solder temperature.

(4) There may be additional marking, which relates to the logo, the lot trace code information, or the environmental category on the device.

(5) Multiple Device Markings will be inside parentheses. Only one Device Marking contained in parentheses and separated by a "~" will appear on a device. If a line is indented then it is a continuation of the previous line and the two combined represent the entire Device Marking for that device.

(6) Lead/Ball Finish - Orderable Devices may have multiple material finish options. Finish options are separated by a vertical ruled line. Lead/Ball Finish values may wrap to two lines if the finish value exceeds the maximum column width.

**Important Information and Disclaimer:**The information provided on this page represents TI's knowledge and belief as of the date that it is provided. TI bases its knowledge and belief on information provided by third parties, and makes no representation or warranty as to the accuracy of such information. Efforts are underway to better integrate information from third parties. TI has taken and continues to take reasonable steps to provide representative and accurate information but may not have conducted destructive testing or chemical analysis on incoming materials and chemicals. TI and TI suppliers consider certain information to be proprietary, and thus CAS numbers and other limited information may not be available for release.

In no event shall TI's liability arising out of such information exceed the total purchase price of the TI part(s) at issue in this document sold by TI to Customer on an annual basis.

**OTHER QUALIFIED VERSIONS OF TPS76201-Q1 :**

- Catalog: [TPS76201](#)

NOTE: Qualified Version Definitions:

- Catalog - TI's standard catalog product

## TAPE AND REEL INFORMATION



### QUADRANT ASSIGNMENTS FOR PIN 1 ORIENTATION IN TAPE



\*All dimensions are nominal

Device	Package Type	Package Drawing	Pins	SPQ	Reel Diameter (mm)	Reel Width W1 (mm)	A0 (mm)	B0 (mm)	K0 (mm)	P1 (mm)	W (mm)	Pin1 Quadrant
TPS76201QDBVRQ1	SOT-23	DBV	5	3000	179.0	8.4	3.2	3.2	1.4	4.0	8.0	Q3

TAPE AND REEL BOX DIMENSIONS



\*All dimensions are nominal

Device	Package Type	Package Drawing	Pins	SPQ	Length (mm)	Width (mm)	Height (mm)
TPS76201QDBVRQ1	SOT-23	DBV	5	3000	203.0	203.0	35.0





# EXAMPLE BOARD LAYOUT

DBV0005A

SOT-23 - 1.45 mm max height

SMALL OUTLINE TRANSISTOR



LAND PATTERN EXAMPLE  
EXPOSED METAL SHOWN  
SCALE:15X

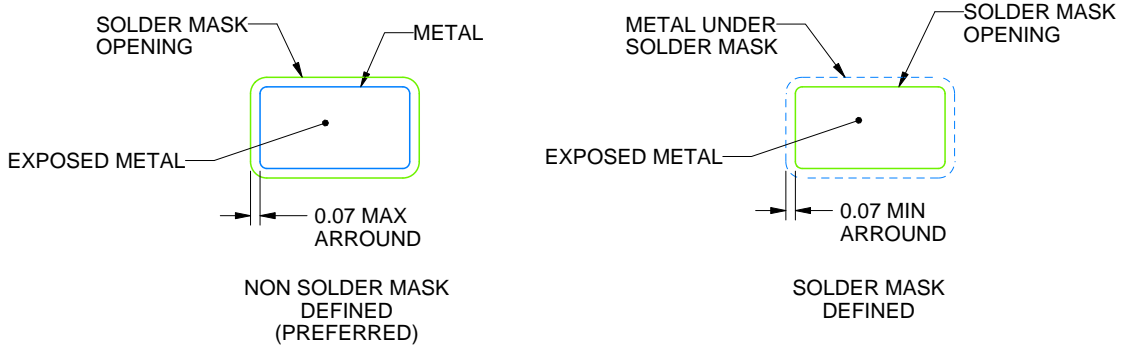

SOLDER MASK DETAILS

4214839/E 09/2019

NOTES: (continued)

- 5. Publication IPC-7351 may have alternate designs.
- 6. Solder mask tolerances between and around signal pads can vary based on board fabrication site.

# EXAMPLE STENCIL DESIGN

DBV0005A

SOT-23 - 1.45 mm max height

SMALL OUTLINE TRANSISTOR



SOLDER PASTE EXAMPLE  
BASED ON 0.125 mm THICK STENCIL  
SCALE:15X

4214839/E 09/2019

NOTES: (continued)

7. Laser cutting apertures with trapezoidal walls and rounded corners may offer better paste release. IPC-7525 may have alternate design recommendations.
8. Board assembly site may have different recommendations for stencil design.

## IMPORTANT NOTICE AND DISCLAIMER

TI PROVIDES TECHNICAL AND RELIABILITY DATA (INCLUDING DATASHEETS), DESIGN RESOURCES (INCLUDING REFERENCE DESIGNS), APPLICATION OR OTHER DESIGN ADVICE, WEB TOOLS, SAFETY INFORMATION, AND OTHER RESOURCES "AS IS" AND WITH ALL FAULTS, AND DISCLAIMS ALL WARRANTIES, EXPRESS AND IMPLIED, INCLUDING WITHOUT LIMITATION ANY IMPLIED WARRANTIES OF MERCHANTABILITY, FITNESS FOR A PARTICULAR PURPOSE OR NON-INFRINGEMENT OF THIRD PARTY INTELLECTUAL PROPERTY RIGHTS.

These resources are intended for skilled developers designing with TI products. You are solely responsible for (1) selecting the appropriate TI products for your application, (2) designing, validating and testing your application, and (3) ensuring your application meets applicable standards, and any other safety, security, or other requirements. These resources are subject to change without notice. TI grants you permission to use these resources only for development of an application that uses the TI products described in the resource. Other reproduction and display of these resources is prohibited. No license is granted to any other TI intellectual property right or to any third party intellectual property right. TI disclaims responsibility for, and you will fully indemnify TI and its representatives against, any claims, damages, costs, losses, and liabilities arising out of your use of these resources.

TI's products are provided subject to TI's Terms of Sale ([www.ti.com/legal/termsofsale.html](http://www.ti.com/legal/termsofsale.html)) or other applicable terms available either on [ti.com](http://ti.com) or provided in conjunction with such TI products. TI's provision of these resources does not expand or otherwise alter TI's applicable warranties or warranty disclaimers for TI products.

Mailing Address: Texas Instruments, Post Office Box 655303, Dallas, Texas 75265  
Copyright © 2020, Texas Instruments Incorporated