

- Output Swing Includes Both Supply Rails
- Low Noise . . . 15 nV/√Hz Typ at f = 1 kHz
- Low Input Bias Current . . . 1 pA Typ
- Fully Specified for Single-Supply 3-V and 5-V Operation
- Common-Mode Input Voltage Range Includes Negative Rail
- High Gain Bandwidth . . . 2 MHz at $V_{DD} = 5\text{ V}$ With 600-Ω Load
- High Slew Rate . . . 1.6 V/μs at $V_{DD} = 5\text{ V}$
- Wide Supply Voltage Range 2.7 V to 10 V
- Macromodel Included

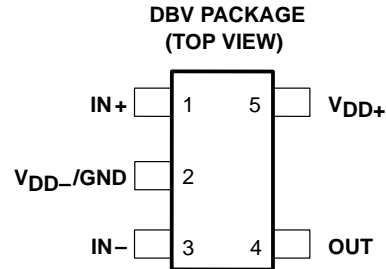

description

The TLV2231 is a single low-voltage operational amplifier available in the SOT-23 package. It offers 2 MHz of bandwidth and 1.6 V/μs of slew rate for applications requiring good ac performance. The device exhibits rail-to-rail output performance for increased dynamic range in single or split supply applications. The TLV2231 is fully characterized at 3 V and 5 V and is optimized for low-voltage applications.

The TLV2231, exhibiting high input impedance and low noise, is excellent for small-signal conditioning of high-impedance sources, such as piezoelectric transducers. Because of the micropower dissipation levels combined with 3-V operation, these devices work well in hand-held monitoring and remote-sensing applications. In addition, the rail-to-rail output feature with single- or split-supplies makes this family a great choice when interfacing with analog-to-digital converters (ADCs). The device can also drive 600-Ω loads for telecom applications.

With a total area of 5.6mm², the SOT-23 package only requires one-third the board space of the standard 8-pin SOIC package. This ultra-small package allows designers to place single amplifiers very close to the signal source, minimizing noise pick-up from long PCB traces. TI has also taken special care to provide a pinout that is optimized for board layout (see Figure 1). Both inputs are separated by GND to prevent coupling or leakage paths. The OUT and IN– terminals are on the same end of the board for providing negative feedback. Finally, gain setting resistors and the decoupling capacitor are easily placed around the package.

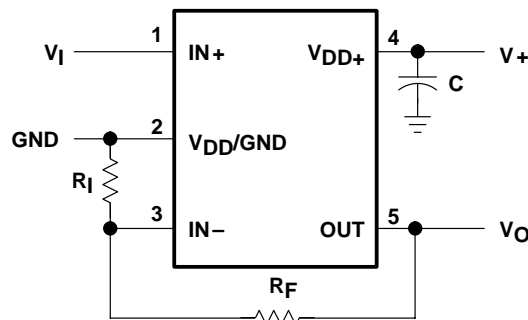

Figure 1. Typical Surface Mount Layout for a Fixed-Gain Noninverting Amplifier



Please be aware that an important notice concerning availability, standard warranty, and use in critical applications of Texas Instruments semiconductor products and disclaimers thereto appears at the end of this data sheet.

Advanced LinCMOS is a trademark of Texas Instruments.

PRODUCTION DATA information is current as of publication date. Products conform to specifications per the terms of Texas Instruments standard warranty. Production processing does not necessarily include testing of all parameters.

 **TEXAS
INSTRUMENTS**

POST OFFICE BOX 655303 • DALLAS, TEXAS 75265

Copyright © 2001, Texas Instruments Incorporated

TLV2231, TLV2231Y
Advanced LinCMOS™ RAIL-TO-RAIL
LOW-POWER SINGLE OPERATIONAL AMPLIFIERS

SLOS158D – JUNE 1996 – REVISED APRIL 2001

AVAILABLE OPTIONS

T _A	V _{IO} max AT 25°C	PACKAGED DEVICES	SYMBOL	CHIP FORM‡ (Y)
		SOT-23 (DBV)†		
0°C to 70°C	3 mV	TLV2231CDBV	VAEC	TLV2231Y
-40°C to 85°C	3 mV	TLV2231IDBV	VAEI	

† The DBV package available in tape and reel only.

‡ Chip forms are tested at T_A = 25°C only.

TLV2231Y chip information

This chip, when properly assembled, displays characteristics similar to the TLV2231C. Thermal compression or ultrasonic bonding may be used on the doped-aluminum bonding pads. This chip may be mounted with conductive epoxy or a gold-silicon preform.

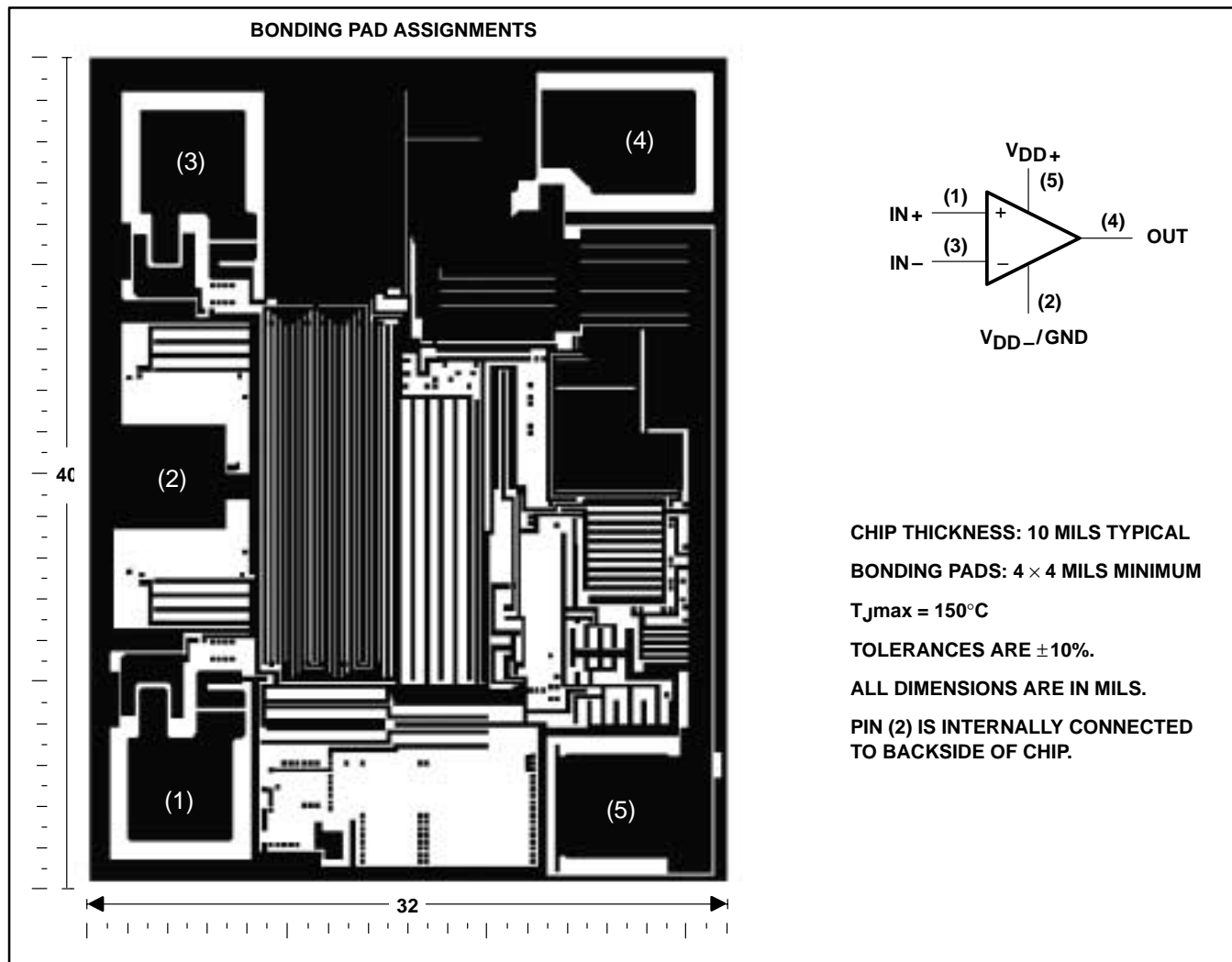

equivalent schematic

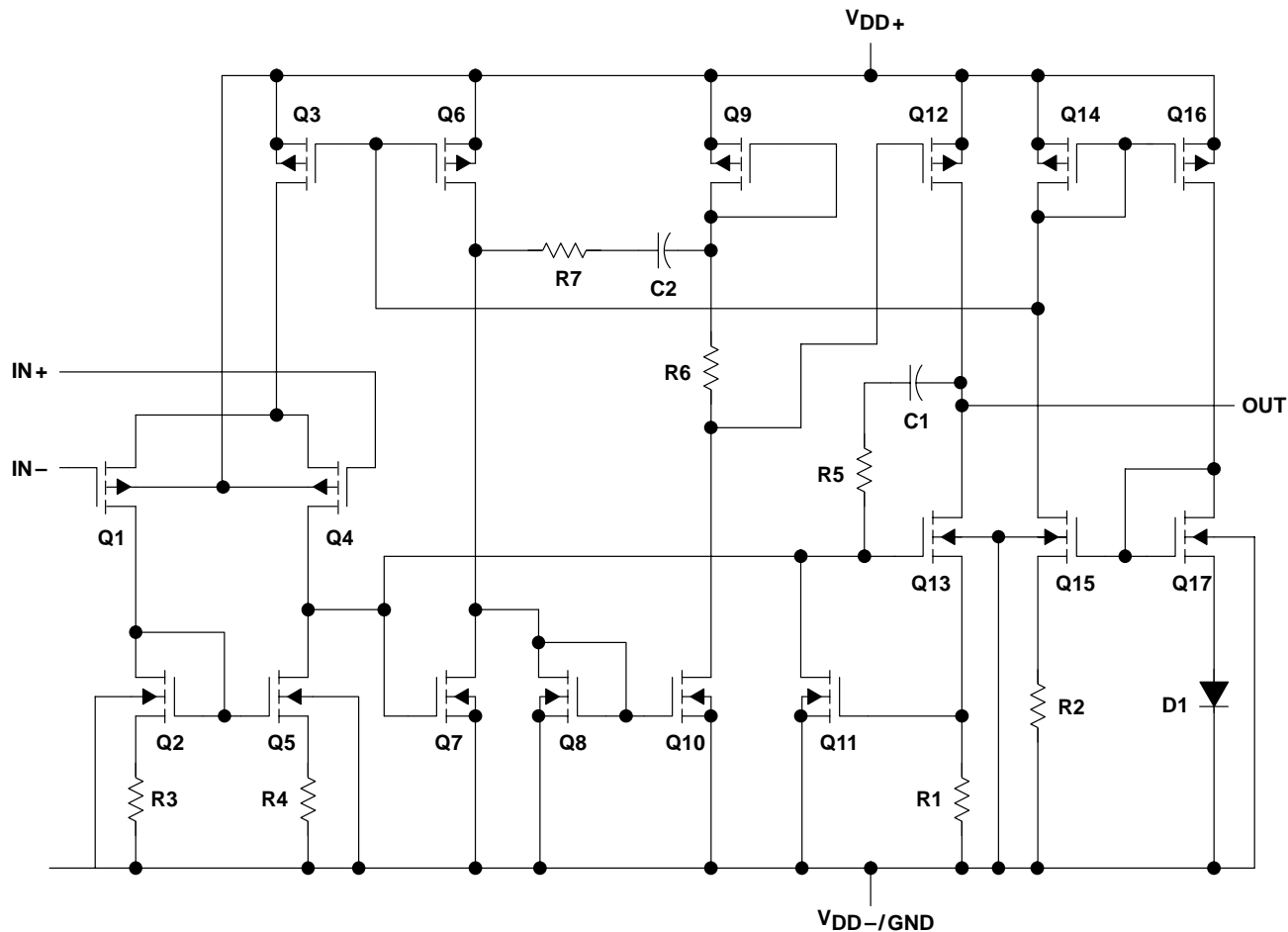

COMPONENT COUNT†	
Transistors	23
Diodes	5
Resistors	11
Capacitors	2

† Includes both amplifiers and all ESD, bias, and trim circuitry

TLV2231, TLV2231Y
Advanced LinCMOS™ RAIL-TO-RAIL
LOW-POWER SINGLE OPERATIONAL AMPLIFIERS

SLOS158D – JUNE 1996 – REVISED APRIL 2001

absolute maximum ratings over operating free-air temperature range (unless otherwise noted)†

Supply voltage, V_{DD} (see Note 1)	12 V
Differential input voltage, V_{ID} (see Note 2)	$\pm V_{DD}$
Input voltage range, V_I (any input, see Note 1)	-0.3 V to V_{DD}
Input current, I_I (each input)	± 5 mA
Output current, I_O	± 50 mA
Total current into V_{DD+}	± 50 mA
Total current out of V_{DD-}	± 50 mA
Duration of short-circuit current (at or below) 25°C (see Note 3)	unlimited
Continuous total power dissipation	See Dissipation Rating Table
Operating free-air temperature range, T_A : TLV2231C	0°C to 70°C
TLV2231I	-40°C to 85°C
Storage temperature range, T_{stg}	-65°C to 150°C
Lead temperature 1,6 mm (1/16 inch) from case for 10 seconds: DBV package	260°C

† Stresses beyond those listed under “absolute maximum ratings” may cause permanent damage to the device. These are stress ratings only, and functional operation of the device at these or any other conditions beyond those indicated under “recommended operating conditions” is not implied. Exposure to absolute-maximum-rated conditions for extended periods may affect device reliability.

- NOTES: 1. All voltage values, except differential voltages, are with respect to V_{DD-} .
 2. Differential voltages are at the noninverting input with respect to the inverting input. Excessive current flows when input is brought below $V_{DD-} - 0.3$ V.
 3. The output may be shorted to either supply. Temperature and/or supply voltages must be limited to ensure that the maximum dissipation rating is not exceeded.

DISSIPATION RATING TABLE

PACKAGE	$T_A \leq 25^\circ\text{C}$ POWER RATING	DERATING FACTOR ABOVE $T_A = 25^\circ\text{C}$	$T_A = 70^\circ\text{C}$ POWER RATING	$T_A = 85^\circ\text{C}$ POWER RATING
DBV	150 mW	1.2 mW/°C	96 mW	78 mW

recommended operating conditions

	TLV2231C		TLV2231I		UNIT
	MIN	MAX	MIN	MAX	
Supply voltage, V_{DD} (see Note 1)	2.7	10	2.7	10	V
Input voltage range, V_I	V_{DD-}	$V_{DD+} - 1.3$	V_{DD-}	$V_{DD+} - 1.3$	V
Common-mode input voltage, V_{IC}	V_{DD-}	$V_{DD+} - 1.3$	V_{DD-}	$V_{DD+} - 1.3$	V
Operating free-air temperature, T_A	0	70	-40	85	°C

NOTE 1: All voltage values, except differential voltages, are with respect to V_{DD-} .



TLV2231, TLV2231Y
Advanced LinCMOS™ RAIL-TO-RAIL
LOW-POWER SINGLE OPERATIONAL AMPLIFIERS

SLOS158D – JUNE 1996 – REVISED APRIL 2001

electrical characteristics at specified free-air temperature, $V_{DD} = 3\text{ V}$ (unless otherwise noted)

PARAMETER	TEST CONDITIONS	T_A †	TLV2231C			TLV2231I			UNIT
			MIN	TYP	MAX	MIN	TYP	MAX	
V_{IO} Input offset voltage	$V_{DD\pm} = \pm 1.5\text{ V}$, $V_{IC} = 0$, $V_O = 0$, $R_S = 50\ \Omega$	Full range	0.75		3	0.75		3	mV
$\alpha_{V_{IO}}$ Temperature coefficient of input offset voltage			0.5		0.5		$\mu\text{V}/^\circ\text{C}$		
Input offset voltage long-term drift (see Note 4)		25°C	0.003		0.003		$\mu\text{V}/\text{mo}$		
I_{IO} Input offset current		25°C	0.5	60	0.5	60	pA		
		Full range	150		150				
I_{IB} Input bias current		25°C	1	60	1	60	pA		
	Full range	150		150					
V_{ICR} Common-mode input voltage range	$R_S = 50\ \Omega$, $ V_{IO} \leq 5\text{ mV}$	25°C	0 to 2	-0.3 to 2.2	0 to 2	-0.3 to 2.2	V		
		Full range	0 to 1.7	0 to 1.7	0 to 1.7	0 to 1.7			
V_{OH} High-level output voltage	$I_{OH} = -1\text{ mA}$ $I_{OH} = -2\text{ mA}$	25°C	2.87		2.87		V		
		25°C	2.74		2.74				
		Full range	2		2				
V_{OL} Low-level output voltage	$V_{IC} = 1.5\text{ V}$, $I_{OL} = 50\ \mu\text{A}$ $V_{IC} = 1.5\text{ V}$, $I_{OL} = 500\ \mu\text{A}$	25°C	10		10		mV		
		25°C	100		100				
		Full range	300		300				
A_{VD} Large-signal differential voltage amplification	$V_{IC} = 1.5\text{ V}$, $V_O = 1\text{ V to } 2\text{ V}$	25°C	$R_L = 600\ \Omega$ ‡		1 1.6		V/mV		
			Full range		0.3				
		25°C	$R_L = 1\text{ M}\Omega$ ‡		250				
r_{id} Differential input resistance		25°C	10^{12}		10^{12}		Ω		
r_{ic} Common-mode input resistance		25°C	10^{12}		10^{12}		Ω		
c_{ic} Common-mode input capacitance	$f = 10\text{ kHz}$	25°C	6		6		pF		
z_o Closed-loop output impedance	$f = 1\text{ MHz}$, $A_V = 1$	25°C	156		156		Ω		
CMRR Common-mode rejection ratio	$V_{IC} = 0\text{ to } 1.7\text{ V}$, $V_O = 1.5\text{ V}$, $R_S = 50\ \Omega$	25°C	60	70	60	70	dB		
		Full range	55		55				
k_{SVR} Supply voltage rejection ratio ($\Delta V_{DD} / \Delta V_{IO}$)	$V_{DD} = 2.7\text{ V to } 8\text{ V}$, $V_{IC} = V_{DD}/2$, No load	25°C	70	96	70	96	dB		
		Full range	70		70				
I_{DD} Supply current	$V_O = 1.5\text{ V}$, No load	25°C	750	1200	750	1200	μA		
		Full range	1500		1500				

† Full range for the TLV2231C is 0°C to 70°C. Full range for the TLV2231I is -40°C to 85°C.

‡ Referenced to 1.5 V

NOTE 4: Typical values are based on the input offset voltage shift observed through 500 hours of operating life test at $T_A = 150^\circ\text{C}$ extrapolated to $T_A = 25^\circ\text{C}$ using the Arrhenius equation and assuming an activation energy of 0.96 eV.



TLV2231, TLV2231Y
Advanced LinCMOS™ RAIL-TO-RAIL
LOW-POWER SINGLE OPERATIONAL AMPLIFIERS

SLOS158D – JUNE 1996 – REVISED APRIL 2001

electrical characteristics at specified free-air temperature, $V_{DD} = 5\text{ V}$ (unless otherwise noted)

PARAMETER	TEST CONDITIONS	T_A †	TLV2231C			TLV2231I			UNIT
			MIN	TYP	MAX	MIN	TYP	MAX	
V_{IO} Input offset voltage	$V_{DD} = \pm 2.5\text{ V}$, $V_O = 0$, $V_{IC} = 0$, $R_S = 50\ \Omega$	Full range	0.71	3		0.71	3		mV
αV_{IO} Temperature coefficient of input offset voltage			0.5			0.5			$\mu\text{V}/^\circ\text{C}$
Input offset voltage long-term drift (see Note 4)		25°C	0.003			0.003			$\mu\text{V}/\text{mo}$
I_{IO} Input offset current		25°C	0.5	60		0.5	60		pA
		Full range	150			150			
I_{IB} Input bias current		25°C	1	60		1	60		pA
	Full range	150			150				
V_{ICR} Common-mode input voltage range	$R_S = 50\ \Omega$, $ V_{IO} \leq 5\text{ mV}$	25°C	0 to 4	-0.3 to 4.2		0 to 4	-0.3 to 4.2		V
		Full range	0 to 3.7		0 to 3.7				
V_{OH} High-level output voltage	$I_{OH} = -1\text{ mA}$	25°C	4.9			4.9			V
	$I_{OH} = -4\text{ mA}$	25°C	4.6			4.6			
	Full range	4			4				
V_{OL} Low-level output voltage	$V_{IC} = 2.5\text{ V}$, $I_{OL} = 500\ \mu\text{A}$	25°C	80			80			mV
	$V_{IC} = 2.5\text{ V}$, $I_{OL} = 1\text{ mA}$	25°C	160			160			
	Full range	500			500				
A_{VD} Large-signal differential voltage amplification	$V_{IC} = 2.5\text{ V}$, $V_O = 1\text{ V to }4\text{ V}$	25°C	$R_L = 600\ \Omega$ ‡		1	1.5	1	1.5	V/mV
			Full range		0.3				
		25°C	$R_L = 1\text{ M}\Omega$ ‡		400			400	
r_{id} Differential input resistance		25°C	10^{12}			10^{12}			Ω
r_{ic} Common-mode input resistance		25°C	10^{12}			10^{12}			Ω
c_{ic} Common-mode input capacitance	$f = 10\text{ kHz}$	25°C	6			6			pF
z_o Closed-loop output impedance	$f = 1\text{ MHz}$, $A_V = 1$	25°C	138			138			Ω
CMRR Common-mode rejection ratio	$V_{IC} = 0\text{ to }2.7\text{ V}$, $V_O = 2.5\text{ V}$, $R_S = 50\ \Omega$	25°C	60	70		60	70		dB
		Full range	55			55			
k_{SVR} Supply voltage rejection ratio ($\Delta V_{DD} / \Delta V_{IO}$)	$V_{DD} = 4.4\text{ V to }8\text{ V}$, $V_{IC} = V_{DD}/2$, No load	25°C	70	96		70	96		dB
		Full range	70			70			
I_{DD} Supply current	$V_O = 2.5\text{ V}$, No load	25°C	850	1300		850	1300		μA
		Full range	1600			1600			

† Full range for the TLV2231C is 0°C to 70°C. Full range for the TLV2231I is -40°C to 85°C.

‡ Referenced to 2.5 V

NOTE 5: Typical values are based on the input offset voltage shift observed through 500 hours of operating life test at $T_A = 150^\circ\text{C}$ extrapolated to $T_A = 25^\circ\text{C}$ using the Arrhenius equation and assuming an activation energy of 0.96 eV.



TLV2231, TLV2231Y
Advanced LinCMOS™ RAIL-TO-RAIL
LOW-POWER SINGLE OPERATIONAL AMPLIFIERS

SLOS158D – JUNE 1996 – REVISED APRIL 2001

operating characteristics at specified free-air temperature, $V_{DD} = 5\text{ V}$

PARAMETER	TEST CONDITIONS	T_A †	TLV2231C			TLV2231I			UNIT
			MIN	TYP	MAX	MIN	TYP	MAX	
SR	Slew rate at unity gain $V_O = 1.5\text{ V to }3.5\text{ V}, R_L = 600\ \Omega\ddagger, C_L = 100\text{ pF}\ddagger$	25°C	1	1.6		1	1.6		V/ μs
		Full range	0.7			0.7			
V_n	Equivalent input noise voltage $f = 10\text{ Hz}$ $f = 1\text{ kHz}$	25°C		100			100		nV/ $\sqrt{\text{Hz}}$
		25°C		15			15		
$V_{N(PP)}$	Peak-to-peak equivalent input noise voltage $f = 0.1\text{ Hz to }1\text{ Hz}$ $f = 0.1\text{ Hz to }10\text{ Hz}$	25°C		1.4			1.4		μV
		25°C		1.5			1.5		
I_n	Equivalent input noise current	25°C		0.6			0.6		fA/ $\sqrt{\text{Hz}}$
THD+N	Total harmonic distortion plus noise $V_O = 1.5\text{ V to }3.5\text{ V}, f = 20\text{ kHz}, R_L = 600\ \Omega\ddagger$ $V_O = 1.5\text{ V to }3.5\text{ V}, f = 20\text{ kHz}, R_L = 600\ \Omega\text{\S}$	25°C		$A_V = 1$		0.409%		0.409%	
				$A_V = 10$		3.68%		3.68%	
		25°C		$A_V = 1$		0.018%		0.018%	
				$A_V = 10$		0.045%		0.045%	
				$A_V = 100$		0.116%		0.116%	
		Gain-bandwidth product	$f = 10\text{ kHz}, R_L = 600\ \Omega\ddagger, C_L = 100\text{ pF}\ddagger$	25°C		2		2	
B_{OM}	Maximum output-swing bandwidth $V_{O(PP)} = 1\text{ V}, R_L = 600\ \Omega\ddagger, A_V = 1, C_L = 100\text{ pF}\ddagger$	25°C		300		300		kHz	
t_s	Settling time $A_V = -1, \text{ Step} = 1.5\text{ V to }3.5\text{ V}, R_L = 600\ \Omega\ddagger, C_L = 100\text{ pF}\ddagger$	25°C		To 0.1%		0.95		0.95	μs
				To 0.01%		2.4		2.4	
ϕ_m	Phase margin at unity gain $R_L = 600\ \Omega\ddagger, C_L = 100\text{ pF}\ddagger$	25°C		48°		48°			
		25°C		8		8		dB	
	Gain margin	25°C		8		8		dB	

† Full range is -40°C to 85°C .

‡ Referenced to 2.5 V

§ Referenced to 0 V



TLV2231, TLV2231Y
Advanced LinCMOS™ RAIL-TO-RAIL
LOW-POWER SINGLE OPERATIONAL AMPLIFIERS

SLOS158D – JUNE 1996 – REVISED APRIL 2001

electrical characteristics at $V_{DD} = 3\text{ V}$, $T_A = 25^\circ\text{C}$ (unless otherwise noted)

PARAMETER	TEST CONDITIONS	TLV2231Y			UNIT
		MIN	TYP	MAX	
V_{IO} Input offset voltage	$V_{DD} \pm \pm 1.5\text{ V}$, $R_S = 50\ \Omega$	$V_{IC} = 0$,	$V_O = 0$,	750	μV
I_{IO} Input offset current				0.5	pA
I_{IB} Input bias current				1	pA
V_{ICR} Common-mode input voltage range	$ V_{IO} \leq 5\text{ mV}$,	$R_S = 50\ \Omega$		-0.3 to 2.2	V
V_{OH} High-level output voltage	$I_{OH} = -1\text{ mA}$			2.87	V
V_{OL} Low-level output voltage	$V_{IC} = 1.5\text{ V}$,	$I_{OL} = 50\ \mu\text{A}$		10	mV
	$V_{IC} = 1.5\text{ V}$,	$I_{OL} = 500\ \mu\text{A}$		100	
A_{VD} Large-signal differential voltage amplification	$V_O = 1\text{ V to }2\text{ V}$		$R_L = 600\ \Omega^\dagger$	1.6	V/mV
			$R_L = 1\text{ M}\Omega^\dagger$	250	
r_{id} Differential input resistance				10^{12}	Ω
r_{ic} Common-mode input resistance				10^{12}	Ω
C_{ic} Common-mode input capacitance	$f = 10\text{ kHz}$			6	pF
Z_o Closed-loop output impedance	$f = 1\text{ MHz}$,	$A_V = 1$		156	Ω
CMRR Common-mode rejection ratio	$V_{IC} = 0\text{ to }1.7\text{ V}$,	$V_O = 0$,	$R_S = 50\ \Omega$	60 70	dB
k_{SVR} Supply voltage rejection ratio ($\Delta V_{DD}/\Delta V_{IO}$)	$V_{DD} = 2.7\text{ V to }8\text{ V}$,	$V_{IC} = 0$,	No load	96	dB
I_{DD} Supply current	$V_O = 0$,	No load		750	μA

† Referenced to 1.5 V

electrical characteristics at $V_{DD} = 5\text{ V}$, $T_A = 25^\circ\text{C}$ (unless otherwise noted)

PARAMETER	TEST CONDITIONS	TLV2231Y			UNIT
		MIN	TYP	MAX	
V_{IO} Input offset voltage	$V_{DD} \pm \pm 1.5\text{ V}$, $R_S = 50\ \Omega$	$V_{IC} = 0$,	$V_O = 0$,	710	μV
I_{IO} Input offset current				0.5	pA
I_{IB} Input bias current				1	pA
V_{ICR} Common-mode input voltage range	$ V_{IO} \leq 5\text{ mV}$,	$R_S = 50\ \Omega$		-0.3 to 4.2	V
V_{OH} High-level output voltage	$I_{OH} = -1\text{ mA}$			4.9	V
V_{OL} Low-level output voltage	$V_{IC} = 2.5\text{ V}$,	$I_{OL} = 500\ \mu\text{A}$		80	mV
	$V_{IC} = 2.5\text{ V}$,	$I_{OL} = 1\text{ mA}$		160	
A_{VD} Large-signal differential voltage amplification	$V_O = 1\text{ V to }2\text{ V}$		$R_L = 600\ \Omega^\dagger$	15	V/mV
			$R_L = 1\text{ M}\Omega^\dagger$	400	
r_{id} Differential input resistance				10^{12}	Ω
r_{ic} Common-mode input resistance				10^{12}	Ω
C_{ic} Common-mode input capacitance	$f = 10\text{ kHz}$			6	pF
Z_o Closed-loop output impedance	$f = 1\text{ MHz}$,	$A_V = 1$		138	Ω
CMRR Common-mode rejection ratio	$V_{IC} = 0\text{ to }1.7\text{ V}$,	$V_O = 0$,	$R_S = 50\ \Omega$	60 70	dB
k_{SVR} Supply voltage rejection ratio ($\Delta V_{DD}/\Delta V_{IO}$)	$V_{DD} = 2.7\text{ V to }8\text{ V}$,	$V_{IC} = 0$,	No load	96	dB
I_{DD} Supply current	$V_O = 0$,	No load		850	μA

† Referenced to 2.5 V



TYPICAL CHARACTERISTICS

Table of Graphs

		FIGURE
V_{IO}	Input offset voltage	Distribution vs Common-mode input voltage 2, 3 4, 5
α_{VIO}	Input offset voltage temperature coefficient	Distribution 6, 7
I_{IB}/I_{IO}	Input bias and input offset currents	vs Free-air temperature 8
V_I	Input voltage	vs Supply voltage vs Free-air temperature 9 10
V_{OH}	High-level output voltage	vs High-level output current 11, 14
V_{OL}	Low-level output voltage	vs Low-level output current 12, 13, 15
$V_{O(PP)}$	Maximum peak-to-peak output voltage	vs Frequency 16
I_{OS}	Short-circuit output current	vs Supply voltage vs Free-air temperature 17 18
V_O	Output voltage	vs Differential input voltage 19, 20
A_{VD}	Differential voltage amplification	vs Load resistance 21
A_{VD}	Large-signal differential voltage amplification	vs Frequency vs Free-air temperature 22, 23 24, 25
z_o	Output impedance	vs Frequency 26, 27
$CMRR$	Common-mode rejection ratio	vs Frequency vs Free-air temperature 28 29
k_{SVR}	Supply-voltage rejection ratio	vs Frequency vs Free-air temperature 30, 31 32
I_{DD}	Supply current	vs Supply voltage 33
SR	Slew rate	vs Load capacitance vs Free-air temperature 34 35
V_O	Inverting large-signal pulse response	vs Time 36, 37
V_O	Voltage-follower large-signal pulse response	vs Time 38, 39
V_O	Inverting small-signal pulse response	vs Time 40, 41
V_O	Voltage-follower small-signal pulse response	vs Time 42, 43
V_n	Equivalent input noise voltage	vs Frequency 44, 45
	Noise voltage (referred to input)	Over a 10-second period 46
$THD + N$	Total harmonic distortion plus noise	vs Frequency 47
	Gain-bandwidth product	vs Free-air temperature vs Supply voltage 48 49
	Gain margin	vs Load capacitance 50, 51
ϕ_m	Phase margin	vs Frequency vs Load capacitance 22, 23 52, 53
B_1	Unity-gain bandwidth	vs Load capacitance 54, 55

TYPICAL CHARACTERISTICS

**DISTRIBUTION OF TLV2231
INPUT OFFSET VOLTAGE**

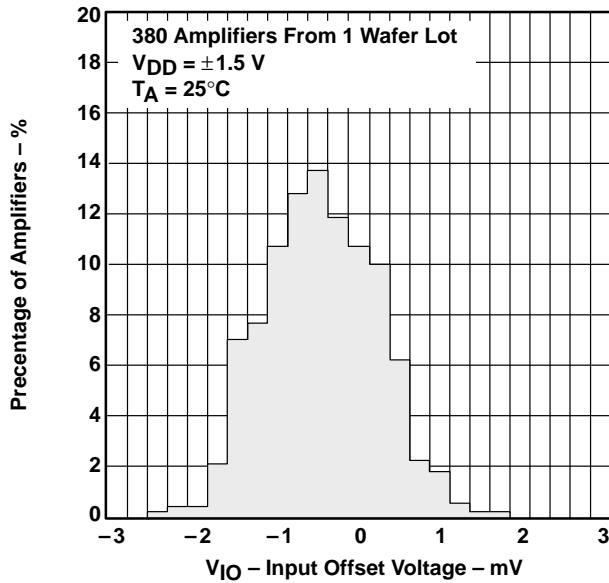

Figure 2

**DISTRIBUTION OF TLV2231
INPUT OFFSET VOLTAGE**

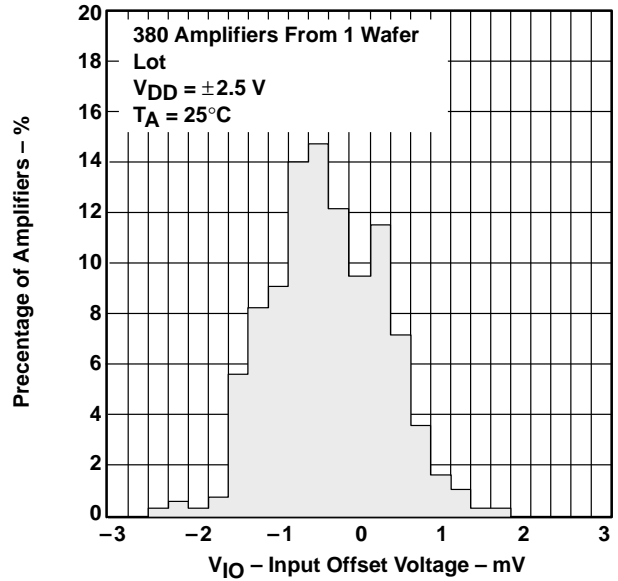

Figure 3

**INPUT OFFSET VOLTAGE†
vs
COMMON-MODE INPUT VOLTAGE**

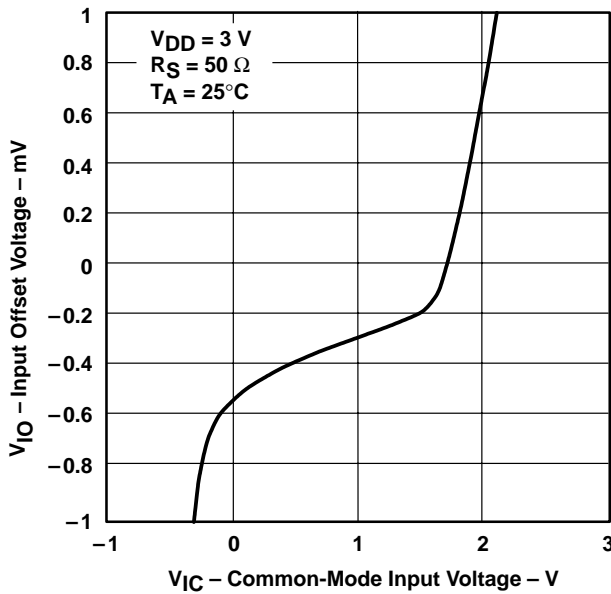

Figure 4

**INPUT OFFSET VOLTAGE†
vs
COMMON-MODE INPUT VOLTAGE**

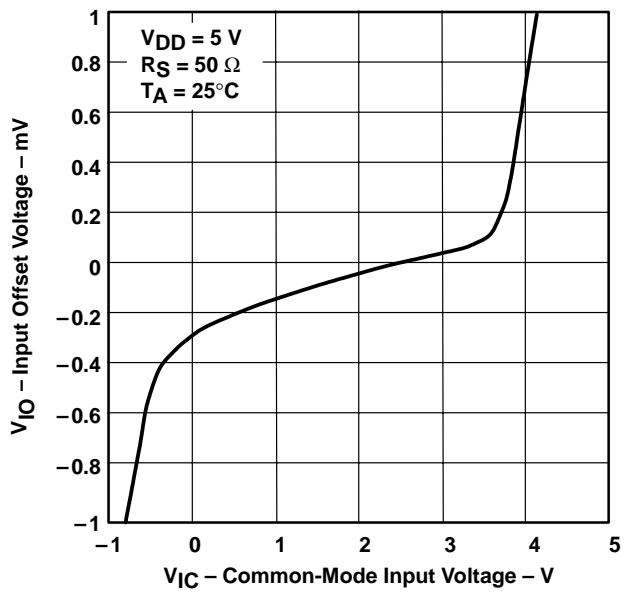

Figure 5

† For all curves where $V_{DD} = 5 \text{ V}$, all loads are referenced to 2.5 V. For all curves where $V_{DD} = 3 \text{ V}$, all loads are referenced to 1.5 V.

TYPICAL CHARACTERISTICS

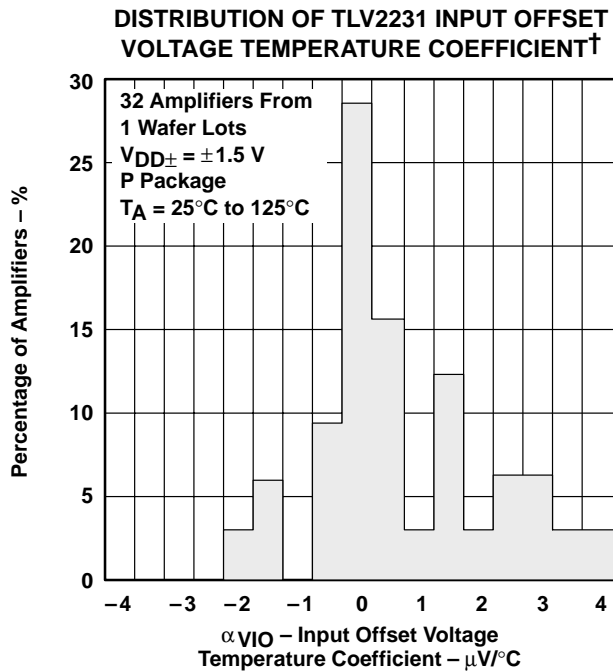

Figure 6

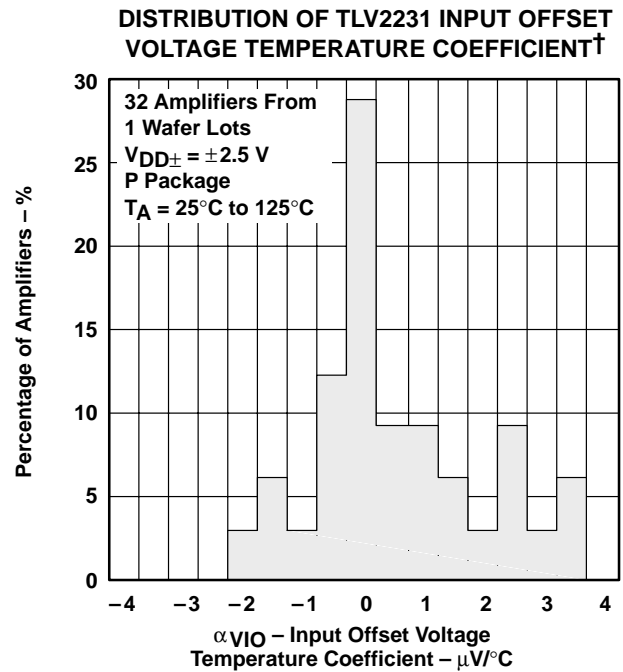

Figure 7

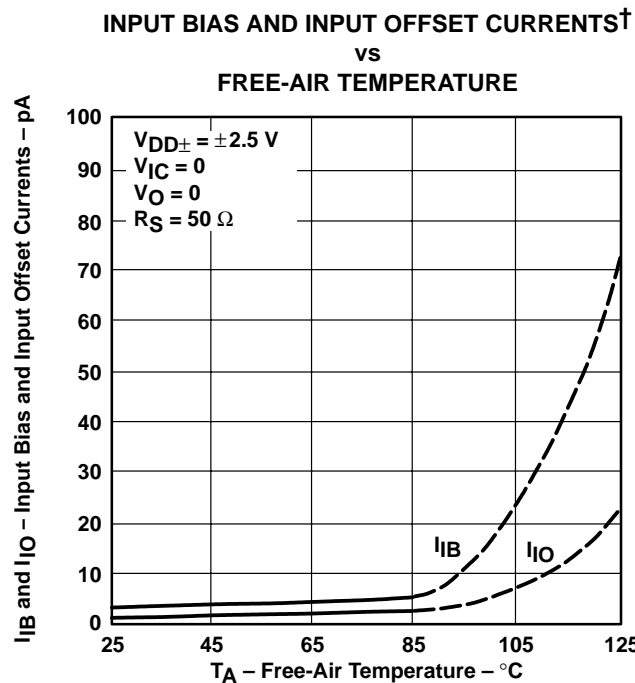

Figure 8

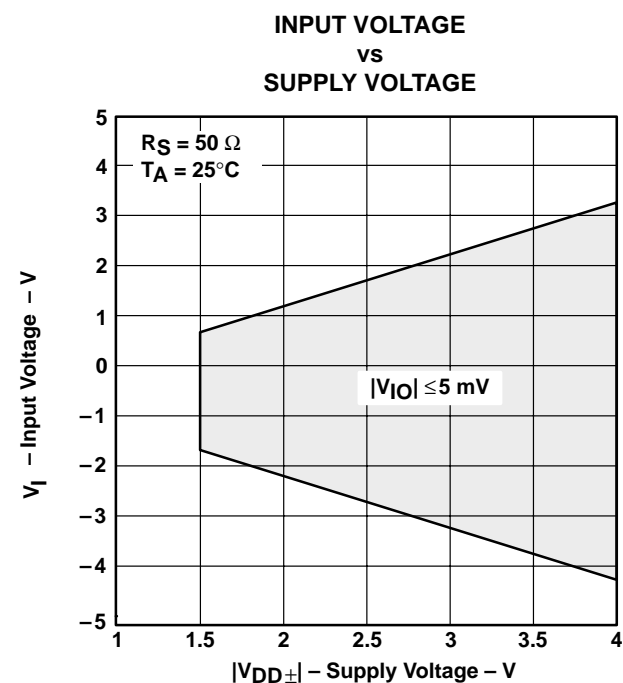

Figure 9

† Data at high and low temperatures are applicable only within the rated operating free-air temperature ranges of the various devices.

TYPICAL CHARACTERISTICS

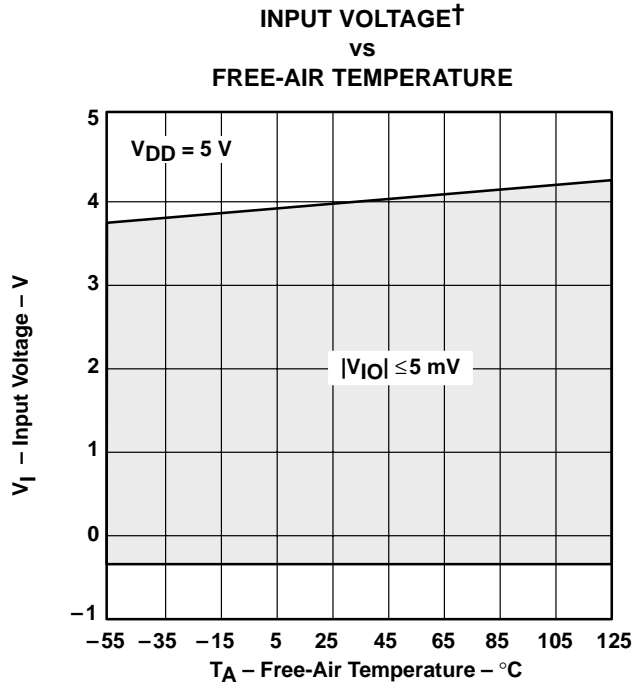

Figure 10

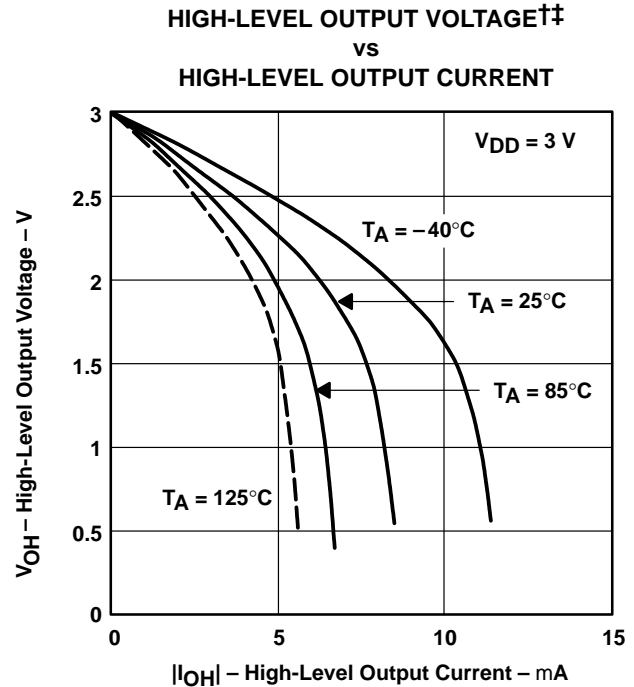

Figure 11

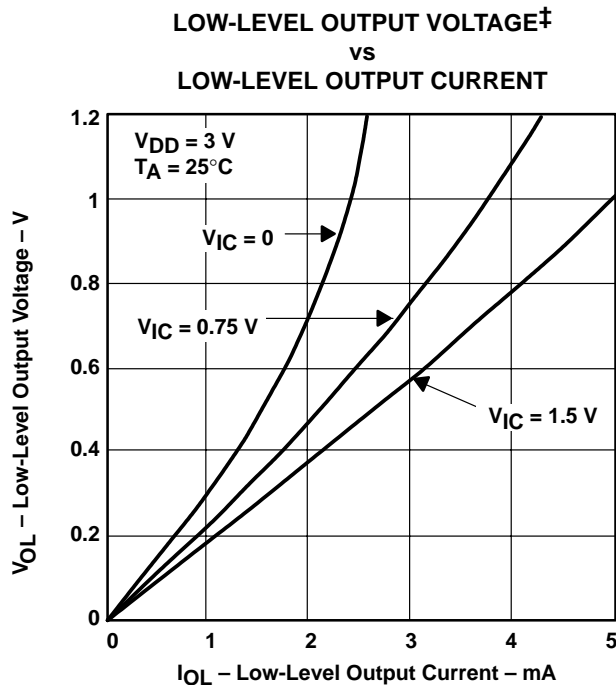

Figure 12

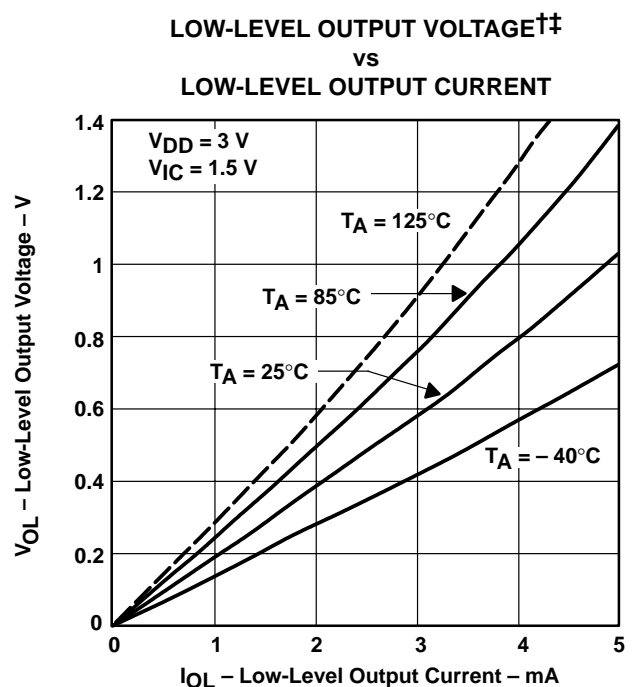

Figure 13

† Data at high and low temperatures are applicable only within the rated operating free-air temperature ranges of the various devices.

‡ For all curves where $V_{DD} = 5\text{ V}$, all loads are referenced to 2.5 V. For all curves where $V_{DD} = 3\text{ V}$, all loads are referenced to 1.5 V.

TYPICAL CHARACTERISTICS

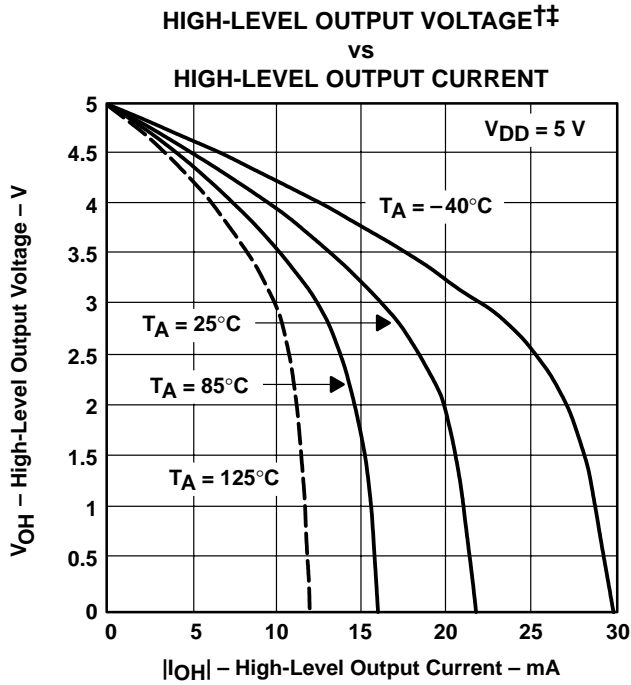

Figure 14

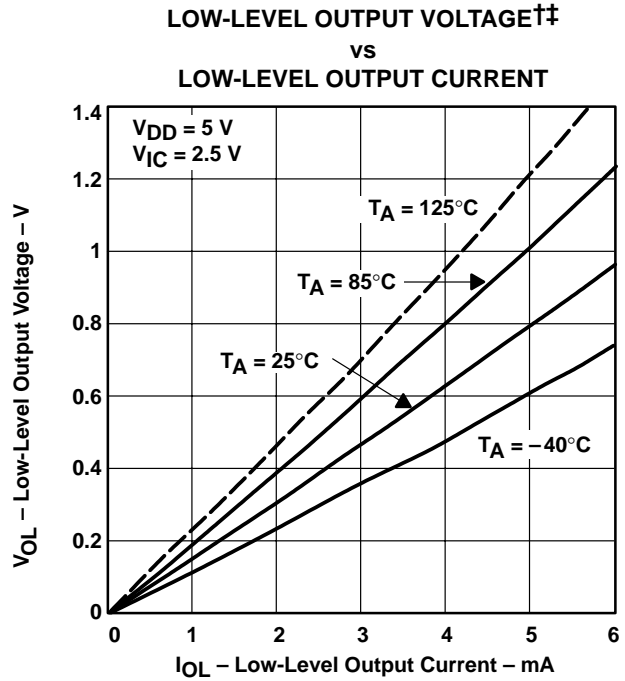

Figure 15

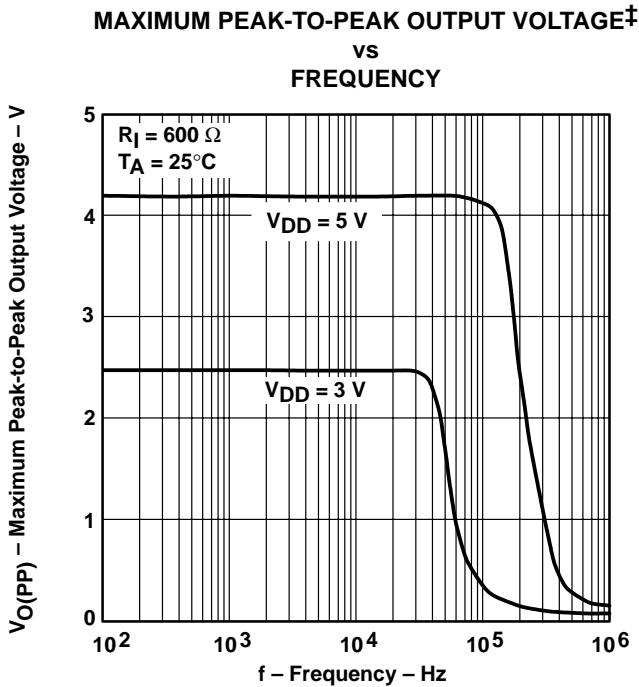

Figure 16

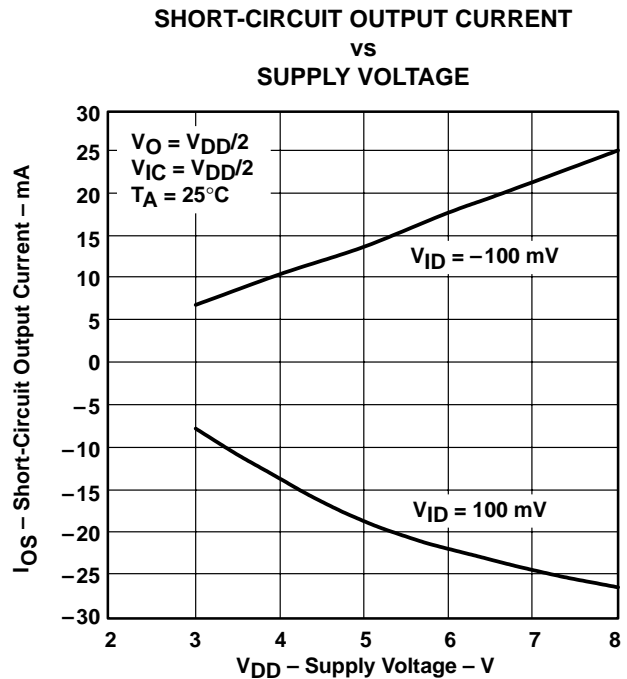
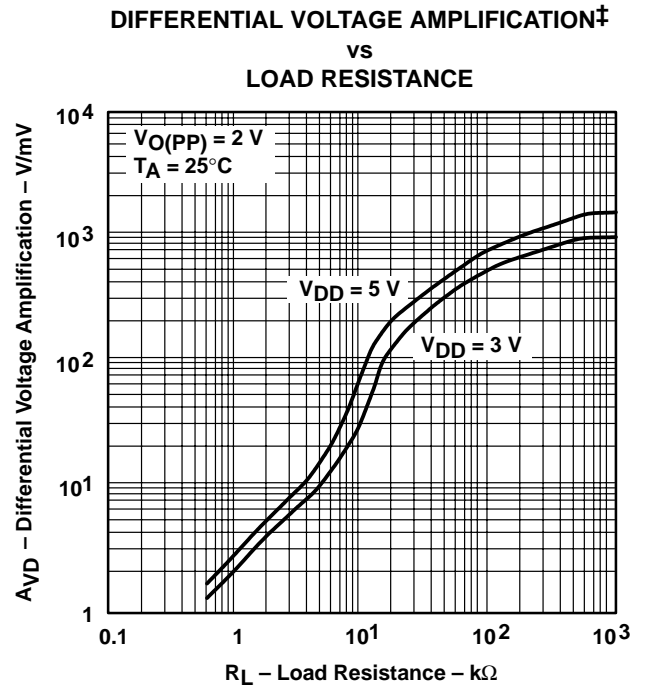
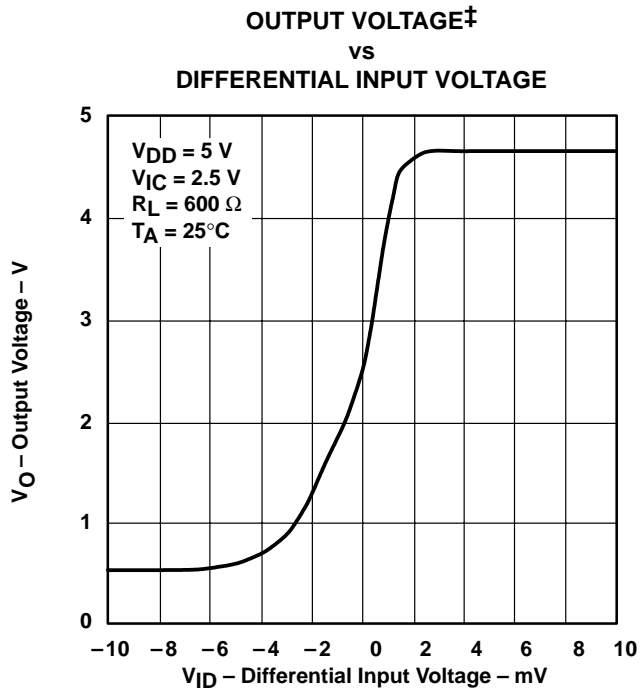
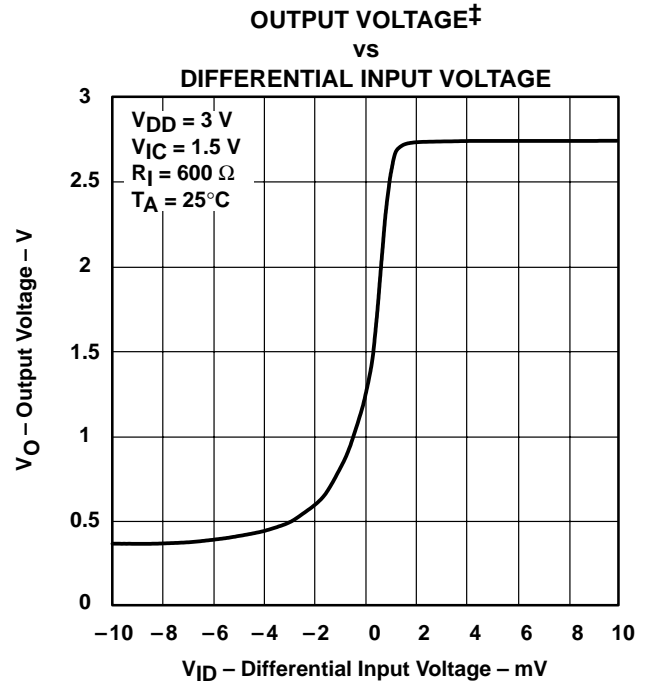
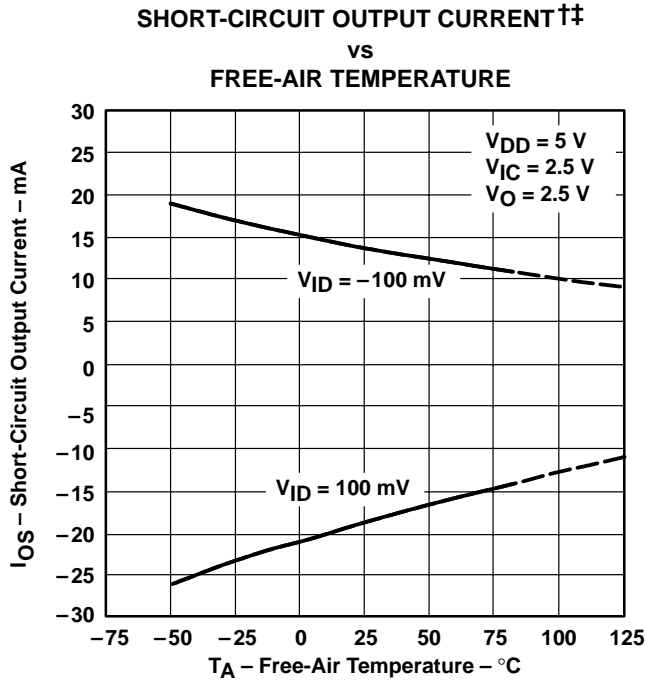

Figure 17

† Data at high and low temperatures are applicable only within the rated operating free-air temperature ranges of the various devices.
 ‡ For all curves where $V_{DD} = 5\text{ V}$, all loads are referenced to 2.5 V. For all curves where $V_{DD} = 3\text{ V}$, all loads are referenced to 1.5 V.

TYPICAL CHARACTERISTICS



† Data at high and low temperatures are applicable only within the rated operating free-air temperature ranges of the various devices.
 †† For all curves where $V_{DD} = 5\text{ V}$, all loads are referenced to 2.5 V. For all curves where $V_{DD} = 3\text{ V}$, all loads are referenced to 1.5 V.

TYPICAL CHARACTERISTICS

LARGE-SIGNAL DIFFERENTIAL VOLTAGE
 AMPLIFICATION AND PHASE MARGIN†

vs
 FREQUENCY

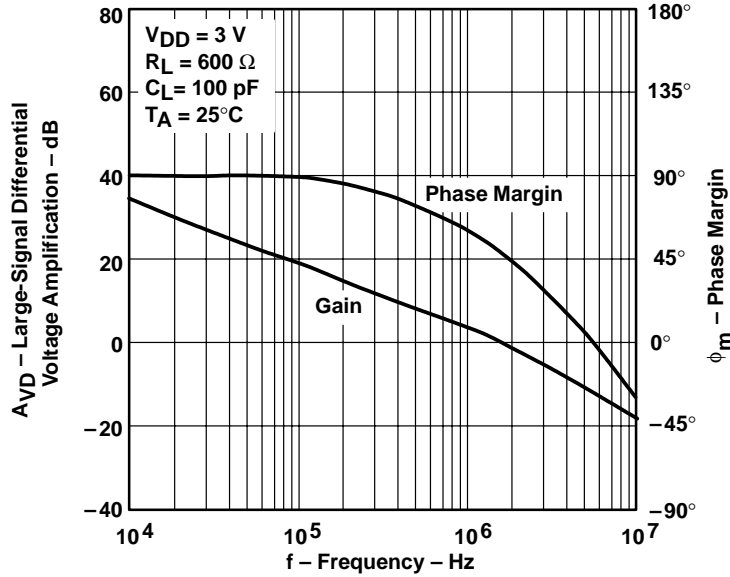

Figure 22

LARGE-SIGNAL DIFFERENTIAL VOLTAGE
 AMPLIFICATION AND PHASE MARGIN†

vs
 FREQUENCY

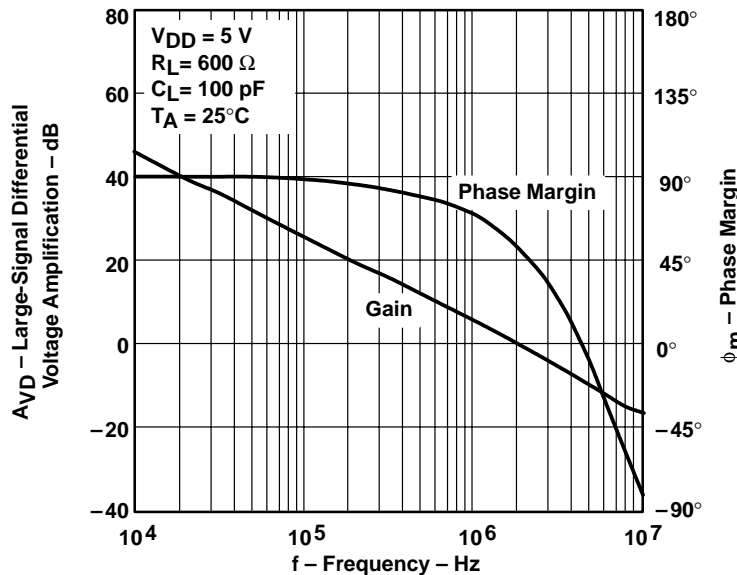
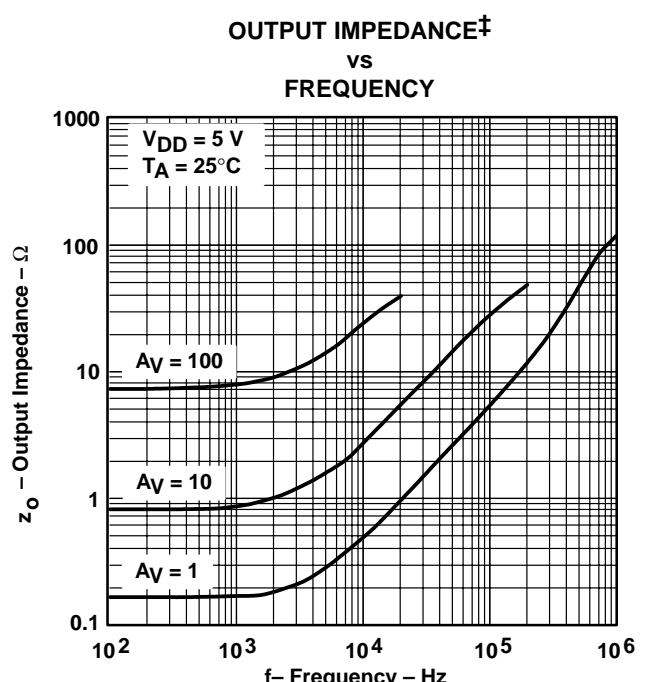
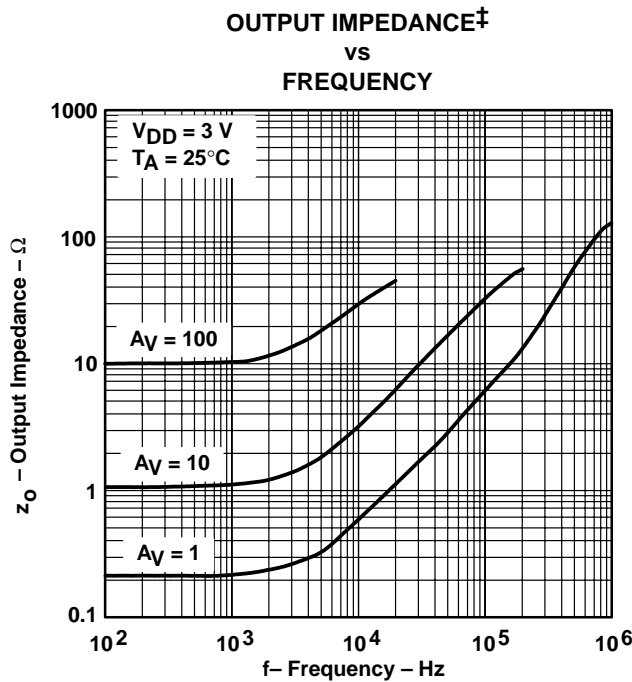
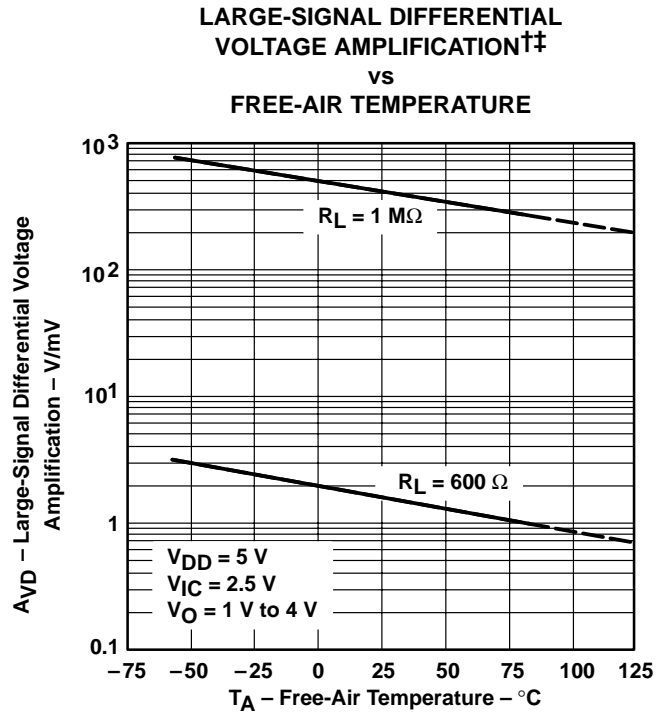
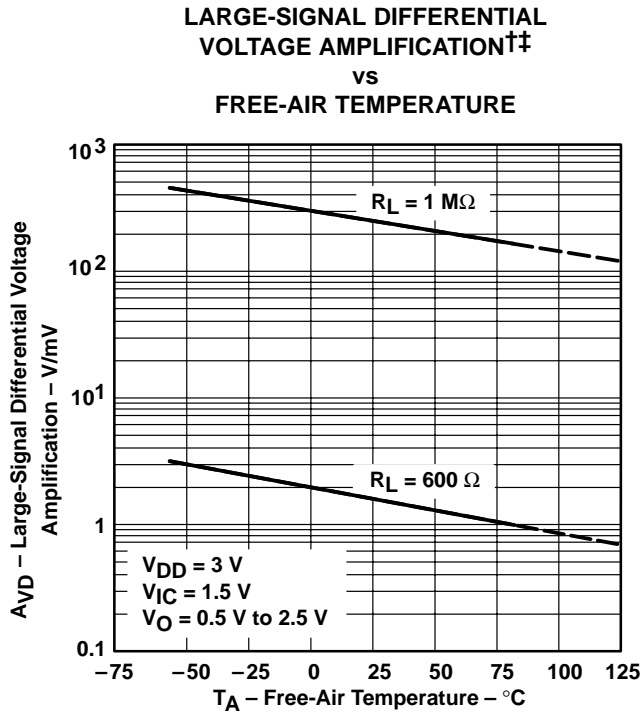

Figure 23

† For all curves where $V_{DD} = 5\text{ V}$, all loads are referenced to 2.5 V. For all curves where $V_{DD} = 3\text{ V}$, all loads are referenced to 1.5 V.

TYPICAL CHARACTERISTICS



† Data at high and low temperatures are applicable only within the rated operating free-air temperature ranges of the various devices.
 ‡ For all curves where $V_{DD} = 5\text{ V}$, all loads are referenced to 2.5 V. For all curves where $V_{DD} = 3\text{ V}$, all loads are referenced to 1.5 V.

TYPICAL CHARACTERISTICS

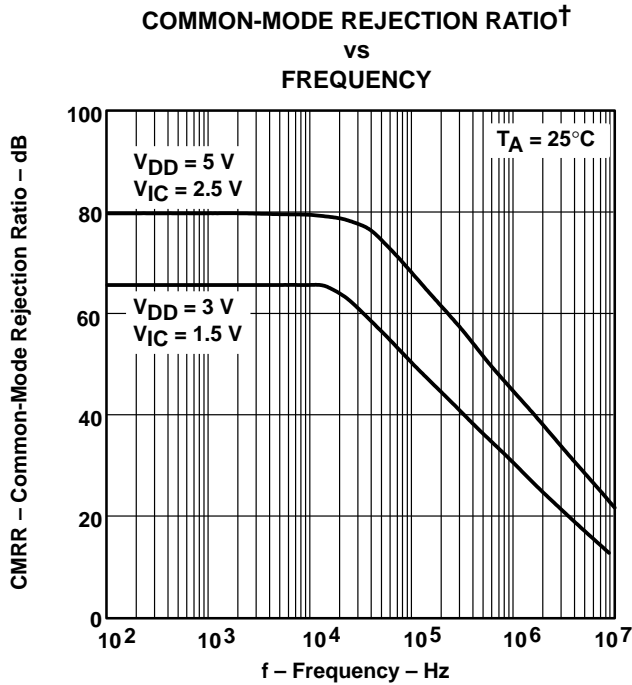

Figure 28

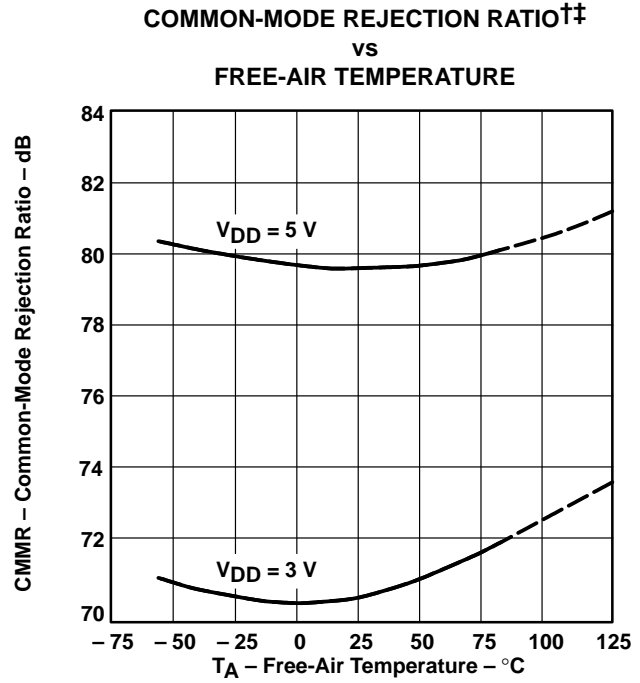

Figure 29

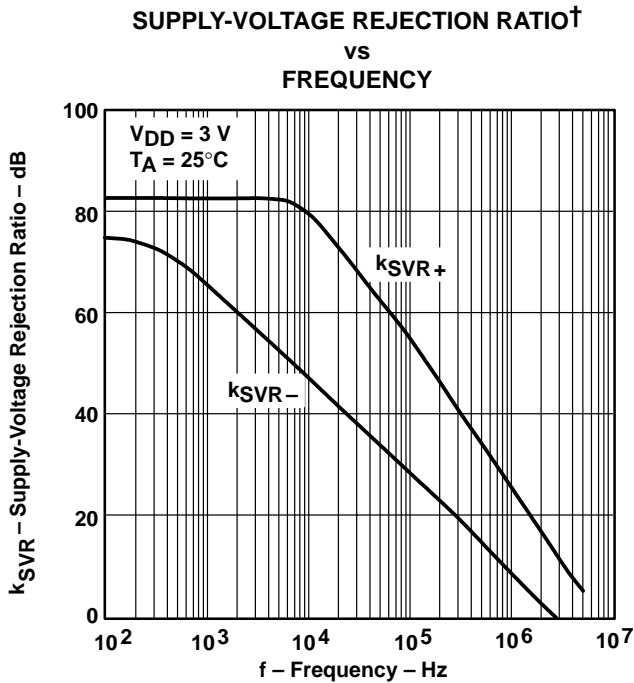

Figure 30

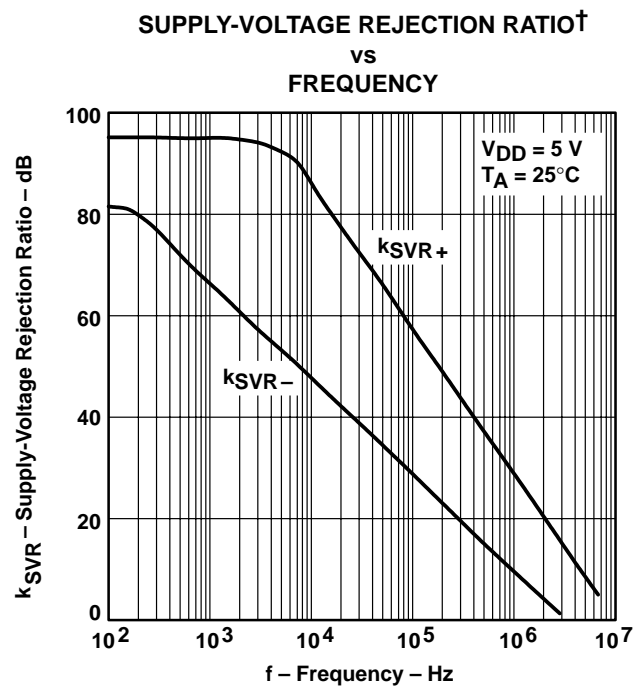
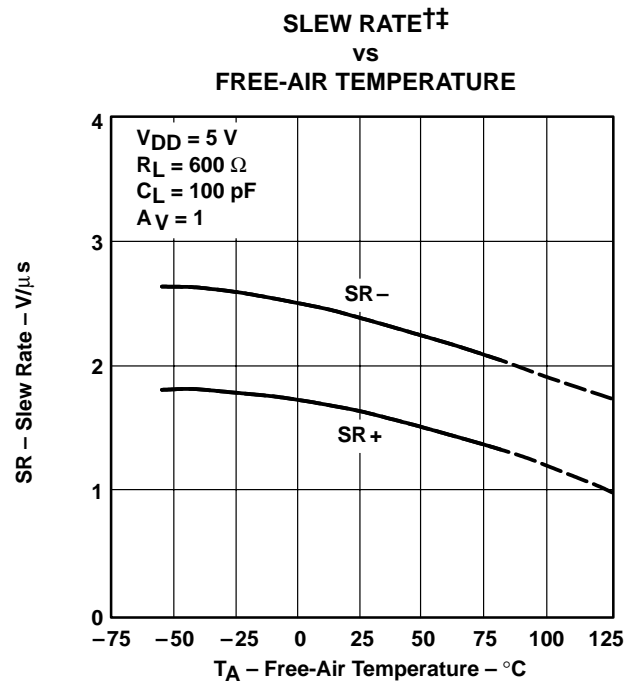
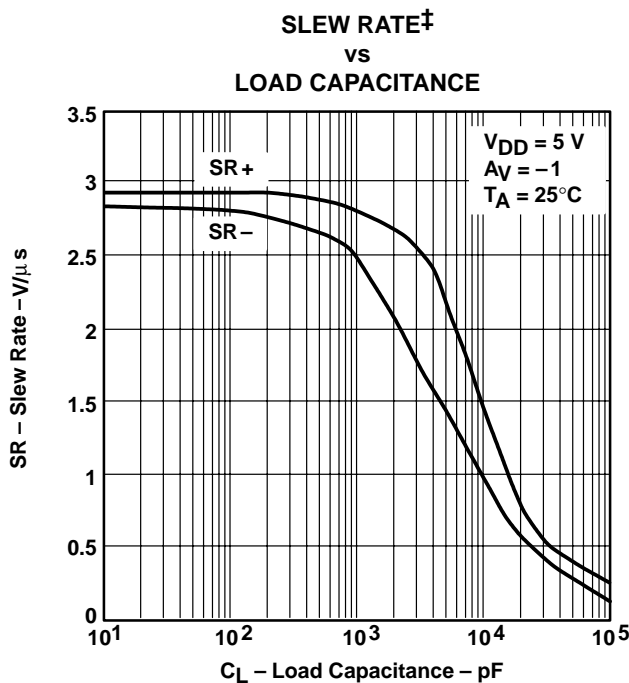
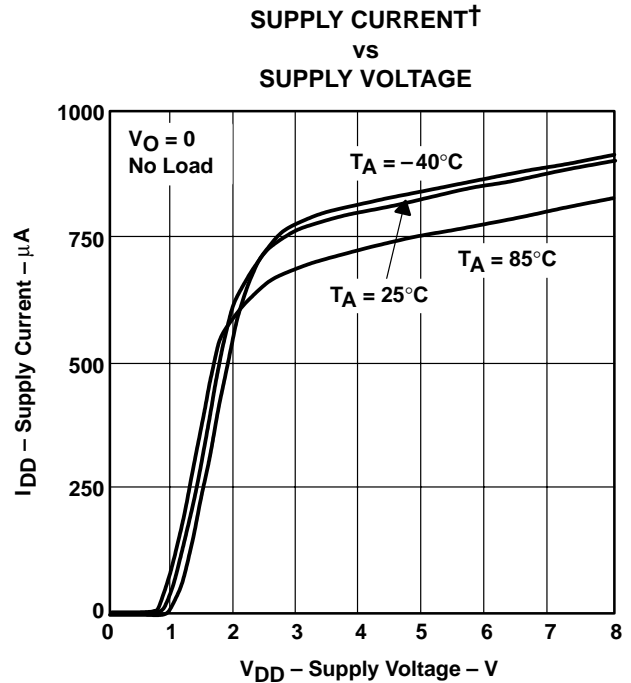
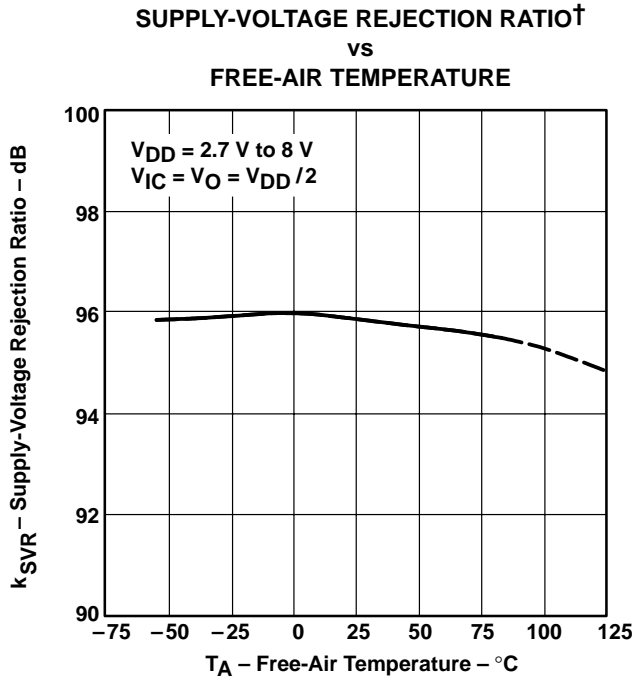

Figure 31

† For all curves where $V_{DD} = 5\text{ V}$, all loads are referenced to 2.5 V. For all curves where $V_{DD} = 3\text{ V}$, all loads are referenced to 1.5 V.
 ‡ Data at high and low temperatures are applicable only within the rated operating free-air temperature ranges of the various devices.

TYPICAL CHARACTERISTICS



† Data at high and low temperatures are applicable only within the rated operating free-air temperature ranges of the various devices.
 ‡ For all curves where $V_{DD} = 5\text{ V}$, all loads are referenced to 2.5 V. For all curves where $V_{DD} = 3\text{ V}$, all loads are referenced to 1.5 V.

TYPICAL CHARACTERISTICS

INVERTING LARGE-SIGNAL PULSE RESPONSE†

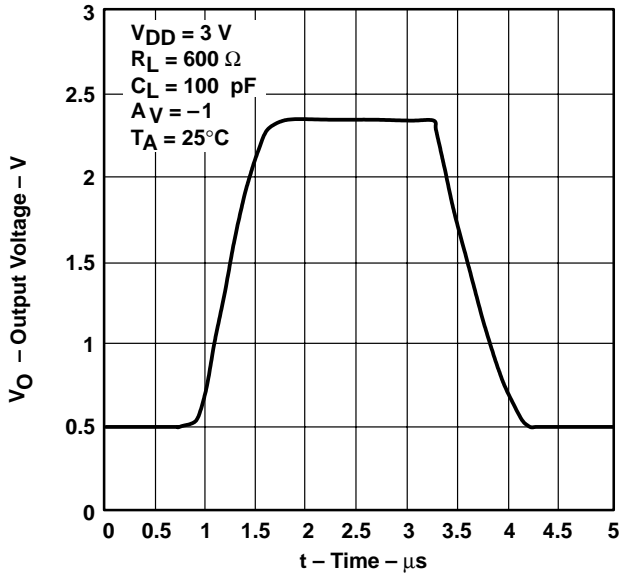

Figure 36

INVERTING LARGE-SIGNAL PULSE RESPONSE†

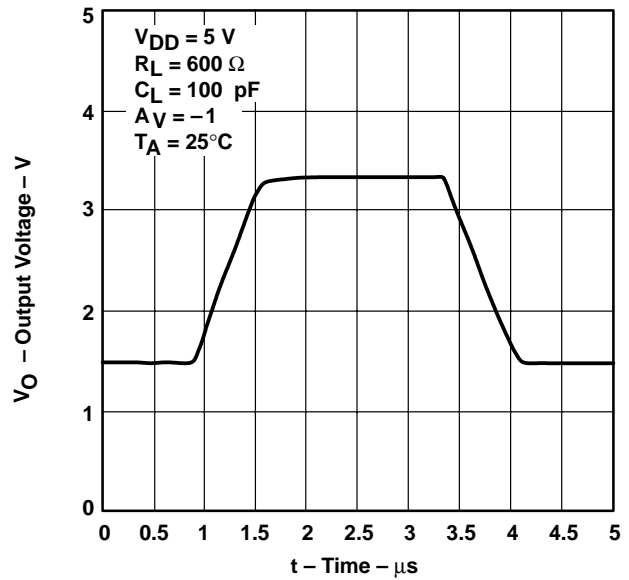

Figure 37

VOLTAGE-FOLLOWER LARGE-SIGNAL PULSE RESPONSE†

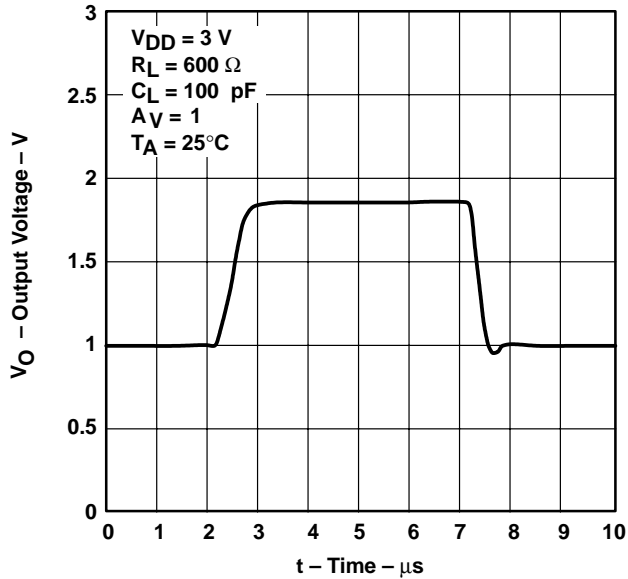

Figure 38

VOLTAGE-FOLLOWER LARGE-SIGNAL PULSE RESPONSE†

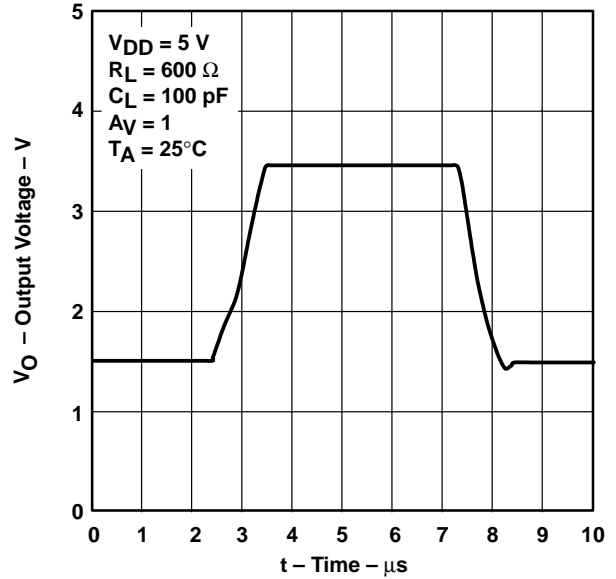

Figure 39

† For all curves where $V_{DD} = 5\text{ V}$, all loads are referenced to 2.5 V. For all curves where $V_{DD} = 3\text{ V}$, all loads are referenced to 1.5 V.

TYPICAL CHARACTERISTICS

INVERTING SMALL-SIGNAL PULSE RESPONSE†

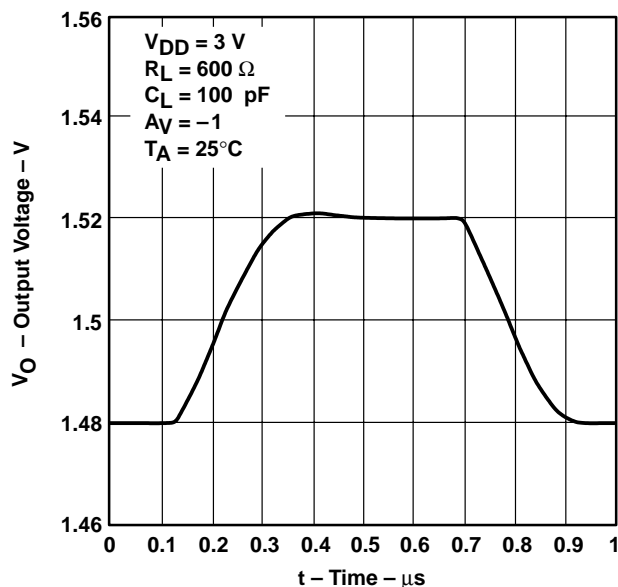

Figure 40

INVERTING SMALL-SIGNAL PULSE RESPONSE†

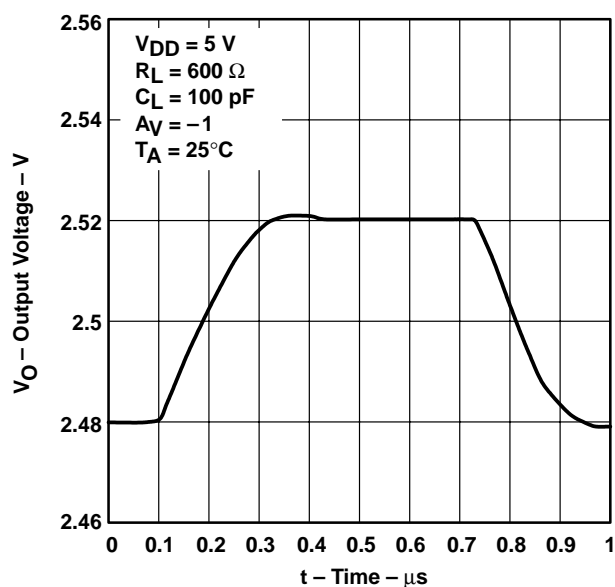

Figure 41

VOLTAGE-FOLLOWER SMALL-SIGNAL PULSE RESPONSE†

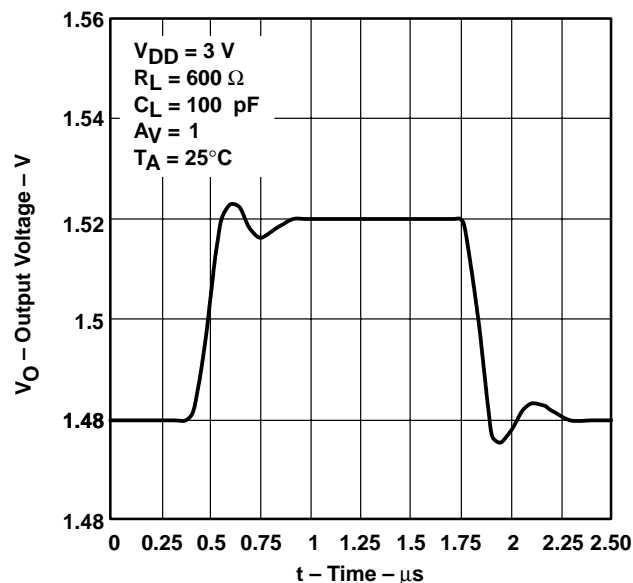

Figure 42

VOLTAGE-FOLLOWER SMALL-SIGNAL PULSE RESPONSE†

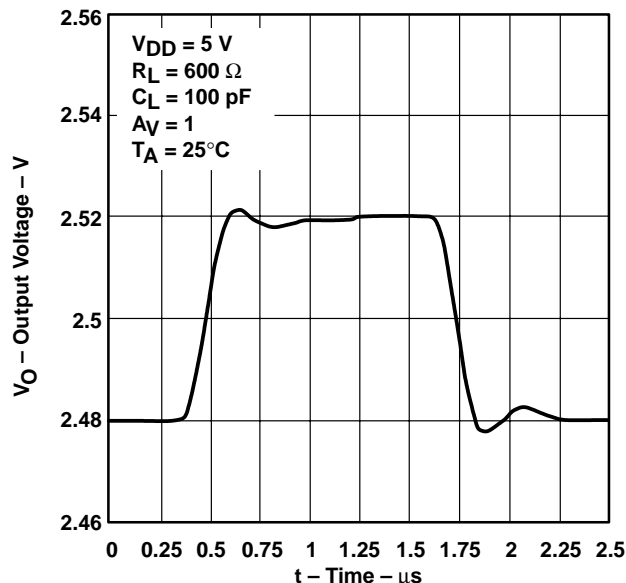

Figure 43

† For all curves where $V_{DD} = 5\text{ V}$, all loads are referenced to 2.5 V. For all curves where $V_{DD} = 3\text{ V}$, all loads are referenced to 1.5 V.

TYPICAL CHARACTERISTICS

EQUIVALENT INPUT NOISE VOLTAGE†
 VS
 FREQUENCY

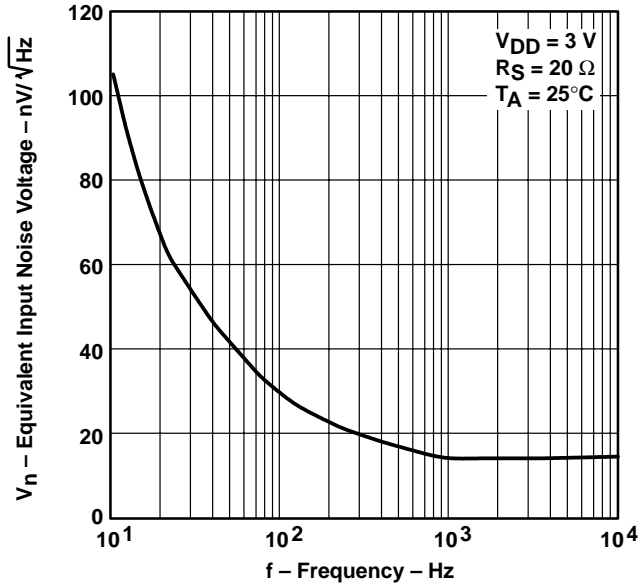

Figure 44

EQUIVALENT INPUT NOISE VOLTAGE†
 VS
 FREQUENCY

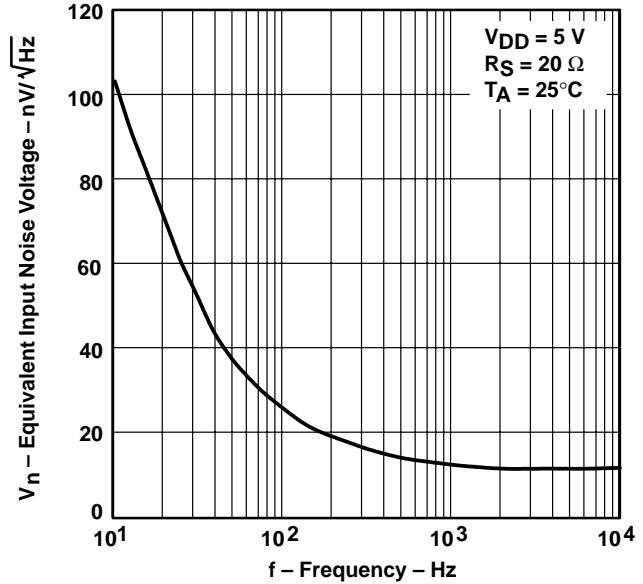

Figure 45

INPUT NOISE VOLTAGE OVER
 A 10-SECOND PERIOD†

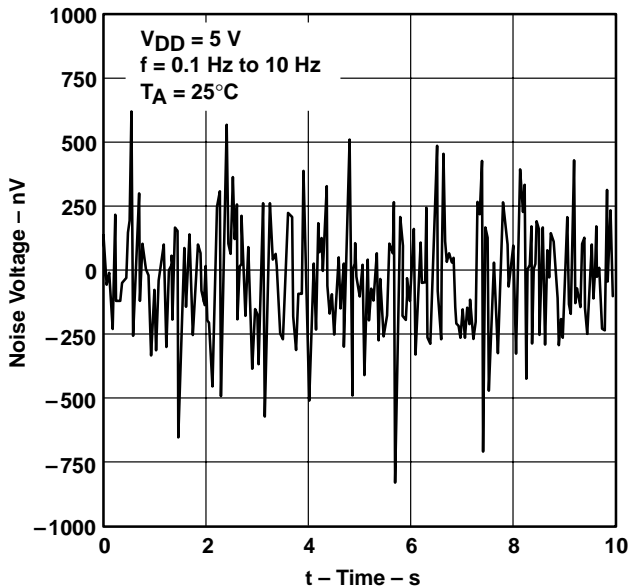

Figure 46

TOTAL HARMONIC DISTORTION PLUS NOISE†
 VS
 FREQUENCY

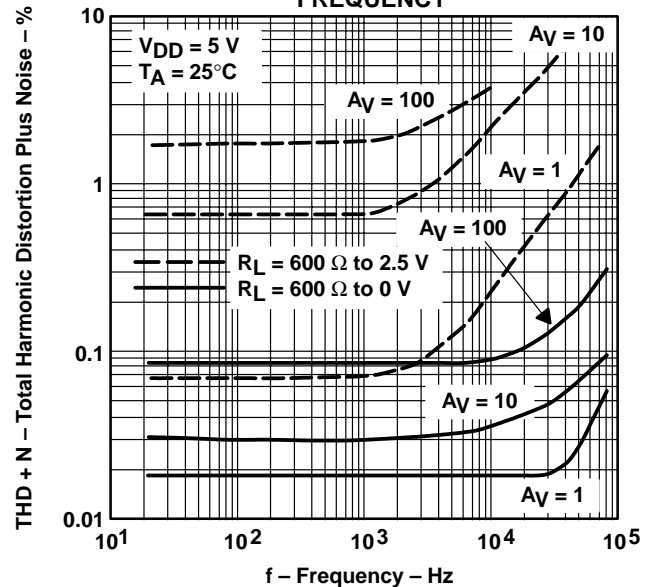
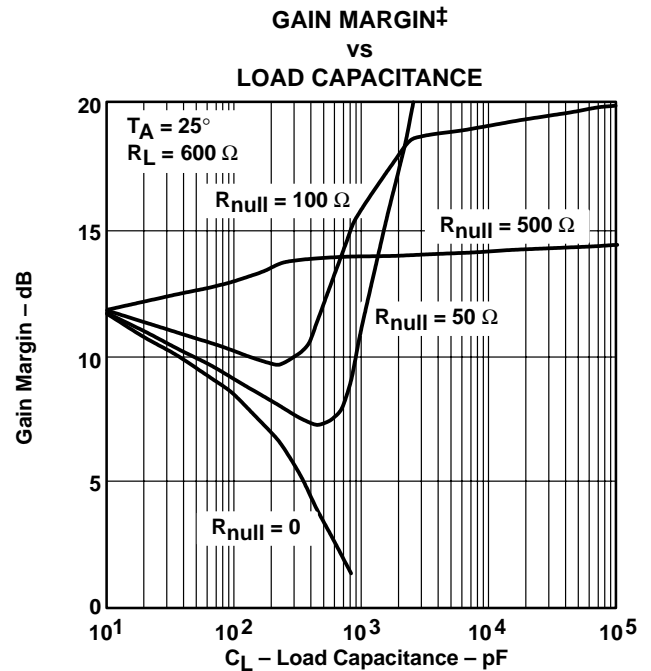
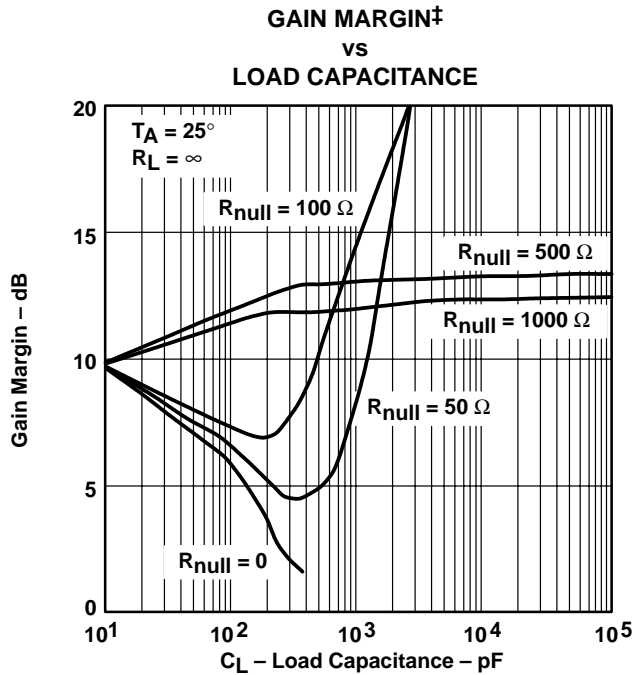
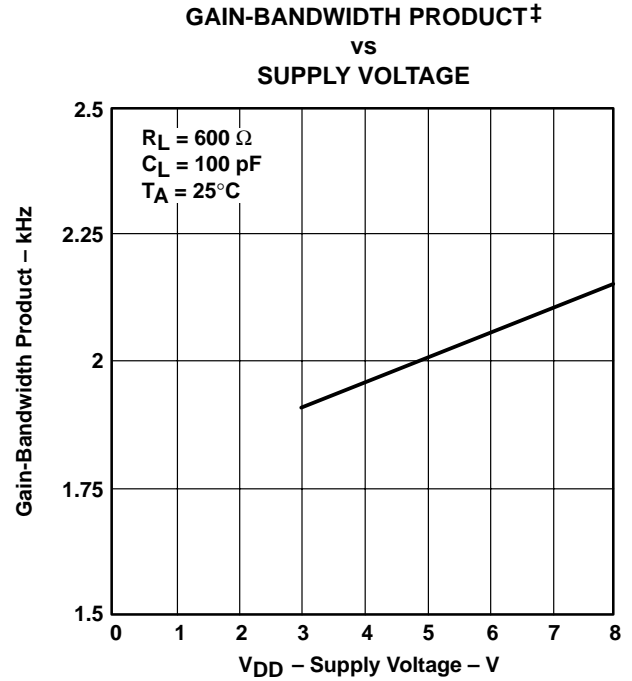
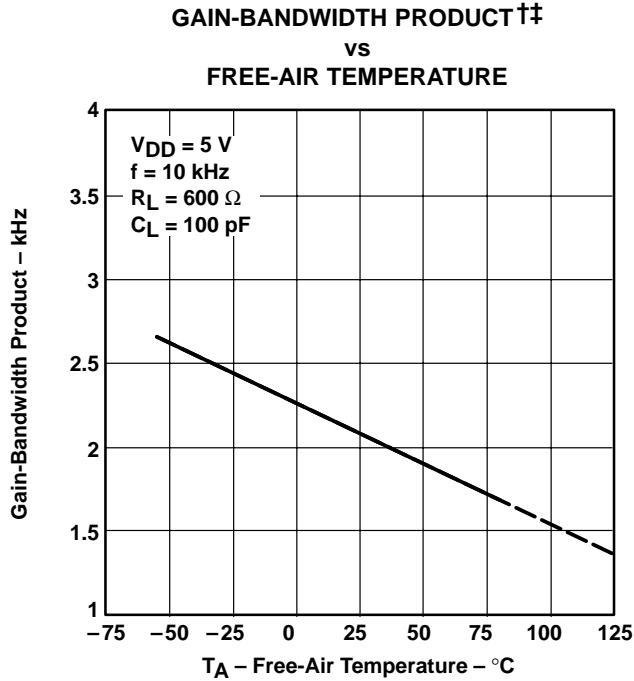

Figure 47

† For all curves where $V_{DD} = 5\text{ V}$, all loads are referenced to 2.5 V. For all curves where $V_{DD} = 3\text{ V}$, all loads are referenced to 1.5 V.

TYPICAL CHARACTERISTICS



† Data at high and low temperatures are applicable only within the rated operating free-air temperature ranges of the various devices.
 ‡ For all curves where $V_{DD} = 5\text{ V}$, all loads are referenced to 2.5 V. For all curves where $V_{DD} = 3\text{ V}$, all loads are referenced to 1.5 V.

TYPICAL CHARACTERISTICS

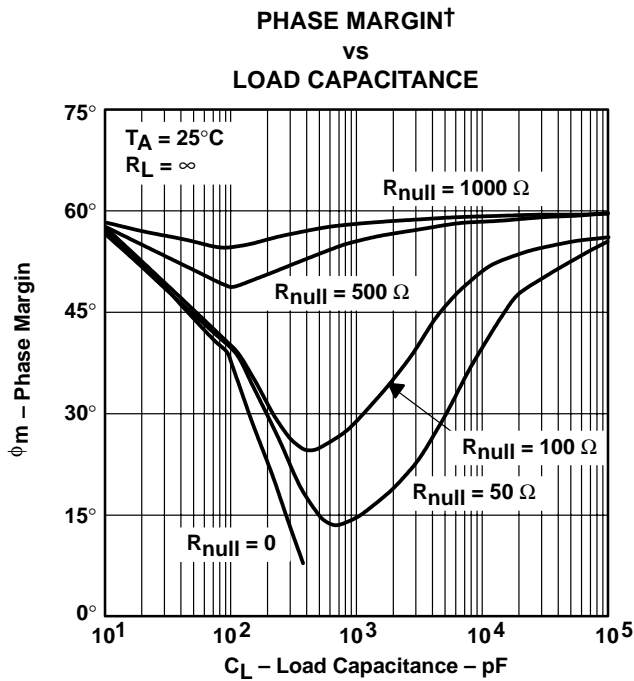

Figure 52

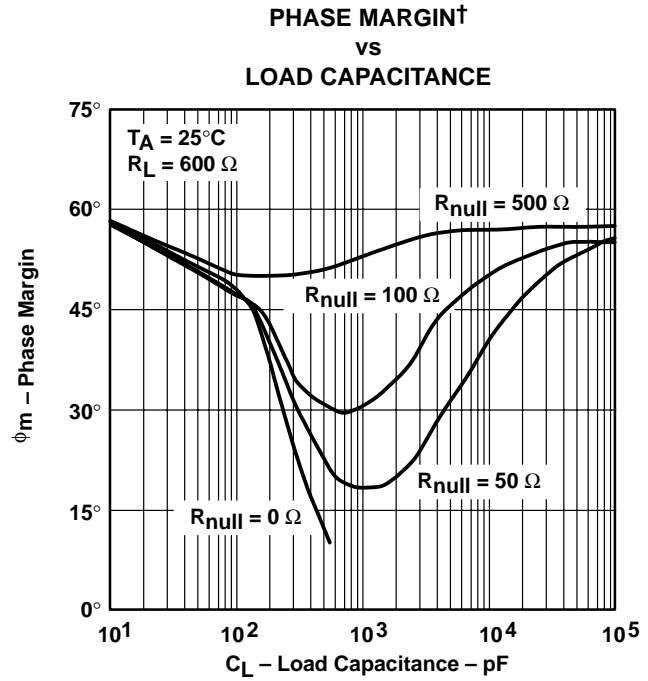

Figure 53

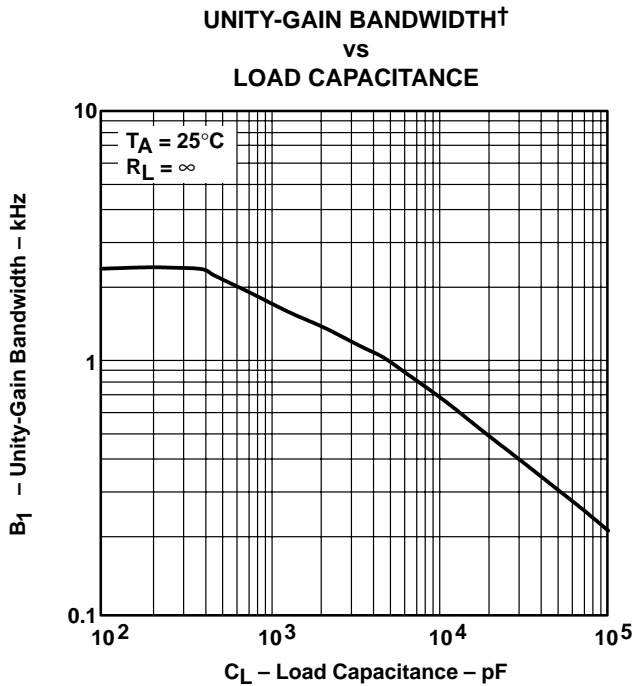

Figure 54

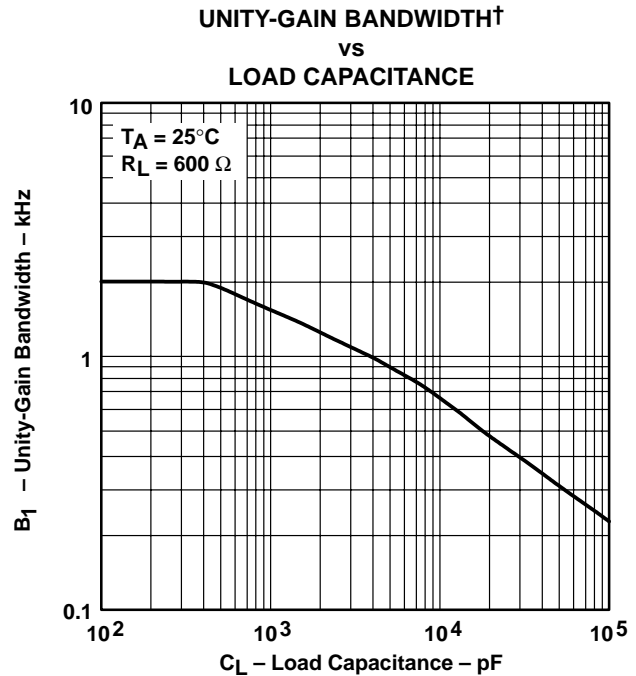

Figure 55

† For all curves where $V_{DD} = 5\text{ V}$, all loads are referenced to 2.5 V. For all curves where $V_{DD} = 3\text{ V}$, all loads are referenced to 1.5 V.

APPLICATION INFORMATION

driving large capacitive loads

The TLV2231 is designed to drive larger capacitive loads than most CMOS operational amplifiers. Figure 50 through Figure 55 illustrate its ability to drive loads greater than 100 pF while maintaining good gain and phase margins ($R_{null} = 0$).

A small series resistor (R_{null}) at the output of the device (see Figure 56) improves the gain and phase margins when driving large capacitive loads. Figure 50 through Figure 53 show the effects of adding series resistances of 50 Ω , 100 Ω , 500 Ω , and 1000 Ω . The addition of this series resistor has two effects: the first effect is that it adds a zero to the transfer function and the second effect is that it reduces the frequency of the pole associated with the output load in the transfer function.

The zero introduced to the transfer function is equal to the series resistance times the load capacitance. To calculate the approximate improvement in phase margin, equation 1 can be used.

$$\Delta\phi_{m1} = \tan^{-1} \left(2 \times \pi \times \text{UGBW} \times R_{null} \times C_L \right) \quad (1)$$

Where :

$\Delta\phi_{m1}$ = Improvement in phase margin

UGBW = Unity – gain bandwidth frequency

R_{null} = Output series resistance

C_L = Load capacitance

The unity-gain bandwidth (UGBW) frequency decreases as the capacitive load increases (see Figure 54 and Figure 55). To use equation 1, UGBW must be approximated from Figure 54 and Figure 55.

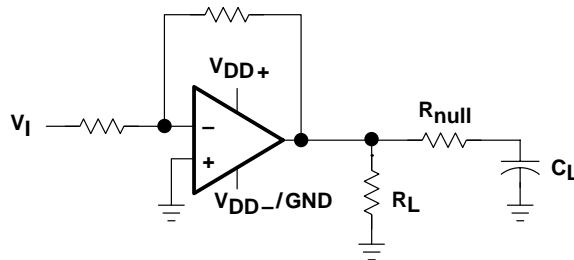

Figure 56. Series-Resistance Circuit

PACKAGING INFORMATION

Orderable Device	Status ⁽¹⁾	Package Type	Package Drawing	Pins	Package Qty	Eco Plan ⁽²⁾	Lead/Ball Finish	MSL Peak Temp ⁽³⁾
TLV2231CDBVR	ACTIVE	SOT-23	DBV	5	3000	Green (RoHS & no Sb/Br)	CU NIPDAU	Level-1-260C-UNLIM
TLV2231CDBVRG4	ACTIVE	SOT-23	DBV	5	3000	Green (RoHS & no Sb/Br)	CU NIPDAU	Level-1-260C-UNLIM
TLV2231CDBVT	ACTIVE	SOT-23	DBV	5	250	Green (RoHS & no Sb/Br)	CU NIPDAU	Level-1-260C-UNLIM
TLV2231CDBVTG4	ACTIVE	SOT-23	DBV	5	250	Green (RoHS & no Sb/Br)	CU NIPDAU	Level-1-260C-UNLIM
TLV2231IDBVR	ACTIVE	SOT-23	DBV	5	3000	Green (RoHS & no Sb/Br)	CU NIPDAU	Level-1-260C-UNLIM
TLV2231IDBVRG4	ACTIVE	SOT-23	DBV	5	3000	Green (RoHS & no Sb/Br)	CU NIPDAU	Level-1-260C-UNLIM
TLV2231IDBVT	ACTIVE	SOT-23	DBV	5	250	Green (RoHS & no Sb/Br)	CU NIPDAU	Level-1-260C-UNLIM
TLV2231IDBVTG4	ACTIVE	SOT-23	DBV	5	250	Green (RoHS & no Sb/Br)	CU NIPDAU	Level-1-260C-UNLIM

⁽¹⁾ The marketing status values are defined as follows:

ACTIVE: Product device recommended for new designs.

LIFEBUY: TI has announced that the device will be discontinued, and a lifetime-buy period is in effect.

NRND: Not recommended for new designs. Device is in production to support existing customers, but TI does not recommend using this part in a new design.

PREVIEW: Device has been announced but is not in production. Samples may or may not be available.

OBSOLETE: TI has discontinued the production of the device.

⁽²⁾ Eco Plan - The planned eco-friendly classification: Pb-Free (RoHS), Pb-Free (RoHS Exempt), or Green (RoHS & no Sb/Br) - please check <http://www.ti.com/productcontent> for the latest availability information and additional product content details.

TBD: The Pb-Free/Green conversion plan has not been defined.

Pb-Free (RoHS): TI's terms "Lead-Free" or "Pb-Free" mean semiconductor products that are compatible with the current RoHS requirements for all 6 substances, including the requirement that lead not exceed 0.1% by weight in homogeneous materials. Where designed to be soldered at high temperatures, TI Pb-Free products are suitable for use in specified lead-free processes.

Pb-Free (RoHS Exempt): This component has a RoHS exemption for either 1) lead-based flip-chip solder bumps used between the die and package, or 2) lead-based die adhesive used between the die and leadframe. The component is otherwise considered Pb-Free (RoHS compatible) as defined above.

Green (RoHS & no Sb/Br): TI defines "Green" to mean Pb-Free (RoHS compatible), and free of Bromine (Br) and Antimony (Sb) based flame retardants (Br or Sb do not exceed 0.1% by weight in homogeneous material)

⁽³⁾ MSL, Peak Temp. -- The Moisture Sensitivity Level rating according to the JEDEC industry standard classifications, and peak solder temperature.

Important Information and Disclaimer:The information provided on this page represents TI's knowledge and belief as of the date that it is provided. TI bases its knowledge and belief on information provided by third parties, and makes no representation or warranty as to the accuracy of such information. Efforts are underway to better integrate information from third parties. TI has taken and continues to take reasonable steps to provide representative and accurate information but may not have conducted destructive testing or chemical analysis on incoming materials and chemicals. TI and TI suppliers consider certain information to be proprietary, and thus CAS numbers and other limited information may not be available for release.

In no event shall TI's liability arising out of such information exceed the total purchase price of the TI part(s) at issue in this document sold by TI to Customer on an annual basis.

TAPE AND REEL INFORMATION



QUADRANT ASSIGNMENTS FOR PIN 1 ORIENTATION IN TAPE



*All dimensions are nominal

Device	Package Type	Package Drawing	Pins	SPQ	Reel Diameter (mm)	Reel Width W1 (mm)	A0 (mm)	B0 (mm)	K0 (mm)	P1 (mm)	W (mm)	Pin1 Quadrant
TLV2231CDBVR	SOT-23	DBV	5	3000	180.0	9.0	3.15	3.2	1.4	4.0	8.0	Q3
TLV2231CDBVT	SOT-23	DBV	5	250	180.0	9.0	3.15	3.2	1.4	4.0	8.0	Q3
TLV2231IDBVR	SOT-23	DBV	5	3000	180.0	9.0	3.15	3.2	1.4	4.0	8.0	Q3
TLV2231IDBVT	SOT-23	DBV	5	250	180.0	9.0	3.15	3.2	1.4	4.0	8.0	Q3

TAPE AND REEL BOX DIMENSIONS



*All dimensions are nominal

Device	Package Type	Package Drawing	Pins	SPQ	Length (mm)	Width (mm)	Height (mm)
TLV2231CDBVR	SOT-23	DBV	5	3000	182.0	182.0	20.0
TLV2231CDBVT	SOT-23	DBV	5	250	182.0	182.0	20.0
TLV2231IDBVR	SOT-23	DBV	5	3000	182.0	182.0	20.0
TLV2231IDBVT	SOT-23	DBV	5	250	182.0	182.0	20.0

IMPORTANT NOTICE

Texas Instruments Incorporated and its subsidiaries (TI) reserve the right to make corrections, modifications, enhancements, improvements, and other changes to its products and services at any time and to discontinue any product or service without notice. Customers should obtain the latest relevant information before placing orders and should verify that such information is current and complete. All products are sold subject to TI's terms and conditions of sale supplied at the time of order acknowledgment.

TI warrants performance of its hardware products to the specifications applicable at the time of sale in accordance with TI's standard warranty. Testing and other quality control techniques are used to the extent TI deems necessary to support this warranty. Except where mandated by government requirements, testing of all parameters of each product is not necessarily performed.

TI assumes no liability for applications assistance or customer product design. Customers are responsible for their products and applications using TI components. To minimize the risks associated with customer products and applications, customers should provide adequate design and operating safeguards.

TI does not warrant or represent that any license, either express or implied, is granted under any TI patent right, copyright, mask work right, or other TI intellectual property right relating to any combination, machine, or process in which TI products or services are used. Information published by TI regarding third-party products or services does not constitute a license from TI to use such products or services or a warranty or endorsement thereof. Use of such information may require a license from a third party under the patents or other intellectual property of the third party, or a license from TI under the patents or other intellectual property of TI.

Reproduction of TI information in TI data books or data sheets is permissible only if reproduction is without alteration and is accompanied by all associated warranties, conditions, limitations, and notices. Reproduction of this information with alteration is an unfair and deceptive business practice. TI is not responsible or liable for such altered documentation. Information of third parties may be subject to additional restrictions.

Resale of TI products or services with statements different from or beyond the parameters stated by TI for that product or service voids all express and any implied warranties for the associated TI product or service and is an unfair and deceptive business practice. TI is not responsible or liable for any such statements.

TI products are not authorized for use in safety-critical applications (such as life support) where a failure of the TI product would reasonably be expected to cause severe personal injury or death, unless officers of the parties have executed an agreement specifically governing such use. Buyers represent that they have all necessary expertise in the safety and regulatory ramifications of their applications, and acknowledge and agree that they are solely responsible for all legal, regulatory and safety-related requirements concerning their products and any use of TI products in such safety-critical applications, notwithstanding any applications-related information or support that may be provided by TI. Further, Buyers must fully indemnify TI and its representatives against any damages arising out of the use of TI products in such safety-critical applications.

TI products are neither designed nor intended for use in military/aerospace applications or environments unless the TI products are specifically designated by TI as military-grade or "enhanced plastic." Only products designated by TI as military-grade meet military specifications. Buyers acknowledge and agree that any such use of TI products which TI has not designated as military-grade is solely at the Buyer's risk, and that they are solely responsible for compliance with all legal and regulatory requirements in connection with such use.

TI products are neither designed nor intended for use in automotive applications or environments unless the specific TI products are designated by TI as compliant with ISO/TS 16949 requirements. Buyers acknowledge and agree that, if they use any non-designated products in automotive applications, TI will not be responsible for any failure to meet such requirements.

Following are URLs where you can obtain information on other Texas Instruments products and application solutions:

Products

Amplifiers	amplifier.ti.com
Data Converters	dataconverter.ti.com
DSP	dsp.ti.com
Clocks and Timers	www.ti.com/clocks
Interface	interface.ti.com
Logic	logic.ti.com
Power Mgmt	power.ti.com
Microcontrollers	microcontroller.ti.com
RFID	www.ti-rfid.com
RF/IF and ZigBee® Solutions	www.ti.com/lprf

Applications

Audio	www.ti.com/audio
Automotive	www.ti.com/automotive
Broadband	www.ti.com/broadband
Digital Control	www.ti.com/digitalcontrol
Medical	www.ti.com/medical
Military	www.ti.com/military
Optical Networking	www.ti.com/opticalnetwork
Security	www.ti.com/security
Telephony	www.ti.com/telephony
Video & Imaging	www.ti.com/video
Wireless	www.ti.com/wireless

Mailing Address: Texas Instruments, Post Office Box 655303, Dallas, Texas 75265
Copyright © 2008, Texas Instruments Incorporated