

THIS DOCUMENT IS THE PROPERTY OF
KEYSTONE ELECTRONICS CORP. AND
SHALL NOT BE REPRODUCED, DISTRIBUTED
OR USED AS A BASIS FOR MANUFACTURE
WITHOUT PRIOR WRITTEN PERMISSION
FROM KEYSTONE ELECTRONICS CORP.

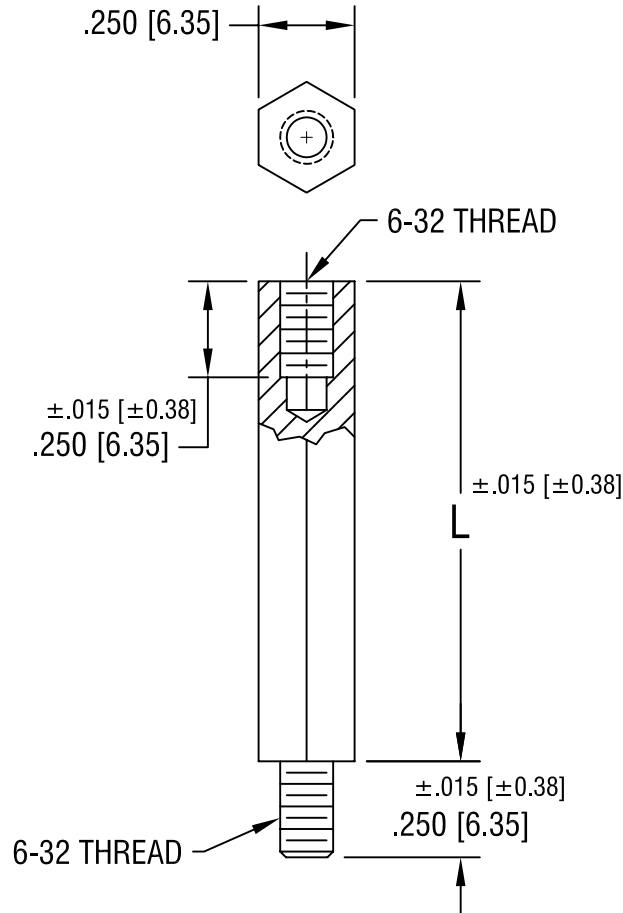

PART NO.	'L' DIM.
4822	1.250 [31.75]
4823	1.375 [34.93]
4824	1.500 [38.10]
4825	1.625 [41.28]
4826	1.750 [44.45]
4827	2.000 [50.80]

KEYSTONE ELECTRONICS CORP.

ASTORIA, N.Y. 11105-2017

PART NAME

NYLON M/F HEX STANDOFF

MATERIAL

NYLON 6/6

FINISH

-

DRN BY

BOONE

DATE

5.9.96

APP'D

LN

SCALE

2X

TOLERANCES

INCH [MM]

DECIMAL ± .005 [± 0.15]

ANGULAR ± 1°
UNLESS OTHERWISE SPECIFIED

CODE

C/M

DWG NO.

4822-4827

DATE	DESCRIPTION	REV.

Mouser Electronics

Authorized Distributor

Click to View Pricing, Inventory, Delivery & Lifecycle Information:

[Keystone Electronics:](#)

[4825](#)