

## 35 W bridge car radio amplifier

Datasheet - production data

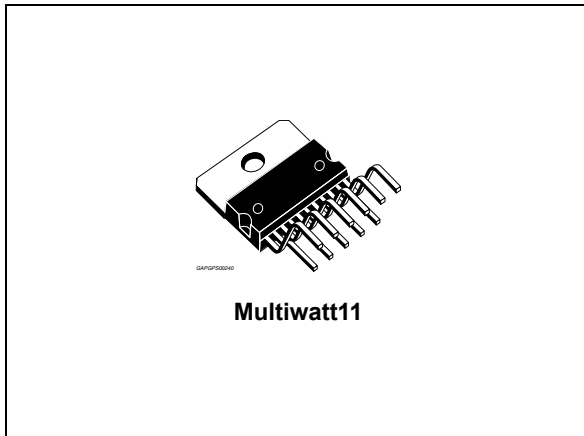

### Features

- High power capability:
  - 40 W/4  $\Omega$  max
  - 35 W/4  $\Omega$  EIAJ
  - 45 W/3.2  $\Omega$  max
  - 40 W/3.2  $\Omega$  EIAJ
  - 32 W/3.2  $\Omega$  @  $V_S = 14.4$  V,  $f = 1$  kHz,  $d = 10$  %
  - 26 W/4  $\Omega$  @  $V_S = 14.4$  V,  $f = 1$  kHz,  $d = 10$  %
- Differential inputs (either single ended or differential input signal are accepted)
- Minimum external component count:
  - No bootstrap capacitors
  - No Boucherot cells

- Internally fixed gain (30 dB)
- No SVR Capacitor
- Standby function (CMOS compatible)
- Programmable turn-on/off delay
- No audible pop during mute and standby operations
- Protections:
  - Short circuit (to GND, to  $V_S$ , across the load)
  - Very inductive loads
  - Chip over temperature
  - Load dump
  - Open GND
  - ESD

### Description

The TDA7391 is a bridge class AB audio power amplifier specially intended for car radio high power applications.

The high power capability together with the possibility to operate either in differential input mode or single ended input mode makes it suitable for boosters and high end car radio equipments. The exclusive fully complementary output stage and the internal fixed gain configuration drop the external component count.

The on board clipping detector allows easy implementation of gain compression systems.

**Table 1. Device summary**

Order code	Package	Packing
TDA7391	Multiwatt11 (vertical)	Tube

# Contents

- 1      Block and pin description diagrams ..... 5**
  - 1.1    Block diagram ..... 5
  - 1.2    Pin description ..... 5
  
- 2      Electrical specifications ..... 7**
  - 2.1    Absolute maximum ratings ..... 7
  - 2.2    Thermal data ..... 7
  - 2.3    Electrical characteristics ..... 7
  - 2.4    Electrical characteristics curves ..... 9
  
- 3      Package information ..... 11**
  
- 4      Revision history ..... 12**

## List of tables

Table 1.	Device summary . . . . .	1
Table 2.	Pin functional description . . . . .	6
Table 3.	Absolute maximum ratings . . . . .	7
Table 4.	Thermal data . . . . .	7
Table 5.	Electrical characteristics . . . . .	7
Table 6.	Document revision history . . . . .	12

## List of figures

Figure 1.	Block diagram . . . . .	5
Figure 2.	Pin connection (top view) . . . . .	5
Figure 3.	Test and application circuit . . . . .	8
Figure 4.	Printed circuit board and component layout of the Figure 4 . . . . .	9
Figure 5.	Quiescent current vs. supply voltage . . . . .	9
Figure 6.	EIAJ power vs. supply voltage . . . . .	9
Figure 7.	Output power vs. supply voltage ( $R_L = 4 \Omega$ ) . . . . .	9
Figure 8.	Distortion vs. frequency ( $R_L = 4 \Omega$ ) . . . . .	9
Figure 9.	Output power vs. supply voltage ( $R_L = 3.2 \Omega$ ) . . . . .	10
Figure 10.	Distortion vs. frequency ( $R_L = 3.2 \Omega$ ) . . . . .	10
Figure 11.	Supply voltage rejection vs. frequency . . . . .	10
Figure 12.	Common mode rejection vs. frequency . . . . .	10
Figure 13.	Total power dissipation and efficiency vs. output power ( $R_L = 4\Omega$ ) . . . . .	10
Figure 14.	Power bandwidth . . . . .	10
Figure 15.	Multiwatt11 (vertical) mechanical data and package dimensions . . . . .	11

# 1 Block and pin description diagrams

## 1.1 Block diagram

Figure 1. Block diagram

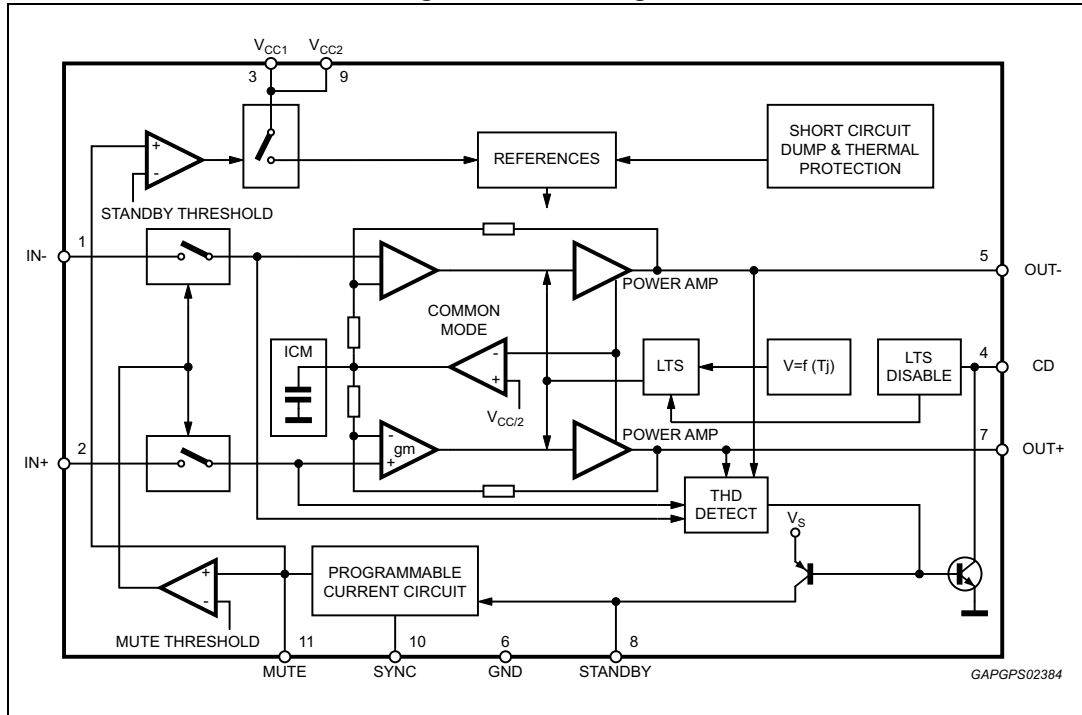

## 1.2 Pin description

Figure 2. Pin connection (top view)

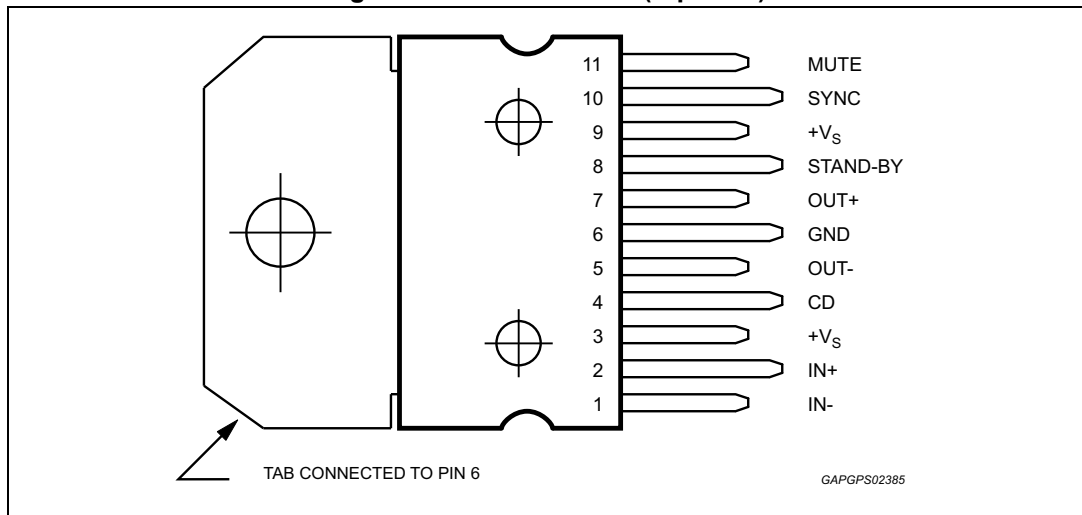

Table 2. Pin functional description

Pin#	Pin name	Description
1, 2	INPUTS	The input stage is a high impedance type also capable of operation in single ended mode with one input capacitively coupled to the signal GND. The impedance seen by the inverting and non inverting input pins must be matched.
3,9	+V	Supply voltage.
4	CD	The TDA7391 is equipped with a diagnostic circuitry able to detect the clipping in the Output Signal (distortion = 10%). The CD pin (open collector) gives out low level signal during clipping.
5, 7	OUTPUTS	The output stage is a bridge type able to drive loads as low as $3.2\Omega$ . It consists of two class AB fully complementary PNP/NPN stages fully protected. A rail to rail output voltage swing is achieved without need of bootstrap capacitors. No external compensation is necessary.
6	GND	Ground.
8	STAND-BY	The device features a standby function which shuts down all the internal bias supplies when the STAND-BY pin is low. In standby mode the amplifier sinks a small current (in the range of few $\mu\text{A}$ ). When the STAND-BY pin is high the IC becomes fully operational.
10	SYNC	A resistor ( $R_2$ ) has to be connect between pin 10 and GND in order to program the current that flows in the $C_3$ capacitor (pin 11). The values of $C_3$ and $R_2$ determine the time required to bias the amplifier.
11	MUTE	The pin will have a capacitor ( $C_3$ ) tied to GND to set the MUTE/STAND-BY time. An automatic Mute during turn on/off is provided to prevent noisy transients.

## 2 Electrical specifications

### 2.1 Absolute maximum ratings

Table 3. Absolute maximum ratings

Symbol	Parameter	Value	Unit
$V_S$	DC supply voltage	28	V
$V_{OP}$	Operating supply voltage	18	V
$V_{PEAK}$	Peak supply voltage (t = 50 ms)	50	V
$I_O$	Output peak current repetitive (f > 10 Hz)	4.5	A
	Output peak current non repetitive	6	A
$P_{tot}$	Power dissipation ( $T_{case} = 85\text{ °C}$ )	43	W
$T_{stg}, T_j$	Storage and junction temperature <sup>(1)</sup>	-40 to 150	°C
$T_{amb}$	Operative ambient temperature range	-40 to 105	°C

1. A suitable heatsink/dissipation system should be used to keep  $T_j$  inside specified limits.

### 2.2 Thermal data

Table 4. Thermal data

Symbol	Parameter	Value	Unit
$R_{th\ j-case}$	Thermal resistance junction to case	Max 1.8	°C/W

### 2.3 Electrical characteristics

Refer to the test circuit,  $V_S = 14.4\text{ V}$ ;  $R_L = 4\ \Omega$ ,  $f = 1\text{ kHz}$ ,  $T_{amb} = 25\text{ °C}$ ; unless otherwise specified.

Table 5. Electrical characteristics

Symbol	Parameter	Test condition	Min.	Typ.	Max.	Unit
$V_S$	Supply voltage range	-	8	-	18	V
$I_q$	Total quiescent current	-	-	60	150	mA
$V_{OS}$	Output offset voltage	-	-	-	120	mV
$I_{SB}$	Standby current	$V_{ST-BY} = 1.5\text{ V}$	-	-	100	μA
$I_{SBin}$	Standby input bias current	$V_{ST-BY} = 5\text{ V}$	-	-	10	μA
$V_{SBon}$	Standby On threshold voltage	-	-	-	1.5	V
$V_{SBoff}$	Standby Off threshold voltage	-	3.5	-	-	V
$ATT_{ST-BY}$	Standby attenuation	-	--	90	-	dB
$I_{M\_in}$	Mute input bias current	$V_{MUTE} = 5\text{ V}$	-	-	10	μA

Table 5. Electrical characteristics (continued)

Symbol	Parameter	Test condition	Min.	Typ.	Max.	Unit
$A_M$	Mute attenuation	-	-	90	-	dB
$P_O$	Output power	$d = 10\%$	20	26	-	W
		$d = 1\%$	-	21	-	W
		$d = 10\%; R_L = 3.2\ \Omega$	-	32	-	W
$P_{O\ EIAJ}$	EIAJ output power <sup>(1)</sup>	$V_S = 13.7\ V; R_L = 3.2\ \Omega$	-	40	-	W
$P_{O\ MAX}$	Max. output power <sup>(1)</sup>	$V_S = 14.4\ V; R_L = 3.2\ \Omega$	-	45	-	W
$d$	Distortion	-	-	0.06	-	%
		$P_O = 0.1\ \text{to}\ 15\ W$	-	0.03	-	%
$G_V$	Voltage gain	-	29.5	30	30.5	dB
$f_H$	High frequency roll-off	$P_O = 1W; -3dB$	75	-	-	kHz
$R_{IN}$	Input Impedance	Differential	36	60	-	k $\Omega$
		Single Ended	30	55	-	k $\Omega$
$E_{IN}$	Input noise voltage	$R_g = 0\ \Omega; f = 22\ Hz\ \text{to}\ 22\ kHz$	-	4	-	mV
CMRR	Input common mode rejection	$f = 1\ kHz; V_{IN} = 1\ V_{rms}$	-	65	-	dB
SVR	Supply voltage rejection	$R_g = 0\ \Omega; V_r = 1\ V_{rms}$	-	60	-	dB
CDL	Clipping detection level	-	5	10	15	%
$T_{sd}$	Absolute thermal shutdown junction temperature	-	-	160	-	$^{\circ}C$

1. Saturated square wave output.

Figure 3. Test and application circuit

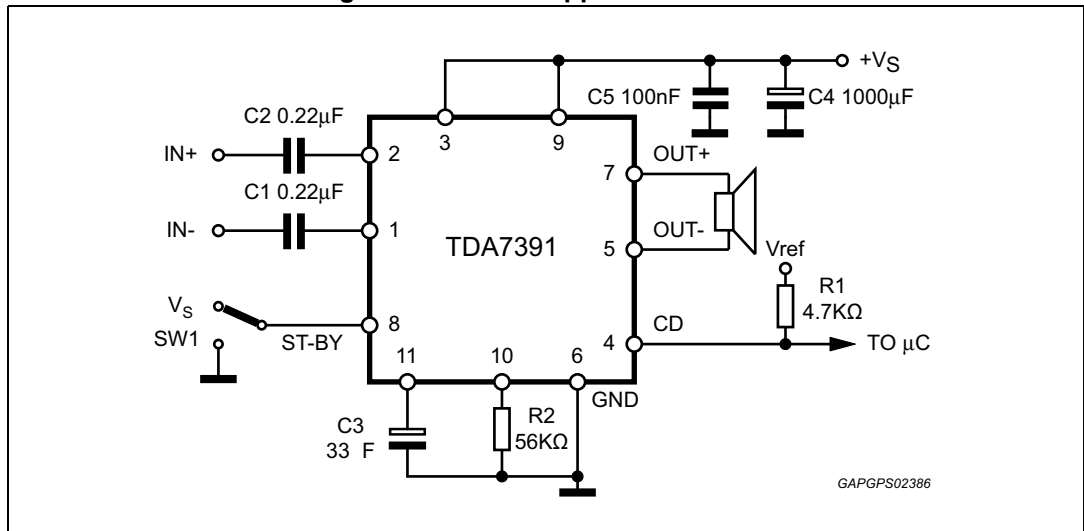
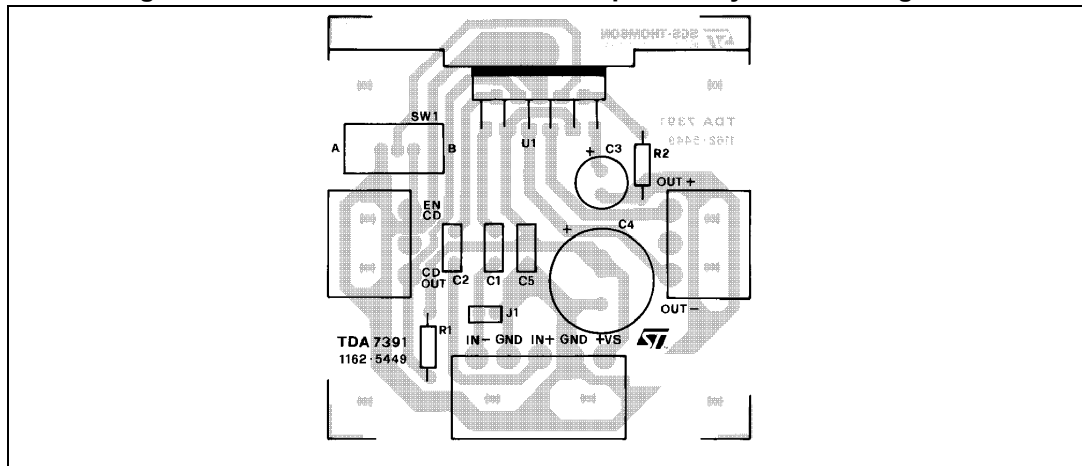



Figure 4. Printed circuit board and component layout of the Figure 4



## 2.4 Electrical characteristics curves

Figure 5. Quiescent current vs. supply voltage

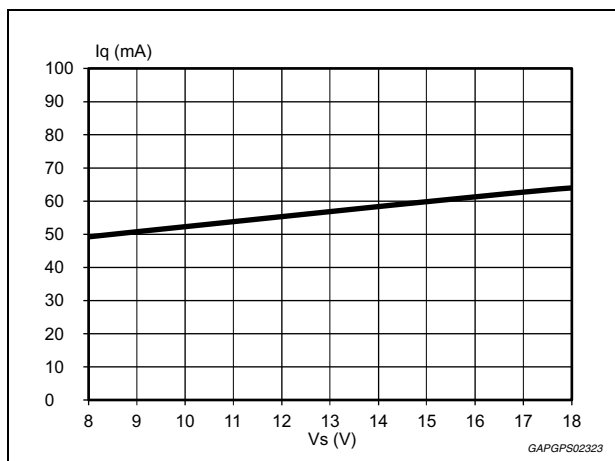

Figure 7. Output power vs. supply voltage ( $R_L = 4 \Omega$ )

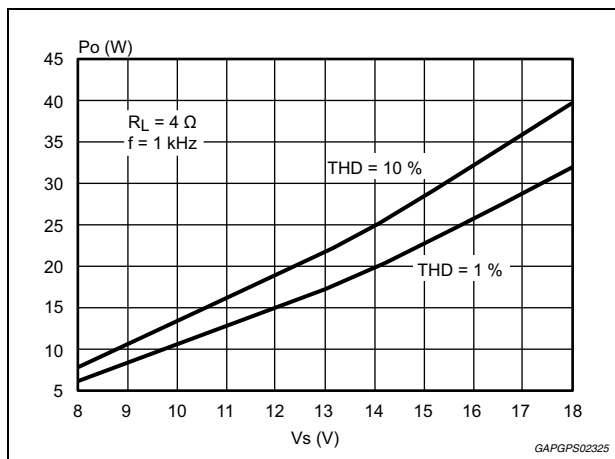

Figure 6. EIAJ power vs. supply voltage

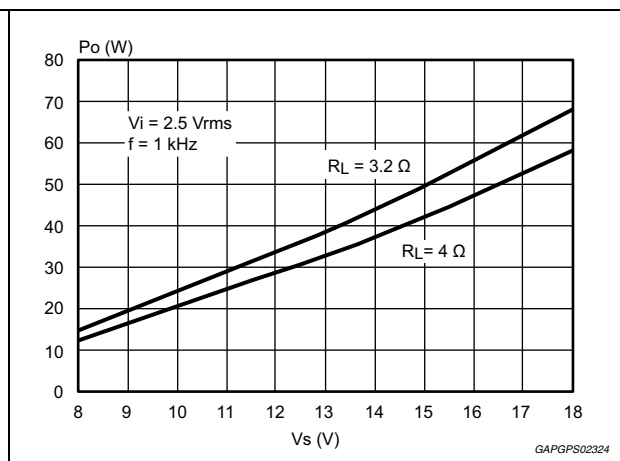
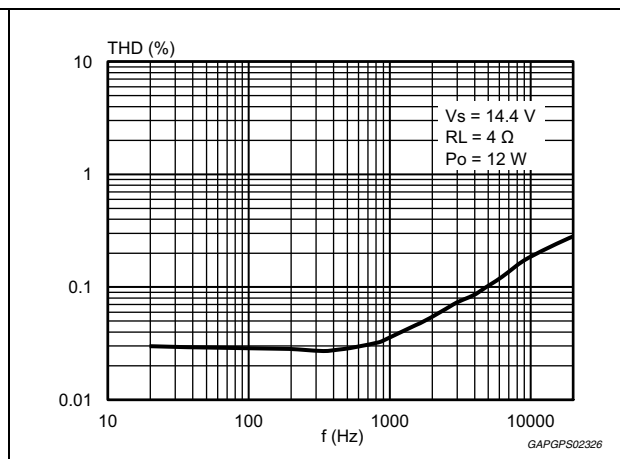
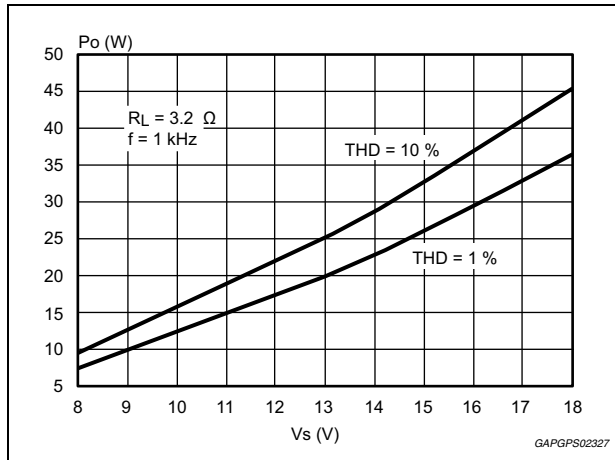

Figure 8. Distortion vs. frequency ( $R_L = 4 \Omega$ )



**Figure 9. Output power vs. supply voltage**  
( $R_L = 3.2 \Omega$ )



**Figure 10. Distortion vs. frequency**  
( $R_L = 3.2 \Omega$ )

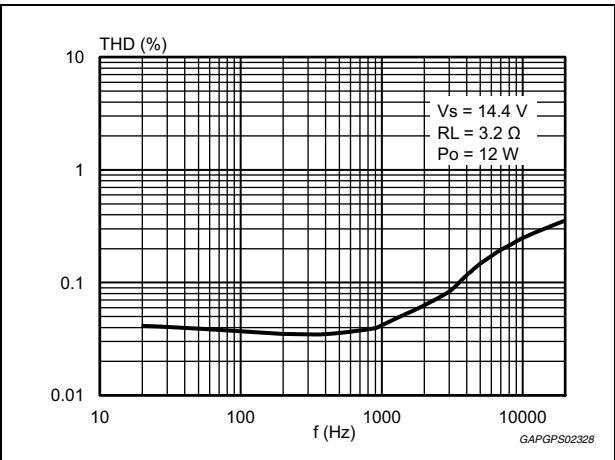

**Figure 11. Supply voltage rejection vs. frequency**

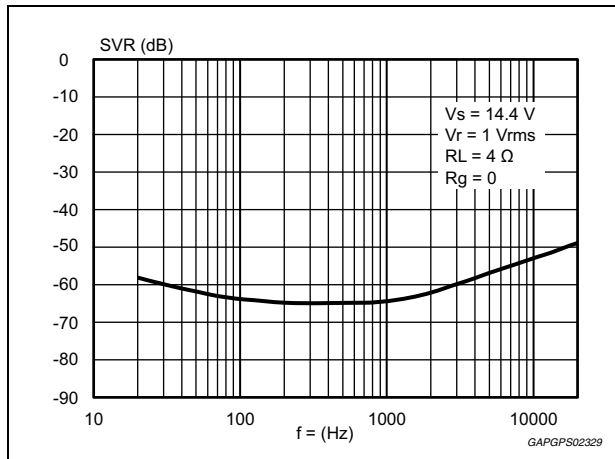

**Figure 12. Common mode rejection vs. frequency**

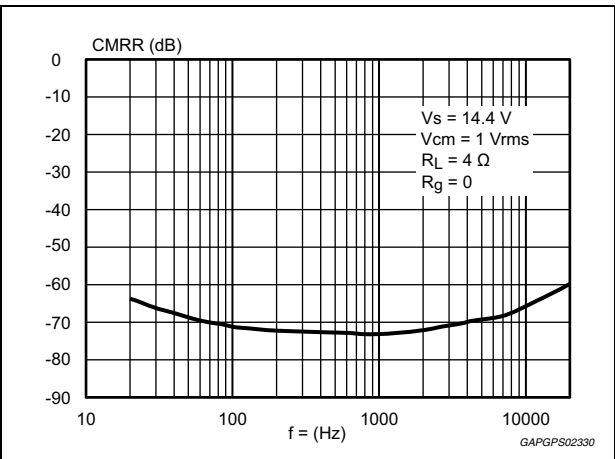

**Figure 13. Total power dissipation and efficiency vs. output power ( $R_L = 4 \Omega$ )**

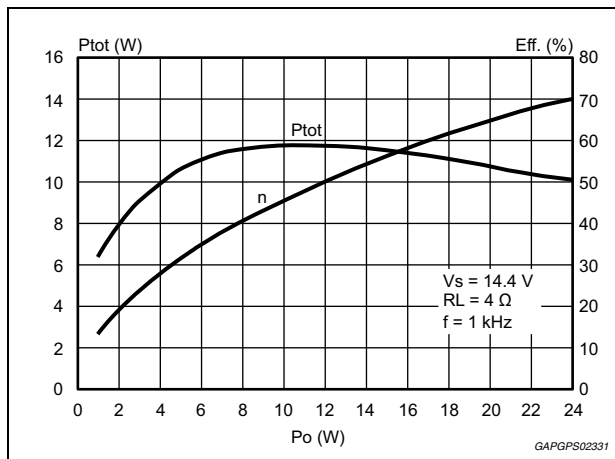

**Figure 14. Power bandwidth**

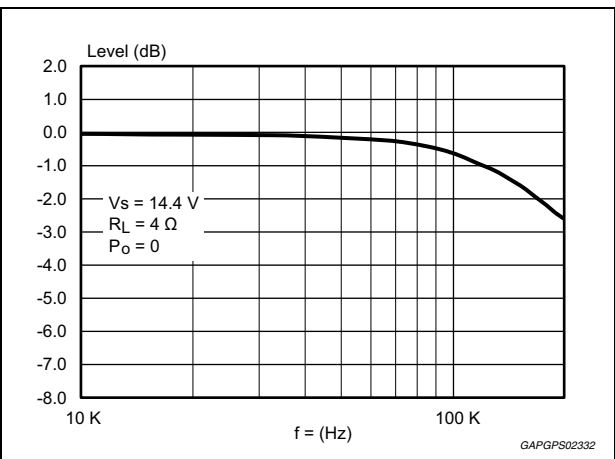

### 3 Package information

In order to meet environmental requirements, ST offers these devices in different grades of ECOPACK® packages, depending on their level of environmental compliance. ECOPACK® specifications, grade definitions and product status are available at: [www.st.com](http://www.st.com).

ECOPACK® is an ST trademark

**Figure 15. Multiwatt11 (vertical) mechanical data and package dimensions**

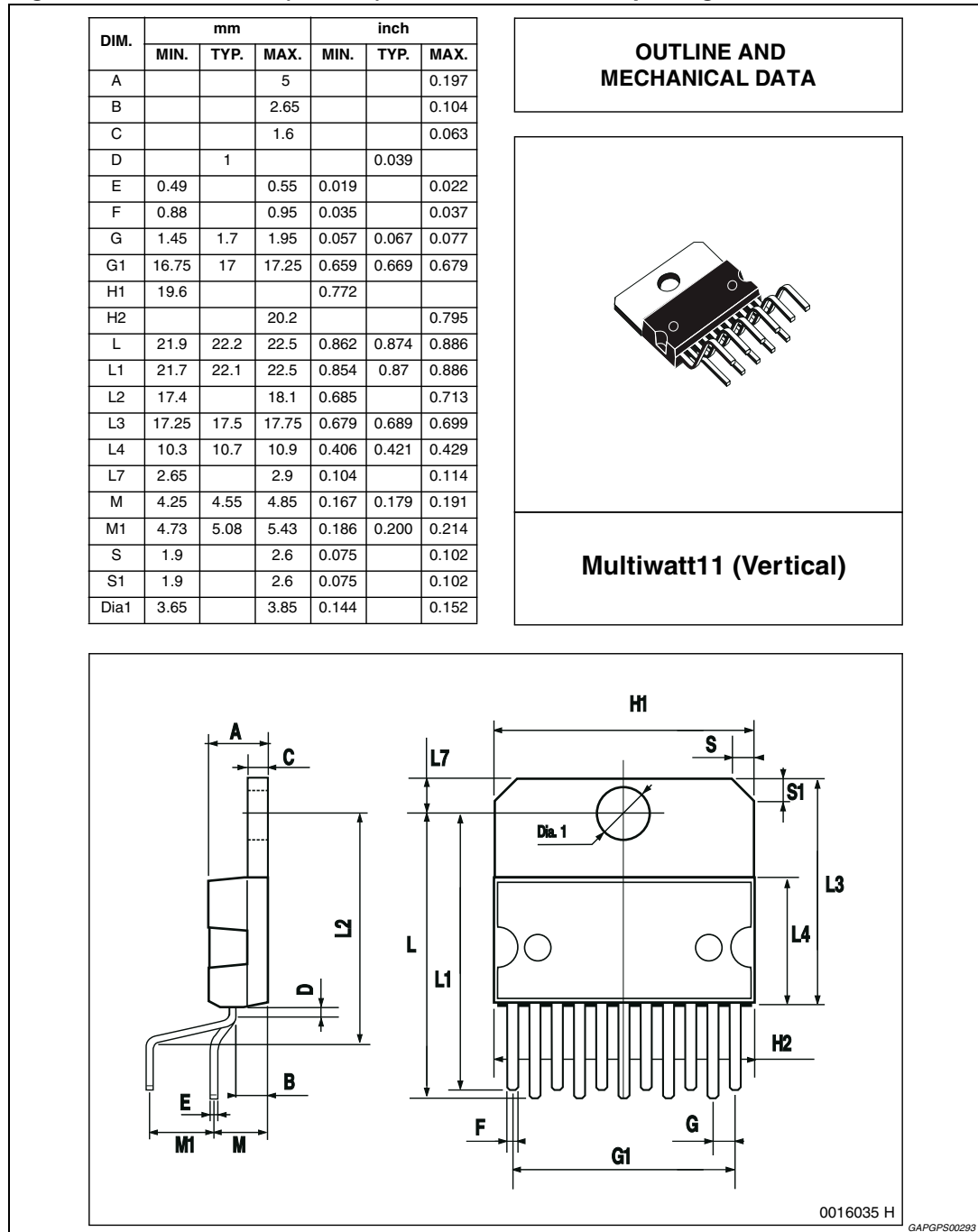

## 4 Revision history

**Table 6. Document revision history**

Date	Revision	Changes
24-May1998	3	Initial release.
19-Jun-2013	4	Updated <a href="#">Table 3: Absolute maximum ratings on page 7</a> .
18-Sep-2013	5	Updated Disclaimer.

**Please Read Carefully:**

Information in this document is provided solely in connection with ST products. STMicroelectronics NV and its subsidiaries ("ST") reserve the right to make changes, corrections, modifications or improvements, to this document, and the products and services described herein at any time, without notice.

All ST products are sold pursuant to ST's terms and conditions of sale.

Purchasers are solely responsible for the choice, selection and use of the ST products and services described herein, and ST assumes no liability whatsoever relating to the choice, selection or use of the ST products and services described herein.

No license, express or implied, by estoppel or otherwise, to any intellectual property rights is granted under this document. If any part of this document refers to any third party products or services it shall not be deemed a license grant by ST for the use of such third party products or services, or any intellectual property contained therein or considered as a warranty covering the use in any manner whatsoever of such third party products or services or any intellectual property contained therein.

**UNLESS OTHERWISE SET FORTH IN ST'S TERMS AND CONDITIONS OF SALE ST DISCLAIMS ANY EXPRESS OR IMPLIED WARRANTY WITH RESPECT TO THE USE AND/OR SALE OF ST PRODUCTS INCLUDING WITHOUT LIMITATION IMPLIED WARRANTIES OF MERCHANTABILITY, FITNESS FOR A PARTICULAR PURPOSE (AND THEIR EQUIVALENTS UNDER THE LAWS OF ANY JURISDICTION), OR INFRINGEMENT OF ANY PATENT, COPYRIGHT OR OTHER INTELLECTUAL PROPERTY RIGHT.**

**ST PRODUCTS ARE NOT DESIGNED OR AUTHORIZED FOR USE IN: (A) SAFETY CRITICAL APPLICATIONS SUCH AS LIFE SUPPORTING, ACTIVE IMPLANTED DEVICES OR SYSTEMS WITH PRODUCT FUNCTIONAL SAFETY REQUIREMENTS; (B) AERONAUTIC APPLICATIONS; (C) AUTOMOTIVE APPLICATIONS OR ENVIRONMENTS, AND/OR (D) AEROSPACE APPLICATIONS OR ENVIRONMENTS. WHERE ST PRODUCTS ARE NOT DESIGNED FOR SUCH USE, THE PURCHASER SHALL USE PRODUCTS AT PURCHASER'S SOLE RISK, EVEN IF ST HAS BEEN INFORMED IN WRITING OF SUCH USAGE, UNLESS A PRODUCT IS EXPRESSLY DESIGNATED BY ST AS BEING INTENDED FOR "AUTOMOTIVE, AUTOMOTIVE SAFETY OR MEDICAL" INDUSTRY DOMAINS ACCORDING TO ST PRODUCT DESIGN SPECIFICATIONS. PRODUCTS FORMALLY ESCC, QML OR JAN QUALIFIED ARE DEEMED SUITABLE FOR USE IN AEROSPACE BY THE CORRESPONDING GOVERNMENTAL AGENCY.**

Resale of ST products with provisions different from the statements and/or technical features set forth in this document shall immediately void any warranty granted by ST for the ST product or service described herein and shall not create or extend in any manner whatsoever, any liability of ST.

ST and the ST logo are trademarks or registered trademarks of ST in various countries.

Information in this document supersedes and replaces all information previously supplied.

The ST logo is a registered trademark of STMicroelectronics. All other names are the property of their respective owners.

© 2013 STMicroelectronics - All rights reserved

STMicroelectronics group of companies

Australia - Belgium - Brazil - Canada - China - Czech Republic - Finland - France - Germany - Hong Kong - India - Israel - Italy - Japan - Malaysia - Malta - Morocco - Philippines - Singapore - Spain - Sweden - Switzerland - United Kingdom - United States of America

[www.st.com](http://www.st.com)



# Mouser Electronics

Authorized Distributor

Click to View Pricing, Inventory, Delivery & Lifecycle Information:

[STMicroelectronics:](#)

[TDA7391](#)