

ZXMN2A02N8

20V N-CHANNEL ENHANCEMENT MODE MOSFET

SUMMARY

$V_{(BR)DSS} = 20V$; $R_{DS(ON)} = 0.02\Omega$; $I_D = 10.2A$

DESCRIPTION

This new generation of TRENCH MOSFETs from Zetex utilizes a unique structure that combines the benefits of low on-resistance with fast switching speed. This makes them ideal for high efficiency, low voltage, power management applications.

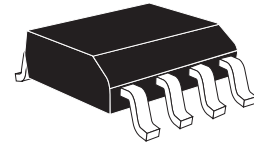

SO8

FEATURES

- Low on-resistance
- Fast switching speed
- Low threshold
- Low gate drive
- Low profile SOIC package

APPLICATIONS

- Disconnect switches
- Motor control

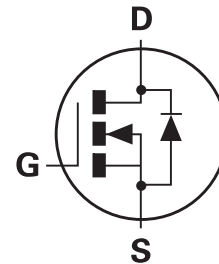

ORDERING INFORMATION

DEVICE	REEL SIZE	TAPE WIDTH	QUANTITY PER REEL
ZXMN2A02N8TA	7"	12mm	500 units
ZXMN2A02N8TC	13"	12mm	2500 units

DEVICE MARKING

- ZXMN
2A02

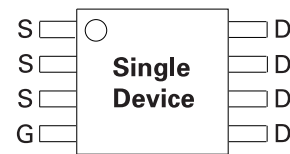

Top View

ZXMN2A02N8

ABSOLUTE MAXIMUM RATINGS

PARAMETER	SYMBOL	LIMIT	UNIT
Drain-Source Voltage	V_{DSS}	20	V
Gate Source Voltage	V_{GS}	± 12	V
Continuous Drain Current $V_{GS}=10V$; $T_A=25^\circ C$ ^(b) $V_{GS}=10V$; $T_A=70^\circ C$ ^(b) $V_{GS}=10V$; $T_A=25^\circ C$ ^(a)	I_D	10.2 8.2 8.3	A
Pulsed Drain Current ^(c)	I_{DM}	50	A
Continuous Source Current (Body Diode) ^(b)	I_S	4.3	A
Pulsed Source Current (Body Diode) ^(c)	I_{SM}	50	A
Power Dissipation at $T_A=25^\circ C$ ^(a) Linear Derating Factor	P_D	1.56 12.5	W mW/ $^\circ C$
Power Dissipation at $T_A=25^\circ C$ ^(b) Linear Derating Factor	P_D	2.5 20	W mW/ $^\circ C$
Operating and Storage Temperature Range	T_j ; T_{stg}	-55 to 150	$^\circ C$

THERMAL RESISTANCE

PARAMETER	SYMBOL	VALUE	UNIT
Junction to Ambient ^(a)	$R_{\theta JA}$	80	$^\circ C/W$
Junction to Ambient ^(b)	$R_{\theta JA}$	50	$^\circ C/W$

NOTES

(a) For a device surface mounted on 25mm x 25mm FR4 PCB with high coverage of single sided 1oz copper, in still air conditions

(b) For a device surface mounted on FR4 PCB measured at $t \leq 10$ secs.

(c) Repetitive rating 25mm x 25mm FR4 PCB, $D = 0.02$, pulse width 300 μs - pulse width limited by maximum junction temperature.

ZXMN2A02N8

CHARACTERISTICS

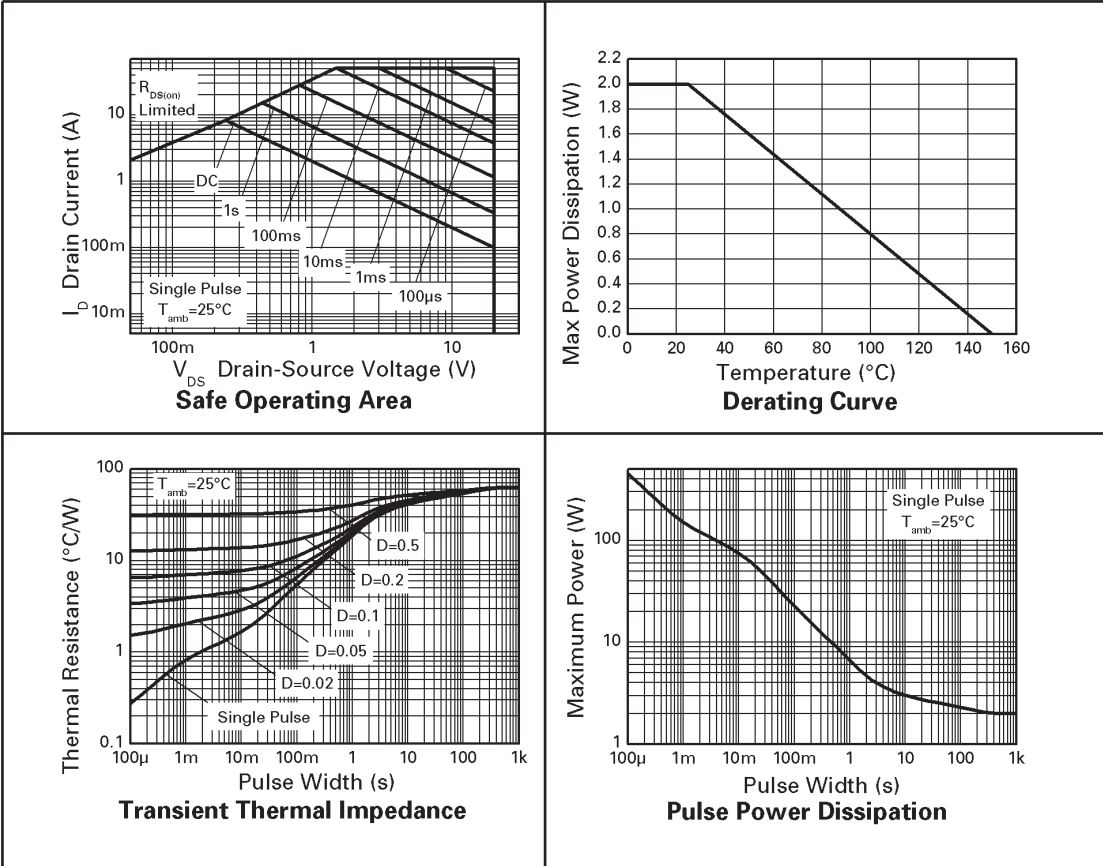

ZXMN2A02N8

ELECTRICAL CHARACTERISTICS (at $T_{amb} = 25^{\circ}\text{C}$ unless otherwise stated).

PARAMETER	SYMBOL	MIN.	TYP.	MAX.	UNIT	CONDITIONS.
STATIC						
Drain-Source Breakdown Voltage	$V_{(BR)DSS}$	20			V	$I_D=250\mu\text{A}, V_{GS}=0\text{V}$
Zero Gate Voltage Drain Current	I_{DSS}			1	μA	$V_{DS}=20\text{V}, V_{GS}=0\text{V}$
Gate-Body Leakage	I_{GSS}			100	nA	$V_{GS}=\pm 12\text{V}, V_{DS}=0\text{V}$
Gate-Source Threshold Voltage	$V_{GS(th)}$	0.7			V	$I_D=250\mu\text{A}, V_{DS}=V_{GS}$
Static Drain-Source On-State Resistance ⁽¹⁾	$R_{DS(on)}$			0.02	Ω	$V_{GS}=4.5\text{V}, I_D=11\text{A}$
				0.04	Ω	$V_{GS}=2.5\text{V}, I_D=8.4\text{A}$
Forward Transconductance ⁽¹⁾⁽³⁾	g_{fs}		27		S	$V_{DS}=10\text{V}, I_D=11\text{A}$
DYNAMIC ⁽³⁾						
Input Capacitance	C_{iss}		1900		pF	$V_{DS}=10\text{V}, V_{GS}=0\text{V},$ $f=1\text{MHz}$
Output Capacitance	C_{oss}		356		pF	
Reverse Transfer Capacitance	C_{rss}		218		pF	
SWITCHING ^{(2) (3)}						
Turn-On Delay Time	$t_{d(on)}$		7.9		ns	$V_{DD}=10\text{V}, I_D=1\text{A}$ $R_G=6.0\Omega, V_{GS}=4.5\text{V}$
Rise Time	t_r		10		ns	
Turn-Off Delay Time	$t_{d(off)}$		33.3		ns	
Fall Time	t_f		13.6		ns	
Total Gate Charge	Q_g		18.9		nC	$V_{DS}=10\text{V}, V_{GS}=4.5\text{V},$ $I_D=11\text{A}$
Gate-Source Charge	Q_{gs}		5.2		nC	
Gate-Drain Charge	Q_{gd}		4.9		nC	
SOURCE-DRAIN DIODE						
Diode Forward Voltage ⁽¹⁾	V_{SD}		0.85	0.95	V	$T_J=25^{\circ}\text{C}, I_S=11.5\text{A},$ $V_{GS}=0\text{V}$
Reverse Recovery Time ⁽³⁾	t_{rr}		16.3		ns	$T_J=25^{\circ}\text{C}, I_F=2.1\text{A},$ $di/dt= 100\text{A}/\mu\text{s}$
Reverse Recovery Charge ⁽³⁾	Q_{rr}		7.8		nC	

NOTES

- (1) Measured under pulsed conditions. Width $\leq 300\mu\text{s}$. Duty cycle $\leq 2\%$.
 (2) Switching characteristics are independent of operating junction temperature.
 (3) For design aid only, not subject to production testing.

ZXMN2A02N8

CHARACTERISTICS

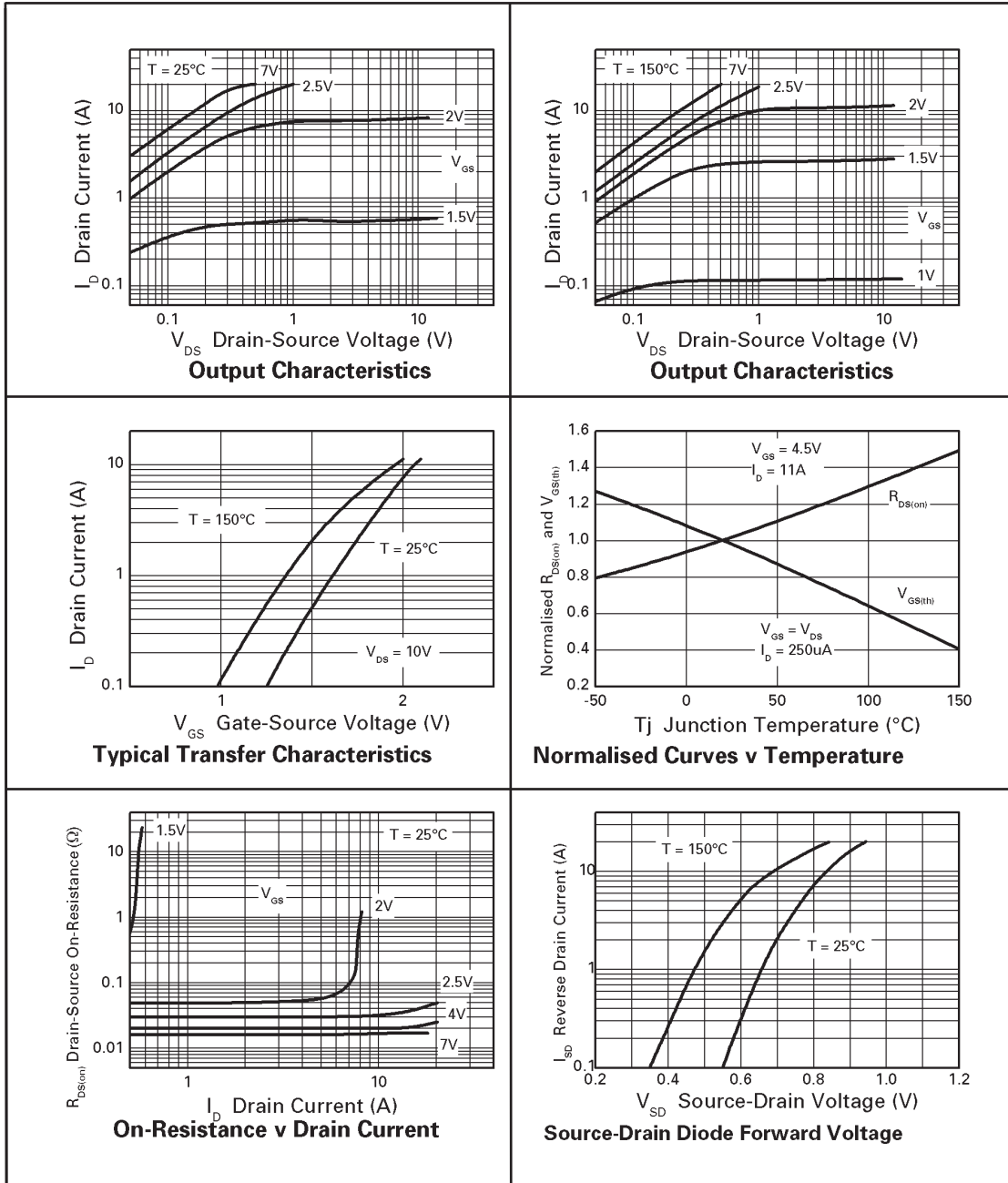

ZXMN2A02N8

CHARACTERISTICS

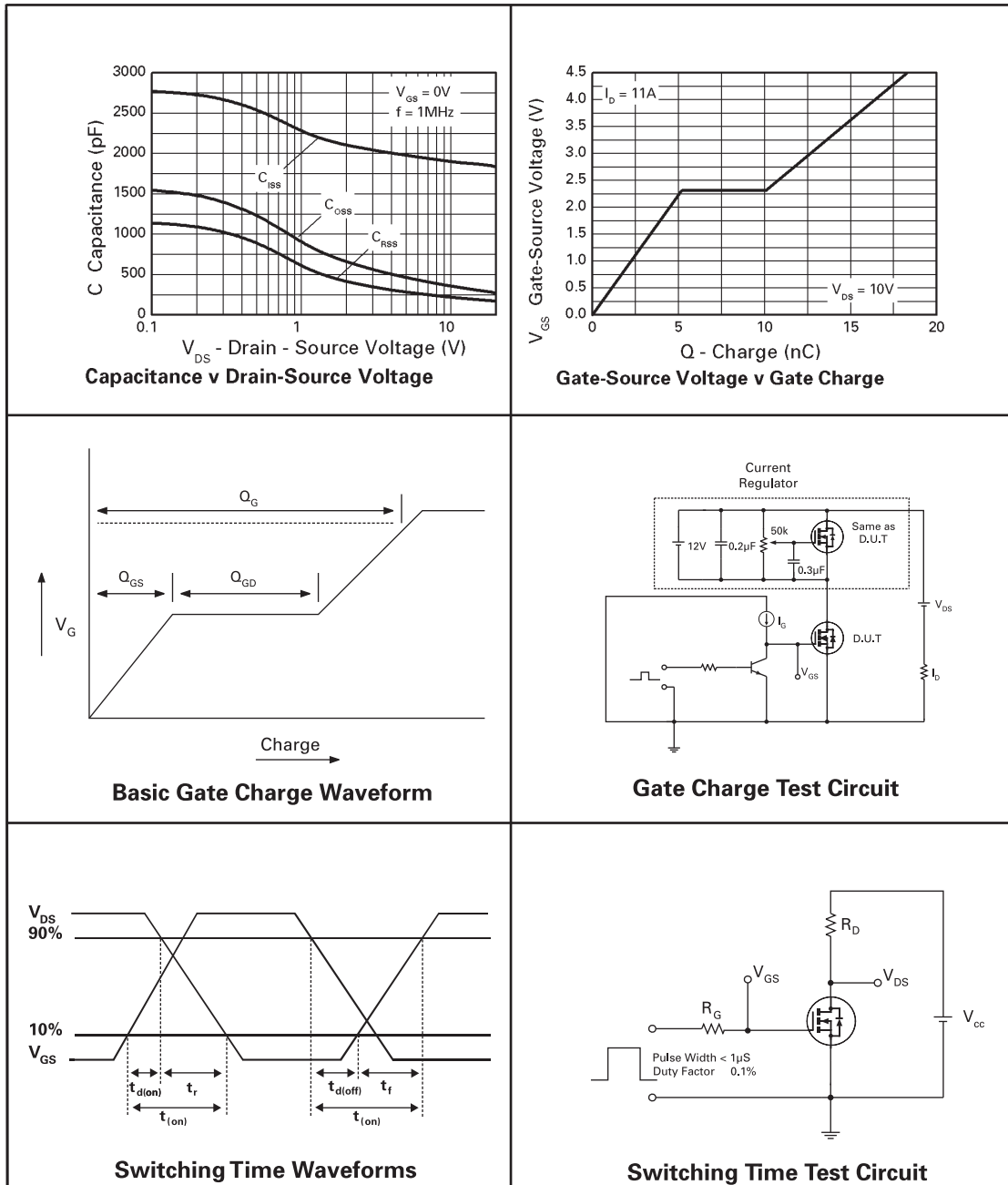

ZXMN2A02N8

Definitions

Product change

Zetex Semiconductors reserves the right to alter, without notice, specifications, design, price or conditions of supply of any product or service. Customers are solely responsible for obtaining the latest relevant information before placing orders.

Applications disclaimer

The circuits in this design/application note are offered as design ideas. It is the responsibility of the user to ensure that the circuit is fit for the user's application and meets with the user's requirements. No representation or warranty is given and no liability whatsoever is assumed by Zetex with respect to the accuracy or use of such information, or infringement of patents or other intellectual property rights arising from such use or otherwise. Zetex does not assume any legal responsibility or will not be held legally liable (whether in contract, tort (including negligence), breach of statutory duty, restriction or otherwise) for any damages, loss of profit, business, contract, opportunity or consequential loss in the use of these circuit applications, under any circumstances.

Life support

Zetex products are specifically not authorized for use as critical components in life support devices or systems without the express written approval of the Chief Executive Officer of Zetex Semiconductors plc. As used herein:

A. Life support devices or systems are devices or systems which:

1. are intended to implant into the body
or
2. support or sustain life and whose failure to perform when properly used in accordance with instructions
for use provided in the labeling can be reasonably expected to result in significant injury to the user.

B. A critical component is any component in a life support device or system whose failure to perform can be reasonably expected to cause the failure of the life support device or to affect its safety or effectiveness.

Reproduction

The product specifications contained in this publication are issued to provide outline information only which (unless agreed by the company in writing) may not be used, applied or reproduced for any purpose or form part of any order or contract or be regarded as a representation relating to the products or services concerned.

Terms and Conditions

All products are sold subjects to Zetex' terms and conditions of sale, and this disclaimer (save in the event of a conflict between the two when the terms of the contract shall prevail) according to region, supplied at the time of order acknowledgement.

For the latest information on technology, delivery terms and conditions and prices, please contact your nearest Zetex sales office.

Quality of product

Zetex is an ISO 9001 and TS16949 certified semiconductor manufacturer.

To ensure quality of service and products we strongly advise the purchase of parts directly from Zetex Semiconductors or one of our regionally authorized distributors. For a complete listing of authorized distributors please visit: www.zetex.com/salesnetwork

Zetex Semiconductors does not warrant or accept any liability whatsoever in respect of any parts purchased through unauthorized sales channels.

ESD (Electrostatic discharge)

Semiconductor devices are susceptible to damage by ESD. Suitable precautions should be taken when handling and transporting devices. The possible damage to devices depends on the circumstances of the handling and transporting, and the nature of the device. The extent of damage can vary from immediate functional or parametric malfunction to degradation of function or performance in use over time. Devices suspected of being affected should be replaced.

Green compliance

Zetex Semiconductors is committed to environmental excellence in all aspects of its operations which includes meeting or exceeding regulatory requirements with respect to the use of hazardous substances. Numerous successful programs have been implemented to reduce the use of hazardous substances and/or emissions.

All Zetex components are compliant with the RoHS directive, and through this it is supporting its customers in their compliance with WEEE and ELV directives.

Product status key:

- "Preview"Future device intended for production at some point. Samples may be available
- "Active"Product status recommended for new designs
- "Last time buy (LTB)"Device will be discontinued and last time buy period and delivery is in effect
- "Not recommended for new designs"Device is still in production to support existing designs and production
- "Obsolete"Production has been discontinued

Datasheet status key:

- "Draft version" This term denotes a very early datasheet version and contains highly provisional information, which may change in any manner without notice.
- "Provisional version" This term denotes a pre-release datasheet. It provides a clear indication of anticipated performance. However, changes to the test conditions and specifications may occur, at any time and without notice.
- "Issue" This term denotes an issued datasheet containing finalized specifications. However, changes to specifications may occur, at any time and without notice.

ZXMN2A02N8

PACKAGE OUTLINE

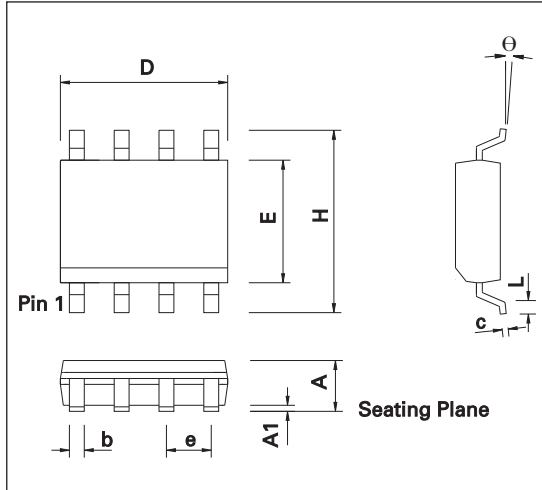

CONTROLLING DIMENSIONS ARE IN INCHES
APPROX IN MILLIMETERS

PACKAGE DIMENSIONS

DIM	INCHES		MILLIMETRES	
	MIN	MAX	MIN	MAX
A	0.053	0.069	1.35	1.75
A1	0.004	0.010	0.10	0.25
D	0.189	0.197	4.80	5.00
H	0.228	0.244	5.80	6.20
E	0.150	0.157	3.80	4.00
L	0.016	0.050	0.40	1.27
e	0.050 BSC		1.27 BSC	
b	0.013	0.020	0.33	0.51
c	0.008	0.010	0.19	0.25
θ	0°	8°	0°	8°
h	0.010	0.020	0.25	0.50

© Zetex Semiconductors plc 2007

Europe

Zetex GmbH
Kustermann-Park
Balanstraße 59
D-81541 München
Germany
Telefon: (49) 89 45 49 49 0
Fax: (49) 89 45 49 49 49
europa.sales@zetex.com

Americas

Zetex Inc
700 Veterans Memorial Hwy
Hauppauge, NY 11788
USA
Telephone: (1) 631 360 2222
Fax: (1) 631 360 8222
usa.sales@zetex.com

Asia Pacific

Zetex (Asia) Ltd
3701-04 Metroplaza Tower 1
Hing Fong Road, Kwai Fong
Hong Kong
Telephone: (852) 26100 611
Fax: (852) 24250 494
asia.sales@zetex.com

Corporate Headquarters

Zetex Semiconductors plc
Zetex Technology Park
Chadderton, Oldham, OL9 9LL
United Kingdom
Telephone (44) 161 622 4444
Fax: (44) 161 622 4446
hq@zetex.com



ISSUE 6 - FEBRUARY 2007

Mouser Electronics

Authorized Distributor

Click to View Pricing, Inventory, Delivery & Lifecycle Information:

[Diodes Incorporated:](#)

[ZXMN2A02N8TA](#)