

Power Amplifier, 8 W

5.2 - 5.9 GHz



MAAP-011027

Rev. V4

Features

- Linear Gain: 20 dB
- Saturated Output Power: 39 dBm Pulsed
- 50 Ω Input / Output Match
- Lead-Free 5 mm 20-lead PQFN Package
- RoHS* Compliant

Applications

- Point-to-Point Radios
- C-Band Radar

Description

The MAAP-011027 is a 2-stage, 8 W saturated C-band power amplifier in a 5 mm 20 lead PQFN package, allowing for easy assembly. This product is fully matched to 50 ohms on both the input and output. It can be used as a power amplifier stage or as a driver stage in high power pulsed applications.

Each device is 100% RF tested to ensure performance compliance.

Functional Schematic

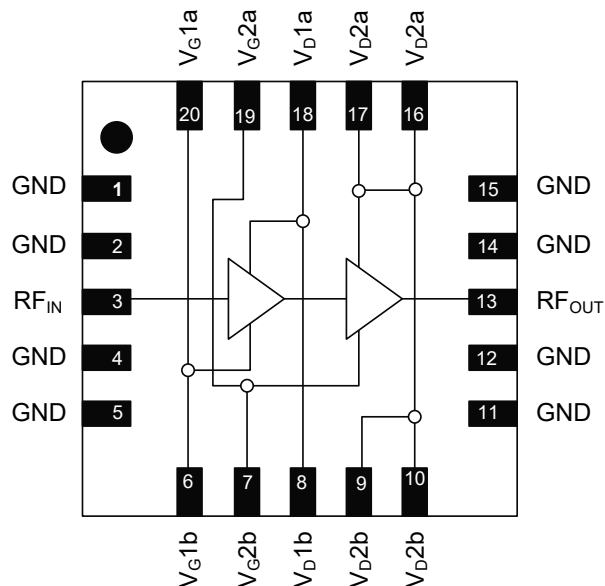

Pin Configuration²

Pin #	Function	Pin #	Function
1,2,4,5,11, 12,14,15,	Ground	13	RF _{OUT}
3	RF _{IN}	16,17	V _D 2a
6	V _G 1b	18	V _D 1a
7	V _G 2b	19	V _G 2a
8	V _D 1b	20	V _G 1a
9,10	V _D 2b	21	Paddle ³

Ordering Information¹

Part Number	Package
MAAP-011027-TR0500	500 piece reel
MAAP-011027-TR1000	1000 piece reel
MAAP-011027-000SMB	Sample Board

1. Reference Application Note M513 for reel size information.

2. MACOM recommends connecting unused package pins to ground.
3. The exposed pad centered on the package bottom must be connected to RF and DC ground.

* Restrictions on Hazardous Substances, compliant to current RoHS EU directive.

Power Amplifier, 8 W

5.2 - 5.9 GHz



MAAP-011027

Rev. V4

Electrical Specifications:

Freq. 5.2 - 5.9 GHz, $V_{DD} = 9\text{ V}$ Pulsed, 100 μs Pulse Width, 10% Duty Cycle, $Z_0 = 50\ \Omega$

Parameter	Units	Min.	Typ.	Max.
Gain	dB	17	20	—
Input Return Loss	dB	—	10	—
Output Return Loss	dB	—	10	—
P_{SAT}	dBm	37	39	—
Pulse Period	μs	—	100	—
Pulse Duty Cycle	%	—	10	—
Efficiency	%	—	37	—
Small Signal Current	A	—	1	—

Maximum Operating Ratings^{4,5,6}

Parameter	Absolute Maximum
Input Power	28 dBm
Supply Voltage	11 V
Junction Temperature ⁷	+150 °C
Operating Temperature	-40°C to +85°C
Storage Temperature	-55°C to +150°C

- Exceeding any one or combination of these limits may cause permanent damage to this device.
- MACOM does not recommend sustained operation near these survivability limits.
- Operating at nominal conditions with $T_J \leq +150^\circ\text{C}$ will ensure $MTTF > 1 \times 10^6$ hours.
- Junction Temperature (T_J) = $T_C + \Theta_{JC} * (V * I)$
Typical CW thermal resistance (Θ_{JC}) = 7.7°C/W

Handling Procedures

Please observe the following precautions to avoid damage:

Static Sensitivity

Gallium Arsenide Integrated Circuits are sensitive to electrostatic discharge (ESD) and can be damaged by static electricity. Proper ESD control techniques should be used when handling these class 1A devices.

Schematic

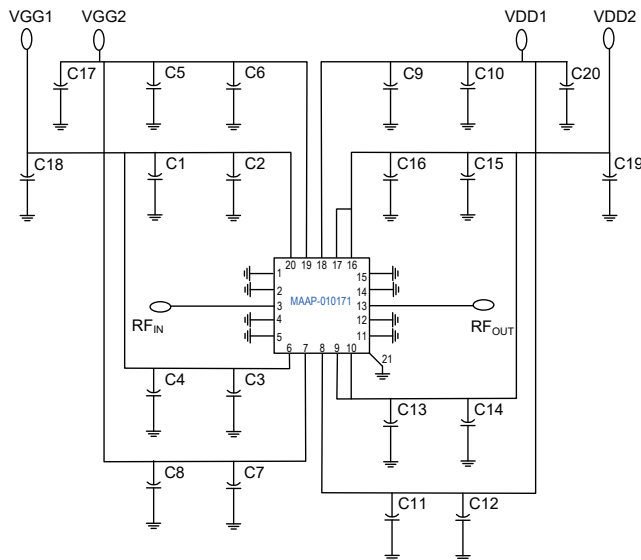

Recommended PCB Layout

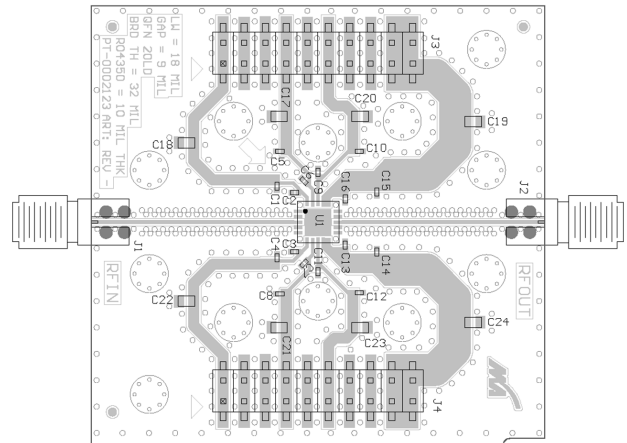

Parts List

Component	Value	Package
C2, C3, C5, C7, C9, C11, C13, C16	100 pF	0402
C1, C4, C6, C8, C10, C12, C14, C15	1000 pF	0402
C17, C18, C21, C22	1 μ F	0805
C19, C20, C23, C24	10 nF	0805

Operating the MAAP-011027

To operate the MAAP-011027, follow these steps. Ramp down or shut down in reverse order.

1. Apply V_G between -1 V and -0.5 V to set IDQ to 1 A
2. Apply RF Power ON
3. Apply V_{DD} Pulsed

Typical Performance Curves over Temperature

Gain

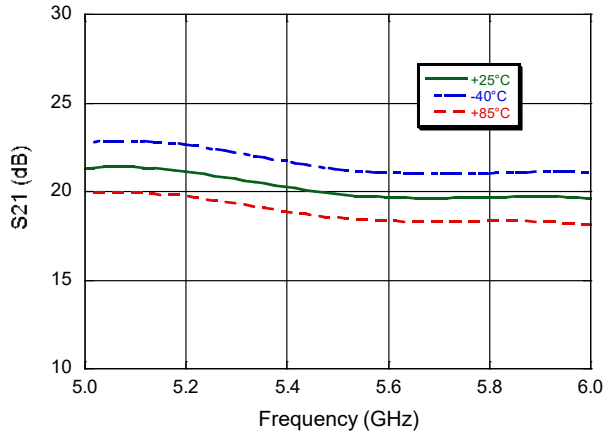

Reverse Isolation

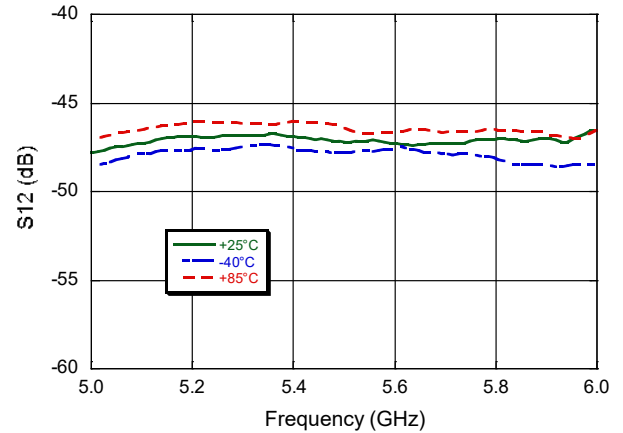

Input Return Loss

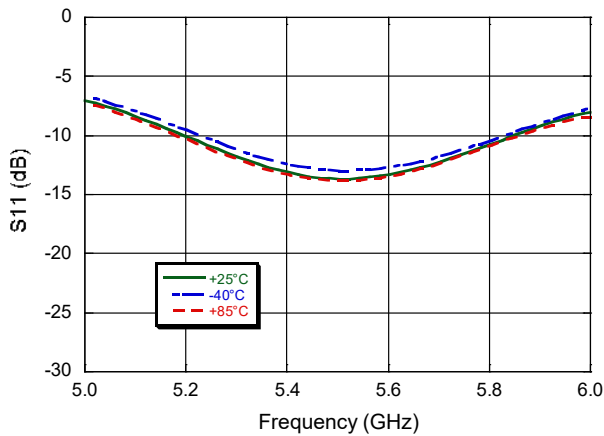

Output Return Loss

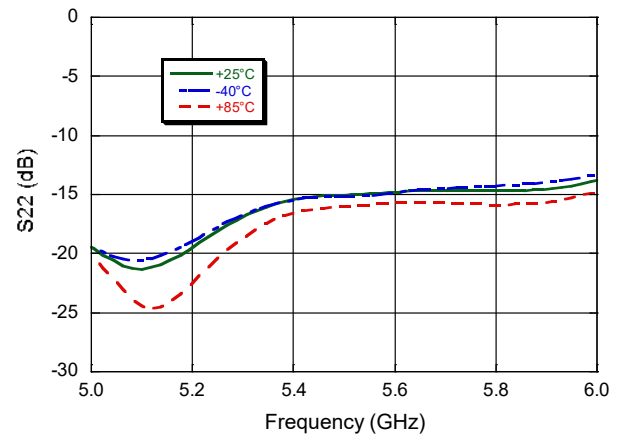

Output Power

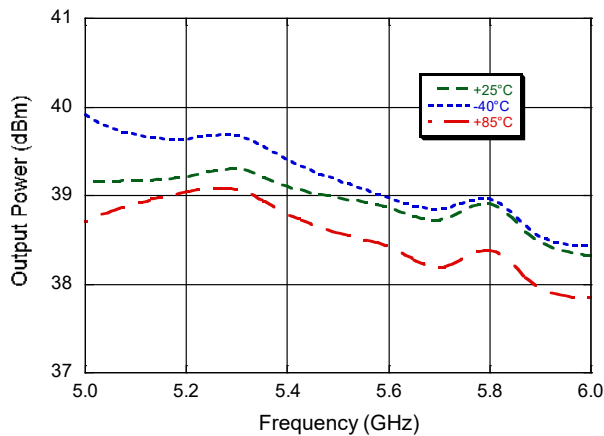

Power Added Efficiency

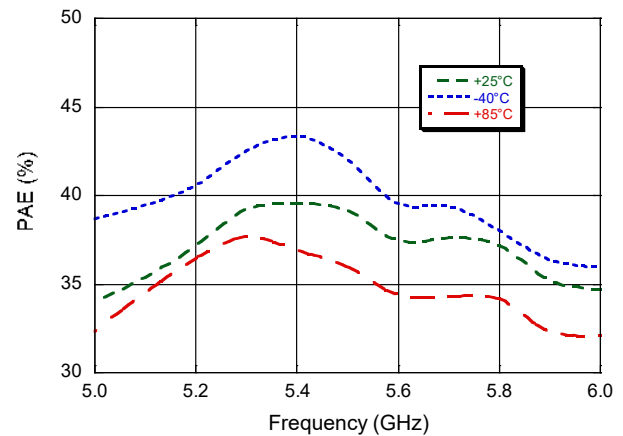

Typical Performance Curves over Voltage

Gain

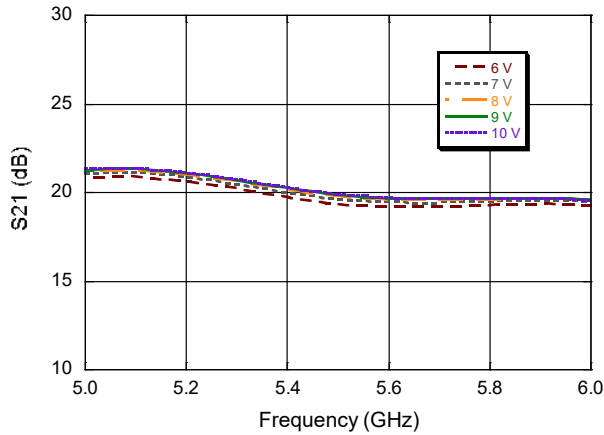

Reverse Isolation

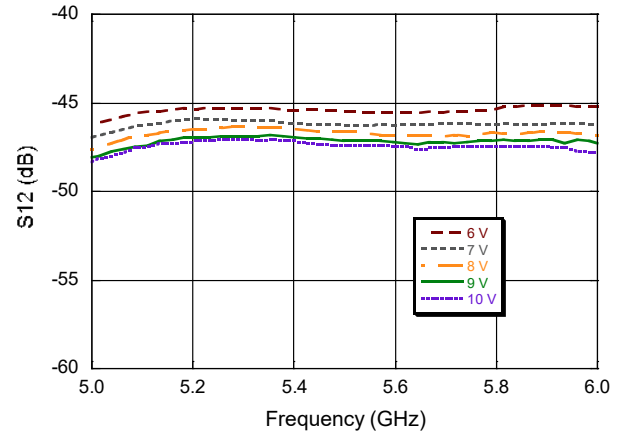

Input Return Loss

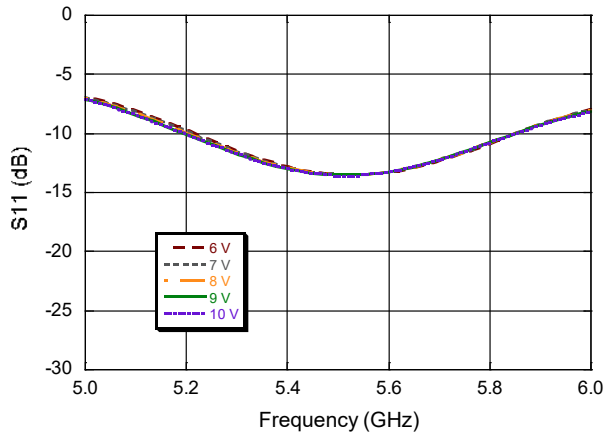

Output Return Loss

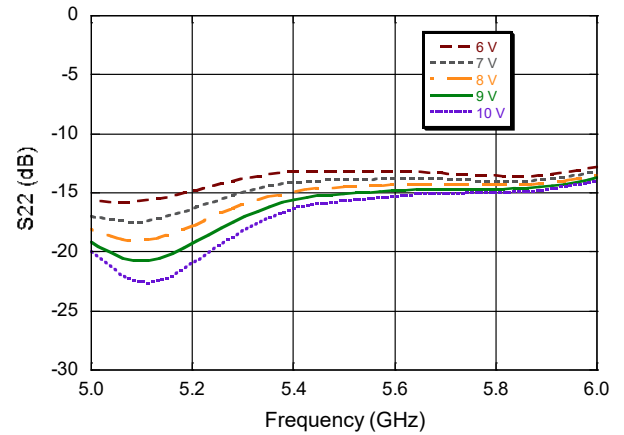

Output Power

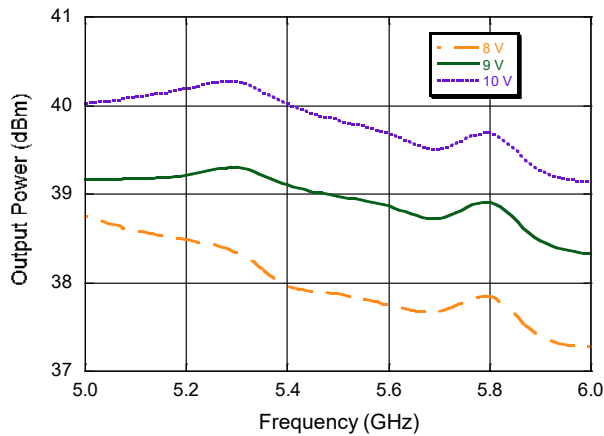

Power Added Efficiency

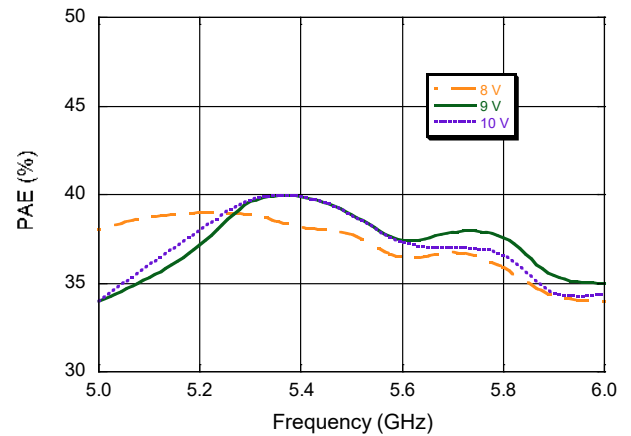

Typical Performance Curves

Power Gain vs. Input Power

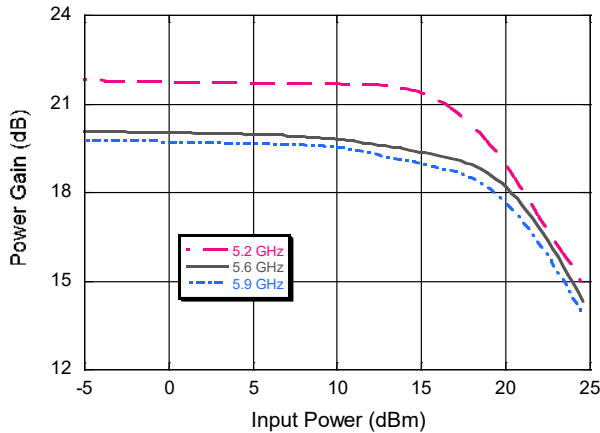

Power Added Efficiency vs. Output Power

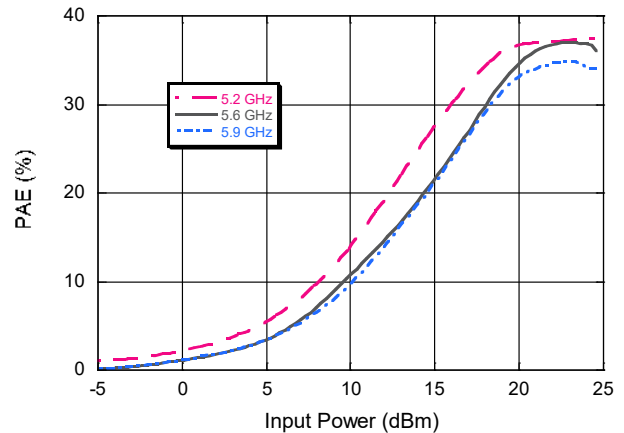

Power Gain vs. Input Power @ 5.6 GHz

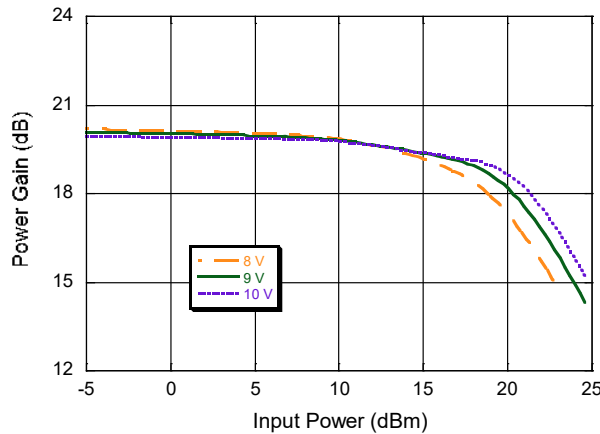

Power Added Efficiency vs. Input Power @ 5.6 GHz

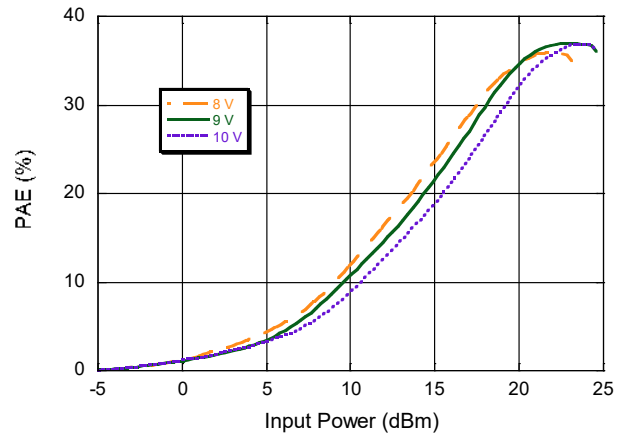

Power Gain vs. Input Power @ 5.6 GHz

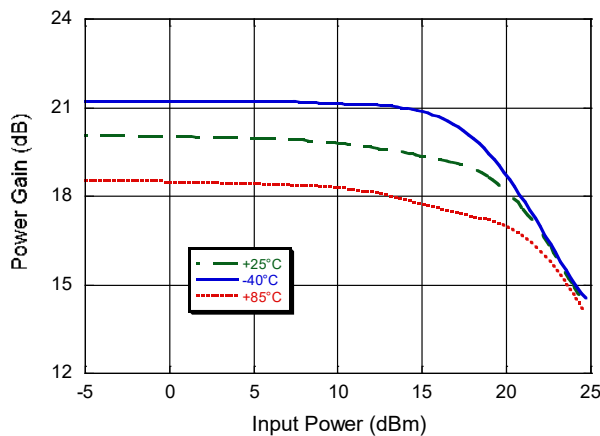

Power Added Efficiency vs. Input Power @ 5.6 GHz

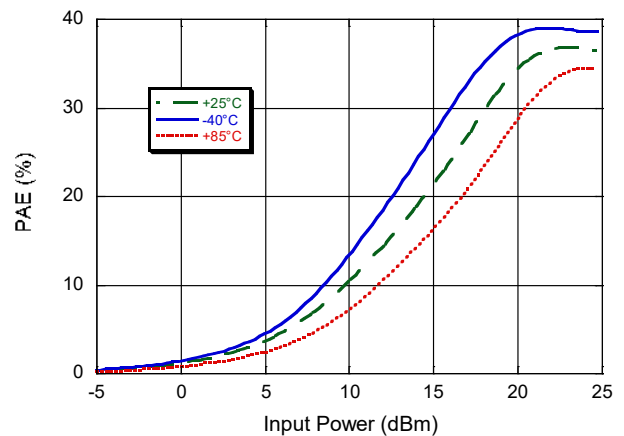

Typical Performance Curves

Small Signal wideband performance

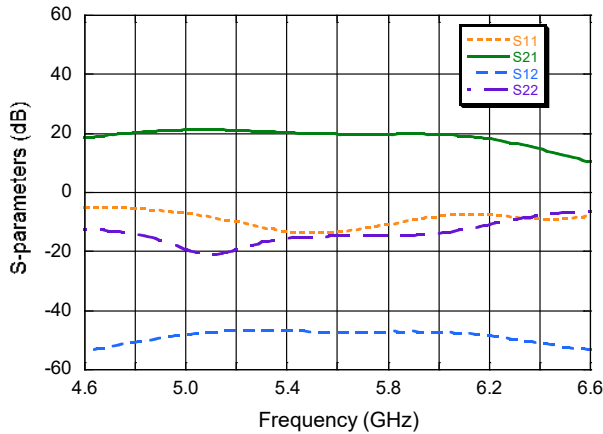

Drain Current vs. Input Power @ T = +25°C, F = 5.6 GHz

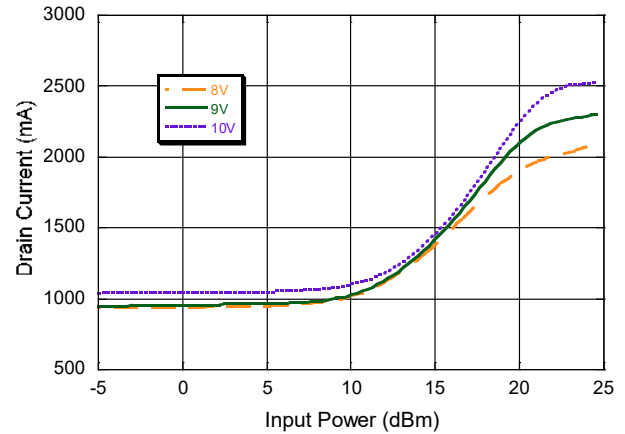

Power Dissipation⁸ vs. Case Temperature^{9,10}

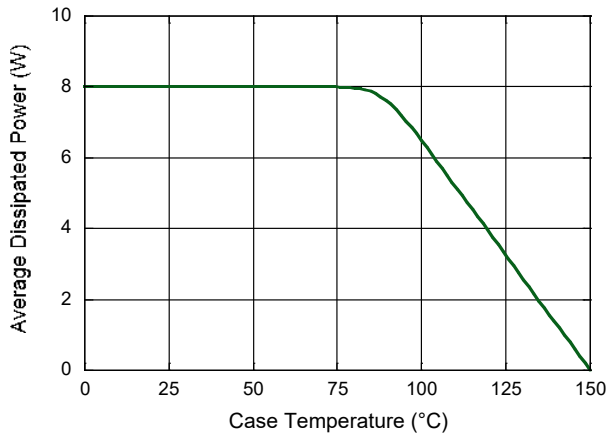

Drain Current vs. Input Power @ T = +25°C, V_D = 9 V

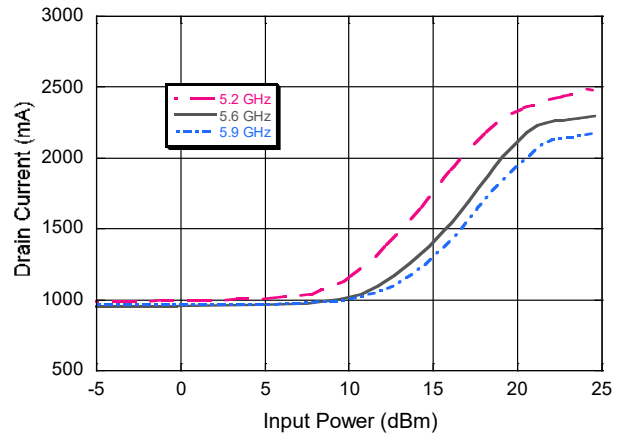

8. Average dissipated power: $P_{DISS} = P_{DC} + P_{IN} - P_{OUT}$ (all powers are average in Watts)
9. Average power is integrated over pulse period, for short pulses (not exceeding pulse width of 100 μ s), average power can be approximated as $P_{AVERAGE} = P_{PEAK} * D$, where D is duty cycle.
10. For pulses wider than 100 μ s self heating during pulse reduces allowable average dissipated power.

Drain Current vs. Input Power @ F = 5.6 GHz, V_D = 9 V

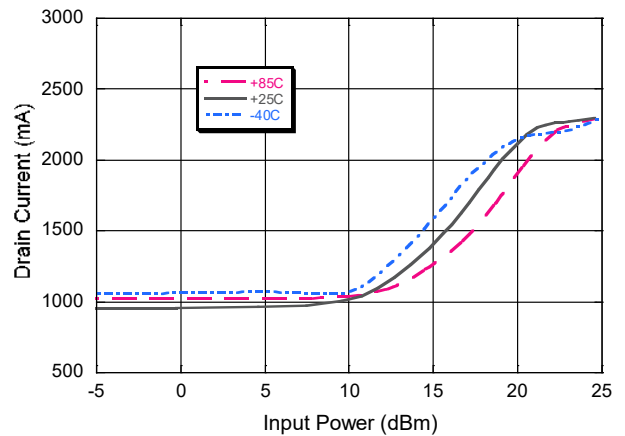

Power Amplifier, 8 W 5.2 - 5.9 GHz



MAAP-011027

Rev. V4

Lead-Free 5 mm 20-Lead PQFN†

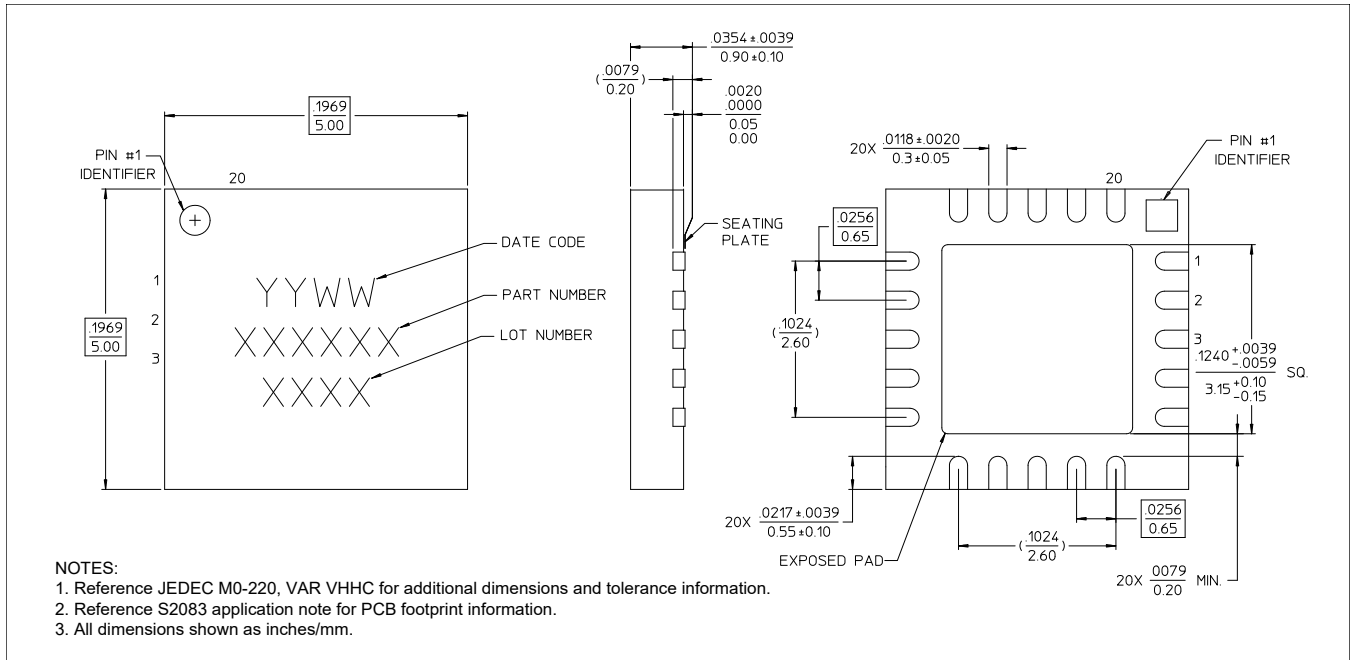

† Reference Application Note S2083 for lead-free solder reflow recommendations.
 Meets JEDEC moisture sensitivity level (MSL) 3 requirements.
 Plating is 100% matte tin over copper.

MACOM Technology Solutions Inc. All rights reserved.

Information in this document is provided in connection with MACOM Technology Solutions Inc ("MACOM") products. These materials are provided by MACOM as a service to its customers and may be used for informational purposes only. Except as provided in MACOM's Terms and Conditions of Sale for such products or in any separate agreement related to this document, MACOM assumes no liability whatsoever. MACOM assumes no responsibility for errors or omissions in these materials. MACOM may make changes to specifications and product descriptions at any time, without notice. MACOM makes no commitment to update the information and shall have no responsibility whatsoever for conflicts or incompatibilities arising from future changes to its specifications and product descriptions. No license, express or implied, by estoppel or otherwise, to any intellectual property rights is granted by this document.

THESE MATERIALS ARE PROVIDED "AS IS" WITHOUT WARRANTY OF ANY KIND, EITHER EXPRESS OR IMPLIED, RELATING TO SALE AND/OR USE OF MACOM PRODUCTS INCLUDING LIABILITY OR WARRANTIES RELATING TO FITNESS FOR A PARTICULAR PURPOSE, CONSEQUENTIAL OR INCIDENTAL DAMAGES, MERCHANTABILITY, OR INFRINGEMENT OF ANY PATENT, COPYRIGHT OR OTHER INTELLECTUAL PROPERTY RIGHT. MACOM FURTHER DOES NOT WARRANT THE ACCURACY OR COMPLETENESS OF THE INFORMATION, TEXT, GRAPHICS OR OTHER ITEMS CONTAINED WITHIN THESE MATERIALS. MACOM SHALL NOT BE LIABLE FOR ANY SPECIAL, INDIRECT, INCIDENTAL, OR CONSEQUENTIAL DAMAGES, INCLUDING WITHOUT LIMITATION, LOST REVENUES OR LOST PROFITS, WHICH MAY RESULT FROM THE USE OF THESE MATERIALS.

MACOM products are not intended for use in medical, lifesaving or life sustaining applications. MACOM customers using or selling MACOM products for use in such applications do so at their own risk and agree to fully indemnify MACOM for any damages resulting from such improper use or sale.