

6,000 V Surge breakdown voltage, 2 Form C, 2 A and High breakdown voltage type relays

TX-D RELAYS

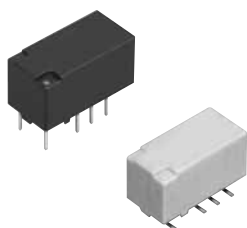

RoHS compliant

FEATURES

1. Approved to the supplementary insulation class in the EN standards (EN60950).

The insulation distance between the contact and coil meet the supplementary insulation class of the EN60950 standards as required for equipment connected to the telephone lines in Europe.

Satisfies the following conditions:

- Clearances: 2.0 mm .079 inch or more
- Creepage distance: 2.5 mm .098 inch or more

2. 3,000 V breakdown voltage between contact and coil.

3. Nominal operating power: High sensitivity of 200mW

4. High contact capacity: 2 A 30 V DC

5. High contact reliability

High contact reliability is achieved by the use of gold-clad twin crossbar contacts, low-gas formation materials, mold sealing the coil section, and by controlling organic gas in the coil.

***We also offer a range of products with AgPd contacts suitable for use in low level load analog circuits (Max. 10V DC 10 mA).**

TYPICAL APPLICATIONS

1. Facsimile
2. Modem
3. Communications (xDSL)
4. Medical equipment
5. Security

ORDERING INFORMATION

TXD **2** - - - - -

Contact arrangement
2: 2 Form C

Surface-mount availability
Nil: Standard PC board terminal
SA: SA type

Operating function
Nil: Single side stable L: 1 coil latching

Type of operation
Nil: Standard type
2M: M.B.B. type

Nominal coil voltage (DC)
3, 4.5, 5, 6, 9, 12, 24V

Contact material
Nil: Standard contact (Ag+Au clad)
1: AgPd contact (low level load); AgPd+Au clad (stationary), AgPd (movable)

Packing style
Nil: Tube packing
X: Tape and reel (picked from 1/3/4/5-pin side)
Z: Tape and reel packing (Picked from the 8/9/10/12-pin side)

Note: In case of 5 V transistor drive circuit, it is recommended to use 4.5 V type relay.

TYPES

1. Standard (B.B.M.) type

1) Standard PC board terminal

Contact arrangement	Nominal coil voltage	Single side stable	1 coil latching
		Part No.	Part No.
2 Form C	3 V DC	TXD2-3V	TXD2-L-3V
	4.5 V DC	TXD2-4.5V	TXD2-L-4.5V
	5 V DC	TXD2-5V	TXD2-L-5V
	6 V DC	TXD2-6V	TXD2-L-6V
	9 V DC	TXD2-9V	TXD2-L-9V
	12 V DC	TXD2-12V	TXD2-L-12V
	24 V DC	TXD2-24V	TXD2-L-24V

Standard packing: Tube: 40 pcs.; Case: 1,000 pcs.

Note: Please add "-1" to the end of the part number for AgPd contacts (low level load).

2) Surface-mount terminal

(1) Tube packing

Contact arrangement	Nominal coil voltage	Single side stable	1 coil latching
		Part No.	Part No.
2 Form C	3 V DC	TXD2SA-3V	TXD2SA-L-3V
	4.5 V DC	TXD2SA-4.5V	TXD2SA-L-4.5V
	5 V DC	TXD2SA-5V	TXD2SA-L-5V
	6 V DC	TXD2SA-6V	TXD2SA-L-6V
	9 V DC	TXD2SA-9V	TXD2SA-L-9V
	12 V DC	TXD2SA-12V	TXD2SA-L-12V
	24 V DC	TXD2SA-24V	TXD2SA-L-24V

Standard packing: Tube: 40 pcs.; Case: 1,000 pcs.

Note: Please add "-1" to the end of the part number for AgPd contacts (low level load).

(2) Tape and reel packing

Contact arrangement	Nominal coil voltage	Single side stable	1 coil latching
		Part No.	Part No.
2 Form C	3 V DC	TXD2SA-3V-Z	TXD2SA-L-3V-Z
	4.5 V DC	TXD2SA-4.5V-Z	TXD2SA-L-4.5V-Z
	5 V DC	TXD2SA-5V-Z	TXD2SA-L-5V-Z
	6 V DC	TXD2SA-6V-Z	TXD2SA-L-6V-Z
	9 V DC	TXD2SA-9V-Z	TXD2SA-L-9V-Z
	12 V DC	TXD2SA-12V-Z	TXD2SA-L-12V-Z
	24 V DC	TXD2SA-24V-Z	TXD2SA-L-24V-Z

Standard packing: Tape and reel: 500 pcs.; Case: 1,000 pcs.

Notes: 1. Tape and reel packing symbol "-Z" is not marked on the relay. "X" type tape and reel packing (picked from 1/3/4/5-pin side) is also available.

2. Please add "-1" to the part number for AgPd contacts (low level load). (Ex. TXD2SA-3V-1-Z)

2. M.B.B type

1) Standard PC board terminal

Contact arrangement	Nominal coil voltage	Single side stable
		Part No.
2 Form C	3 V DC	TXD2-2M-3V
	4.5 V DC	TXD2-2M-4.5V
	5 V DC	TXD2-2M-5V
	6 V DC	TXD2-2M-6V
	9 V DC	TXD2-2M-9V
	12 V DC	TXD2-2M-12V
	24 V DC	TXD2-2M-24V

Standard packing: Tube: 40 pcs.; Case: 1,000 pcs.

2) Surface-mount terminal

(1) Tube packing

Contact arrangement	Nominal coil voltage	Single side stable
		Part No.
2 Form C	3 V DC	TXD2SA-2M-3V
	4.5 V DC	TXD2SA-2M-4.5V
	5 V DC	TXD2SA-2M-5V
	6 V DC	TXD2SA-2M-6V
	9 V DC	TXD2SA-2M-9V
	12 V DC	TXD2SA-2M-12V
	24 V DC	TXD2SA-2M-24V

Standard packing: Tube: 40 pcs.; Case: 1,000 pcs.

(2) Tape and reel packing

Contact arrangement	Nominal coil voltage	Single side stable
		Part No.
2 Form C	3 V DC	TXD2SA-2M-3V-Z
	4.5 V DC	TXD2SA-2M-4.5V-Z
	5 V DC	TXD2SA-2M-5V-Z
	6 V DC	TXD2SA-2M-6V-Z
	9 V DC	TXD2SA-2M-9V-Z
	12 V DC	TXD2SA-2M-12V-Z
	24 V DC	TXD2SA-2M-24V-Z

Standard packing: Tape and reel: 500 pcs.; Case: 1,000 pcs.

Notes: 1. Types designed to withstand strong vibration caused, for example, by the use of terminal cutters, can also be ordered.

However, please contact us if you need parts for use in low level load. (Ex. TXD2SA-2M-3V-1-Z)

2. Tape and reel packing symbol "-Z" is not marked on the relay. "X" type tape and reel packing (picked from 1/3/4/5-pin side) is also available.

RATING

1. Coil data

[Standard (B.B.M.) type]

1) Single side stable

Nominal coil voltage	Pick-up voltage (at 20°C 68°F)	Drop-out voltage (at 20°C 68°F)	Nominal operating current [±10%] (at 20°C 68°F)	Coil resistance [±10%] (at 20°C 68°F)	Nominal operating power	Max. applied voltage (at 20°C 68°F)
3 V DC	75%V or less of nominal voltage* (Initial)	10%V or more of nominal voltage* (Initial)	66.7 mA	45 Ω	200 mW	120%V of nominal voltage
4.5 V DC			44.4 mA	101 Ω		
5 V DC			40.0 mA	125 Ω		
6 V DC			33.3 mA	180 Ω		
9 V DC			22.2 mA	405 Ω		
12 V DC			16.7 mA	720 Ω		
24 V DC			9.6 mA	2,504 Ω	230 mW	

2) 1 coil latching

Nominal coil voltage	Set voltage (at 20°C 68°F)	Reset voltage (at 20°C 68°F)	Nominal operating current [±10%] (at 20°C 68°F)	Coil resistance [±10%] (at 20°C 68°F)	Nominal operating power	Max. applied voltage (at 20°C 68°F)
3 V DC	75%V or less of nominal voltage* (Initial)	75%V or less of nominal voltage* (Initial)	50.0 mA	60 Ω	150 mW	120%V of nominal voltage
4.5 V DC			33.3 mA	135 Ω		
5 V DC			30.0 mA	166 Ω		
6 V DC			25.0 mA	240 Ω		
9 V DC			16.7 mA	540 Ω		
12 V DC			12.5 mA	960 Ω		
24 V DC			7.1 mA	3,388 Ω	170 mW	

[M.B.B. type]

Nominal coil voltage	Pick-up voltage (at 20°C 68°F)	Drop-out voltage (at 20°C 68°F)	Nominal operating current [±10%] (at 20°C 68°F)	Coil resistance [±10%] (at 20°C 68°F)	Nominal operating power	Max. applied voltage (at 20°C 68°F)
3 V DC	75%V or less of nominal voltage* (Initial)	10%V or more of nominal voltage* (Initial)	83.3 mA	36 Ω	250 mW	120%V of nominal voltage
4.5 V DC			55.6 mA	81 Ω		
5 V DC			50.0 mA	100 Ω		
6 V DC			41.7 mA	144 Ω		
9 V DC			27.8 mA	324 Ω		
12 V DC			20.8 mA	576 Ω		
24 V DC			11.3 mA	2,133 Ω	270 mW	

*Pulse drive (JIS C 5442-1986)

2. Specifications

Characteristics	Item	Specifications		
Contact	Arrangement	2 Form C	2 Form D (M.B.B.type)	
	Contact resistance (Initial)	Max. 100 mΩ (By voltage drop 6 V DC 1A)		
	Contact material	Standard contact: Ag+Au clad, AgPd contact (low level load): AgPd+Au clad (stationary), AgPd (movable)		
Rating	Nominal switching capacity	Standard contact: 2 A 30 V DC, AgPd contact: 1 A 30 V DC (resistive load)	1 A 30 V DC (resistive load)	
	Max. switching power	Standard contact: 60 W (DC), AgPd contact: 30 W (DC) (resistive load)	30 W (DC) (resistive load)	
	Max. switching voltage	220 V DC		
	Max. switching current	Standard contact: 2 A, AgPd contact: 1 A	1 A	
	Min. switching capacity (Reference value)*1	10μA10mV DC		
	Nominal operating power	Single side stable	200mW (3 to 12 V DC), 230mW (24 V DC)	250mW (1.5 to 12 V DC), 270mW (24 V DC)
1 coil latching		150mW (3 to 12 V DC), 170mW (24 V DC)	—	
Electrical characteristics	Insulation resistance (Initial)	Min. 1,000MΩ (at 500V DC) Measurement at same location as "Initial breakdown voltage" section.		
	Breakdown voltage (Initial)	Between open contacts	1,000 Vrms for 1min. (Detection current: 10mA)	500 Vrms for 1min. (Detection current: 10mA)
		Between contact and coil	3,000 Vrms for 1min. (Detection current: 10mA)	3,000 Vrms for 1min. (Detection current: 10mA)
		Between contact sets	1,000 Vrms for 1min. (Detection current: 10mA)	
	Surge breakdown voltage (Initial)	Between open contacts	1,500 V (10×160μs) (FCC Part 68)	
		Between contacts and coil*1	6,000 V, 1.2 × 50μs	
	Temperature rise (at 20°C 68°F)	Max. 50°C 122°F (By resistive method, nominal coil voltage applied to the coil; contact carrying current: 2A [1A: M.B.B.])		
Operate time [Set time] (at 20°C 68°F)	Max. 4 ms [Max. 4 ms] (Nominal coil voltage applied to the coil, excluding contact bounce time.)			
Release time [Reset time] (at 20°C 68°F)	Max. 4 ms [Max. 4 ms] (Nominal coil voltage applied to the coil, excluding contact bounce time.) (without diode)			
Mechanical characteristics	Shock resistance	Functional	Min. 750 m/s ² (Half-wave pulse of sine wave: 6 ms; detection time: 10μs.)	Min. 500 m/s ² (Half-wave pulse of sine wave: 11 ms; detection time: 10μs.)
		Destructive	Min. 1,000 m/s ² {100G} (Half-wave pulse of sine wave: 6 ms.)	
	Vibration resistance	Functional	10 to 55 Hz at double amplitude of 3.3 mm (Detection time: 10μs.)	
		Destructive	10 to 55 Hz at double amplitude of 5 mm	
Expected life	Mechanical	Min. 10 ⁸ (at 180 cpm)	Min. 10 ⁷ (at 180 cpm)	
	Electrical (Standard contact)	Min. 10 ⁵ (2 A 30 V DC resistive), Min. 5×10 ⁵ (1 A 30 V DC resistive) (at 20 cpm)	Min. 10 ⁵ (1 A 30 V DC resistive) (at 20 cpm)	
Conditions	Conditions for operation, transport and storage*2	Ambient temperature: -40°C to +85°C -40°F to +185°F; Humidity: 5 to 85% R.H. (Not freezing and condensing at low temperature)		
	Max. operating speed (at rated load)	20 cpm		
Unit weight	Approx. 2 g .071 oz			

Notes: *1 This value can change due to the switching frequency, environmental conditions, and desired reliability level, therefore it is recommended to check this with the actual load. AgPd contact type is available for low level load switching (10V DC, 10mA max. level).

*2 The upper operation ambient temperature limit is the maximum temperature that can satisfy the coil temperature rise value. Refer to "AMBIENT ENVIRONMENT" in GENERAL APPLICATION GUIDELINES.

REFERENCE DATA

1. Maximum switching capacity

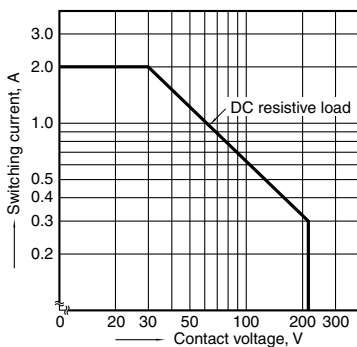

2. Life curve

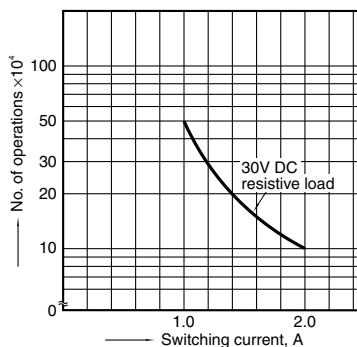

3. Mechanical life

Tested sample: TXD2-5V, 10 pcs.
Operating speed: 180 cpm

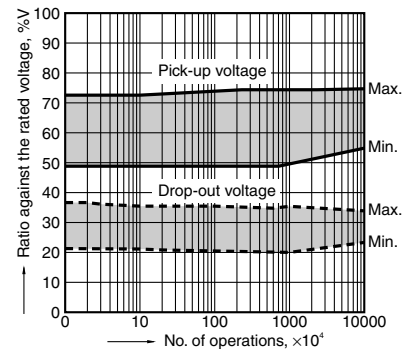

4. Electrical life (2 A 30 V DC resistive load)
 Tested sample: TXD2-5V, 6 pcs.
 Operating speed: 20 cpm
 Change of pick-up and drop-out voltage

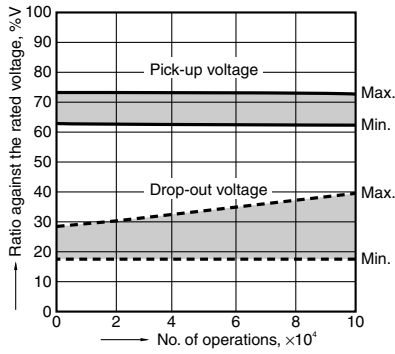

Change of contact resistance

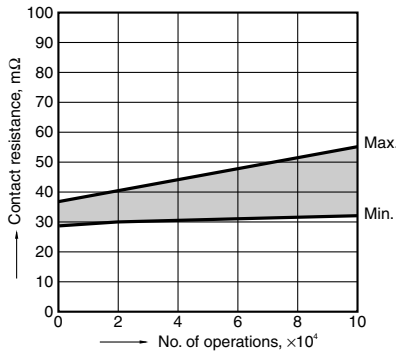

5-(1). Coil temperature rise
 Tested sample: TXD2-5V, 6 pcs.
 Measured portion: Inside the coil
 Ambient temperature: 25°C 77°F, 70°C 158°F

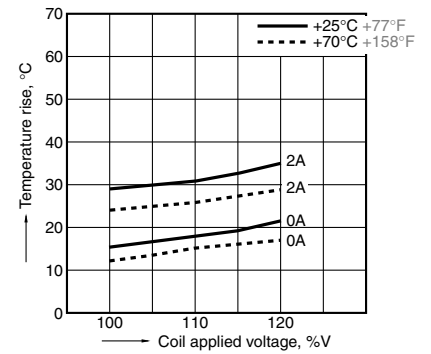

5-(2). Coil temperature rise
 Tested sample: TXD2-24V, 6 pcs.
 Measured portion: Inside the coil
 Ambient temperature: 25°C 77°F, 70°C 158°F

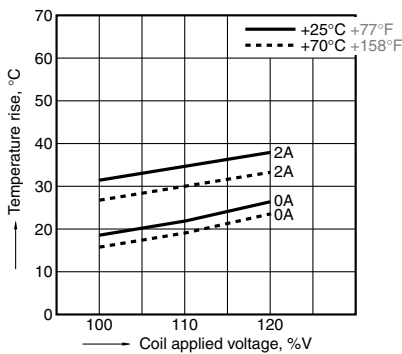

6-(1). Operate/release time characteristics (with diode)
 Tested sample: TXD2-5V, 10 pcs.

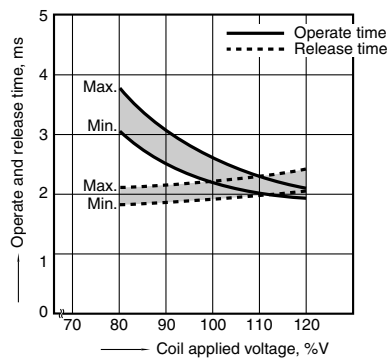

6-(2). Operate/release time characteristics (without diode)
 Tested sample: TXD2-5V, 10 pcs.

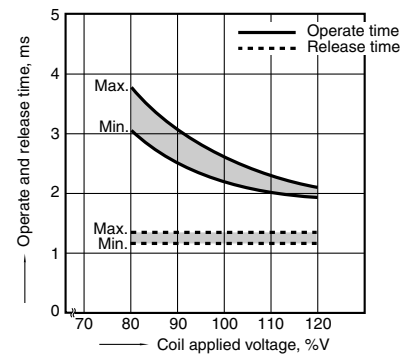

7. Ambient temperature characteristics
 Tested sample: TXD2-5V, 5 pcs.

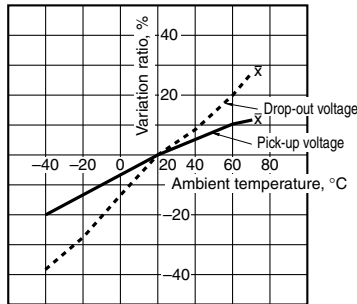

8. High-frequency characteristics (Isolation)
 Tested sample: TXD2-12V, 2 pcs.

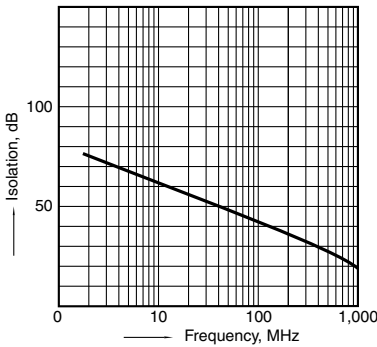

9. High-frequency characteristics (Insertion loss)
 Tested sample: TXD2-12V, 2 pcs.

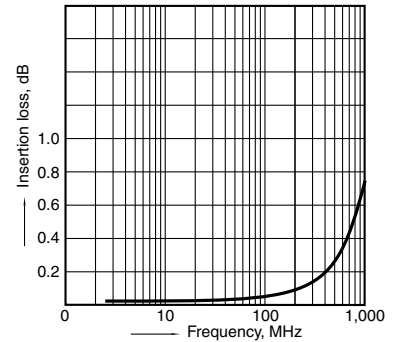

10. Malfunctional shock (single side stable)
 Tested sample: TXD2-5V, 6 pcs

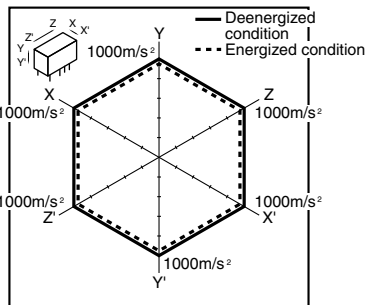

11-(1). Influence of adjacent mounting
 Tested sample: TXD2-12V, 6 pcs.

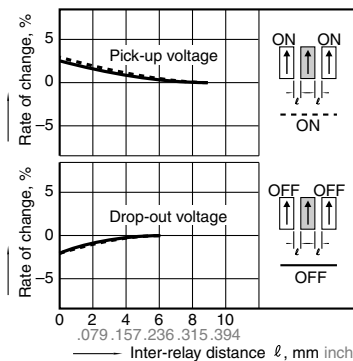

11-(2). Influence of adjacent mounting
 Tested sample: TXD2-12V, 6 pcs.

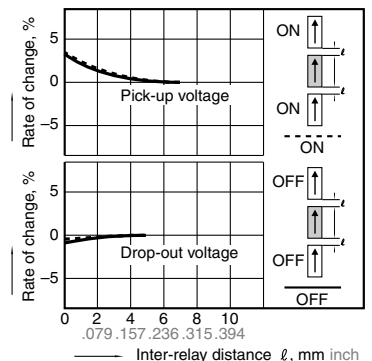

12. Actual load test (35 mA 48 V DC wire spring relay load)

Tested sample: TXD2-5V, 6 pcs.

Circuit

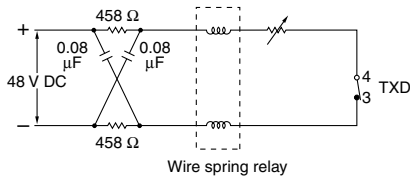

Change of pick-up and drop-out voltage

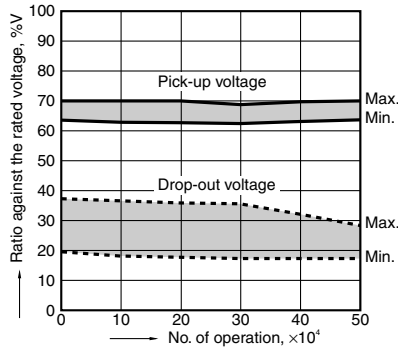

Change of contact resistance

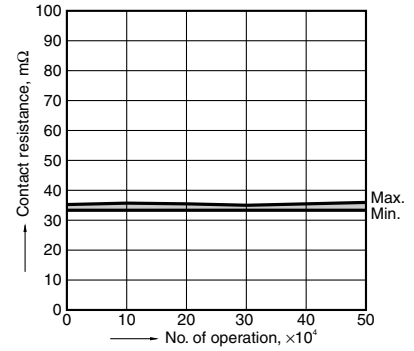

13-(1). Distribution of M.B.B. time

Tested sample: TXD2-2M-5V, 50 pcs.

Terminal No. 3-4-5: ON

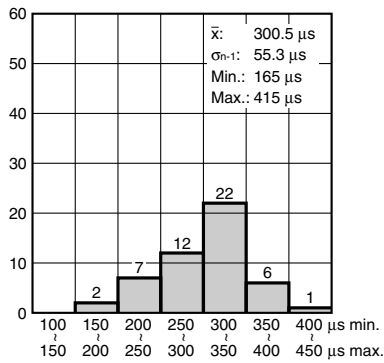

Terminal No. 3-4-5: OFF

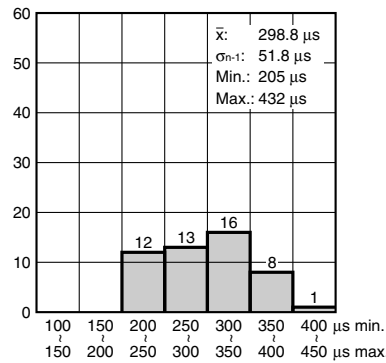

13-(2). Distribution of M.B.B. time

Tested sample: TXD2-2M-5V, 50 pcs.

Terminal No. 8-9-10: ON

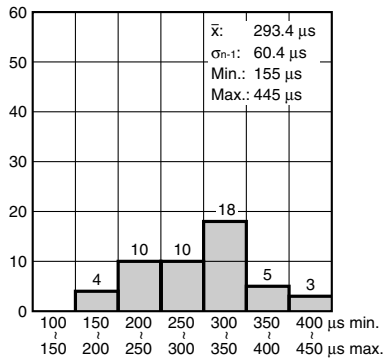

Terminal No. 8-9-10: OFF

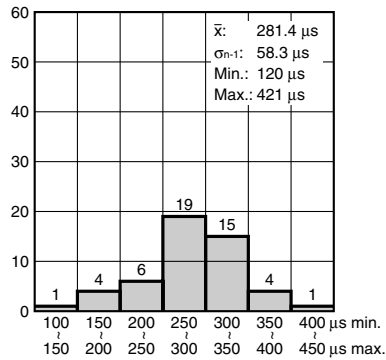

14. Surge breakdown voltage test

Tested sample: TXD2-3V, 30 pcs.

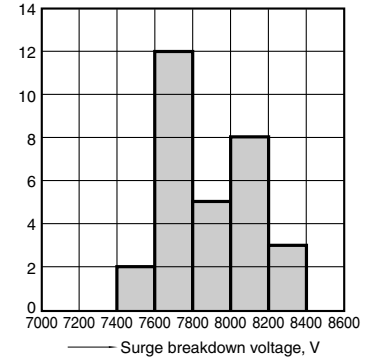

DIMENSIONS (mm inch)

The CAD data of the products with a **CAD Data** mark can be downloaded from: <http://industrial.panasonic.com/ac/e/>

1) Standard PC board terminal

CAD Data

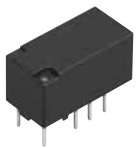

External dimensions
Standard PC board terminal

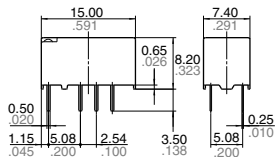

PC board pattern
(Bottom view)

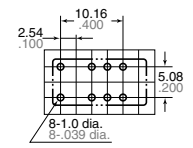

Tolerance: $\pm 0.1 \pm .004$

Schematic (Bottom view)

Single side stable

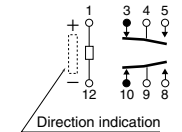

(Deenergized condition)

1 coil latching

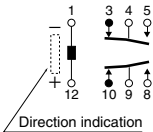

(Reset condition)

2) Surface-mount terminal

CAD Data



Type	External dimensions (General tolerance: $\pm 0.3 \pm 0.12$)	Suggested mounting pad (Top view) (Tolerance: $\pm 0.1 \pm 0.04$)
	Single side stable and 1 coil latching	Single side stable and 1 coil latching
SA type		

Schematic (Top view)

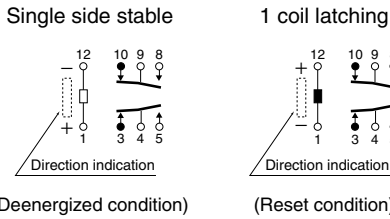

NOTES

1. Packing style

1) Tube packing
The relay is packed in a tube with the relay orientation mark on the left side, as shown in the figure below.

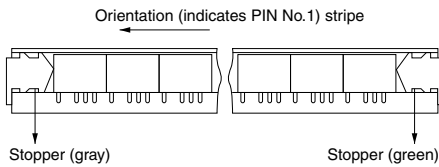

2) Tape and reel packing (surface-mount terminal type)

(1) Tape dimensions

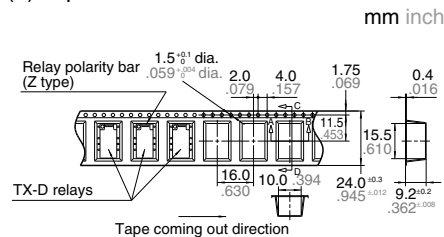

(2) Dimensions of plastic reel

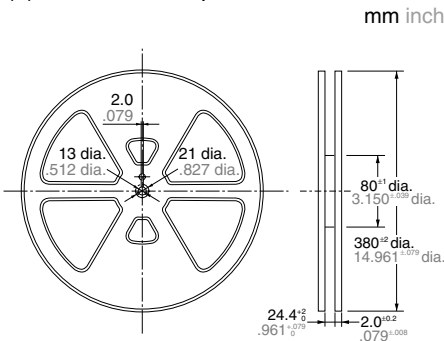

3) Ambient temperature when transporting and during storage with the product in its original packaging:
-40 to +70°C -40 to +158°F

2. Automatic insertion

To maintain the internal function of the relay, the chucking pressure should not exceed the values below.

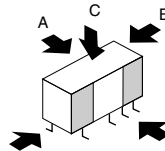

Chucking pressure in the direction A:
4.9 N {500gf} or less

Chucking pressure in the direction B:
9.8 N {1 kgf} or less

Chucking pressure in the direction C:
9.8 N {1 kgf} or less

Please chuck the portion. Avoid chucking the center of the relay. In addition, excessive chucking pressure to the pinpoint of the relay should be avoided.

3. M.B.B. type

A small OFF time may be generated by the contact bounce during contact switching. Check the actual circuit carefully.

If the relay is dropped accidentally, check the appearance and characteristics including M.B.B. time before use.

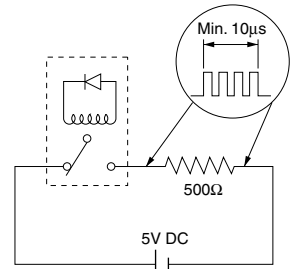

Measuring condition of M.B.B. time

For general cautions for use, please refer to the "Cautions for use of Signal Relays" or "General Application Guidelines".

Mouser Electronics

Authorized Distributor

Click to View Pricing, Inventory, Delivery & Lifecycle Information:

Panasonic:

[TXD2-5V](#) [TXD2SA-5V](#) [TXD2SA-5V-Z](#) [TXD2-12V](#) [TXD2SA-3V](#) [TXD2-24V](#) [TXD2SA-4.5V](#) [TXD2SS-3V-7](#) [TXD2SS-3V-6](#) [TXD2SA-12V-1-X](#) [TXD2SA-12V-1](#)