



30V, N-Channel NexFET™ Power MOSFETs

Check for Samples: [CSD17551Q5A](#)

FEATURES

- Ultra Low Qg and Qgd
- Low Thermal Resistance
- Avalanche Rated
- Pb Free Terminal Plating
- RoHS Compliant
- Halogen Free
- SON 5-mm x 6-mm Plastic Package

APPLICATIONS

- Point of load Synchronous Buck in Networking, Telecom and Computing Systems
- Optimized for Control FET Applications

DESCRIPTION

The NexFET power MOSFET has been designed to minimize losses in power conversion applications.

Figure 1. Top View

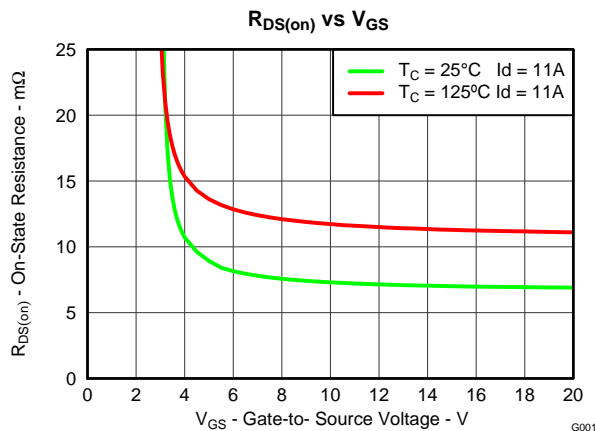
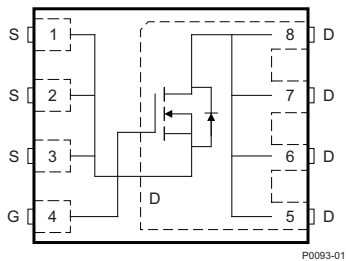

PRODUCT SUMMARY

V_{DS}	Drain to Source Voltage	30	V
Q_g	Gate Charge Total (4.5V)	6.0	nC
Q_{gd}	Gate Charge Gate to Drain	1.4	nC
$R_{DS(on)}$	Drain to Source On Resistance	$V_{GS} = 4.5V$	9 mΩ
		$V_{GS} = 10V$	7 mΩ
$V_{GS(th)}$	Threshold Voltage	1.7	V

ORDERING INFORMATION

Device	Package	Media	Qty	Ship
CSD17551Q5A	SON 5-mm x 6-mm Plastic Package	13-Inch Reel	2500	Tape and Reel

ABSOLUTE MAXIMUM RATINGS

$T_A = 25^\circ C$ unless otherwise stated		VALUE	UNIT
V_{DS}	Drain to Source Voltage	30	V
V_{GS}	Gate to Source Voltage	± 20	V
I_D	Continuous Drain Current, $T_C = 25^\circ C$	48	A
	Continuous Drain Current, $T_A = 25^\circ C^{(1)}$	13.5	A
I_{DM}	Pulsed Drain Current, $T_A = 25^\circ C^{(2)}$	85	A
P_D	Power Dissipation ⁽¹⁾	3	W
T_J, T_{STG}	Operating Junction and Storage Temperature Range	-55 to 150	$^\circ C$
E_{AS}	Avalanche Energy, single pulse $I_D = 25A, L = 0.1mH, R_G = 25\Omega$	31.3	mJ

(1) Typical $R_{\theta JA} = 41.9^\circ C/W$ on a 1-inch² (6.45-cm²), 2-oz. (0.071-mm thick) Cu pad on a 0.06-inch (1.52-mm) thick FR4 PCB.

(2) Pulse duration $\leq 300\mu s$, duty cycle $\leq 2\%$

GATE CHARGE

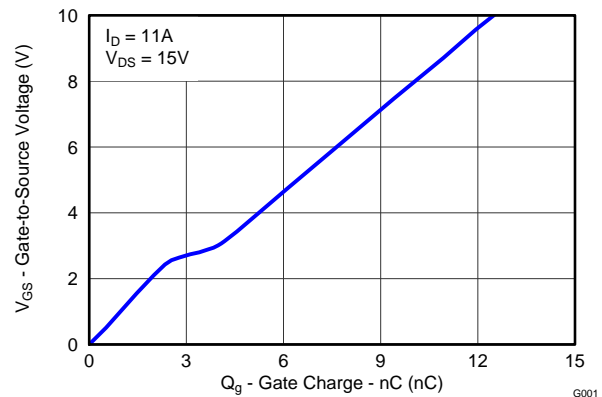

Please be aware that an important notice concerning availability, standard warranty, and use in critical applications of Texas Instruments semiconductor products and disclaimers thereto appears at the end of this data sheet.



These devices have limited built-in ESD protection. The leads should be shorted together or the device placed in conductive foam during storage or handling to prevent electrostatic damage to the MOS gates.

ELECTRICAL CHARACTERISTICS

($T_A = 25^\circ\text{C}$ unless otherwise stated)

PARAMETER		TEST CONDITIONS	MIN	TYP	MAX	UNIT
Static Characteristics						
V_{DSS}	Drain to Source Voltage	$V_{GS} = 0V, I_D = 250\mu A$	30			V
I_{DSS}	Drain to Source Leakage Current	$V_{GS} = 0V, V_{DS} = 24V$			1	μA
I_{GSS}	Gate to Source Leakage Current	$V_{DS} = 0V, V_{GS} = 20V$			100	nA
$V_{GS(th)}$	Gate to Source Threshold Voltage	$V_{DS} = V_{GS}, I_D = 250\mu A$	1.2	1.7	2.2	V
$R_{DS(on)}$	Drain to Source On Resistance	$V_{GS} = 4.5V, I_D = 11A$		9	11	$m\Omega$
		$V_{GS} = 10V, I_D = 11A$		7	8.8	$m\Omega$
g_{fs}	Transconductance	$V_{DS} = 15V, I_D = 11A$		107		S
Dynamic Characteristics						
C_{iss}	Input Capacitance	$V_{GS} = 0V, V_{DS} = 15V, f = 1MHz$		1060	1272	pF
C_{oss}	Output Capacitance			247	296	pF
C_{riss}	Reverse Transfer Capacitance			19	24	pF
R_G	Series Gate Resistance			1.4	1.9	Ω
Q_g	Gate Charge Total (4.5V)	$V_{DS} = 15V, I_D = 11A$		6	7.2	nC
Q_{gd}	Gate Charge Gate to Drain			1.4		nC
Q_{gs}	Gate Charge Gate to Source			2.8		nC
$Q_{g(th)}$	Gate Charge at V_{th}			1.6		nC
Q_{oss}	Output Charge	$V_{DS} = 13V, V_{GS} = 0V$		7.2		nC
$t_{d(on)}$	Turn On Delay Time	$V_{DS} = 15V, V_{GS} = 4.5V,$ $I_{DS} = 11A, R_G = 2\Omega$		9.1		ns
t_r	Rise Time			15.5		ns
$t_{d(off)}$	Turn Off Delay Time			11.9		ns
t_f	Fall Time			4.3		ns
Diode Characteristics						
V_{SD}	Diode Forward Voltage	$I_{SD} = 11A, V_{GS} = 0V$		0.8	1	V
Q_{rr}	Reverse Recovery Charge	$V_{DS} = 13.5V, I_F = 11A,$ $di/dt = 300A/\mu s$		8.7		nC
t_{rr}	Reverse Recovery Time			13.5		ns

THERMAL CHARACTERISTICS

($T_A = 25^\circ\text{C}$ unless otherwise stated)

PARAMETER		MIN	TYP	MAX	UNIT
$R_{\theta JC}$	Thermal Resistance Junction to Case ⁽¹⁾			4.2	$^\circ\text{C/W}$
$R_{\theta JA}$	Thermal Resistance Junction to Ambient ⁽¹⁾⁽²⁾			52.3	$^\circ\text{C/W}$

- (1) $R_{\theta JC}$ is determined with the device mounted on a 1-inch² (6.45-cm²), 2-oz. (0.071-mm thick) Cu pad on a 1.5-inch x 1.5-inch (3.81-cm x 3.81-cm), 0.06-inch (1.52-mm) thick FR4 PCB. $R_{\theta JC}$ is specified by design, whereas $R_{\theta JA}$ is determined by the user's board design.
- (2) Device mounted on FR4 material with 1-inch² (6.45-cm²), 2-oz. (0.071-mm thick) Cu.

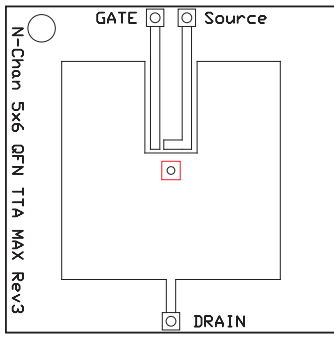

M0137-01

Max $R_{\theta JA} = 52.3^{\circ}\text{C/W}$
when mounted on
1 inch² (6.45 cm²) of 2-
oz. (0.071-mm thick)
Cu.

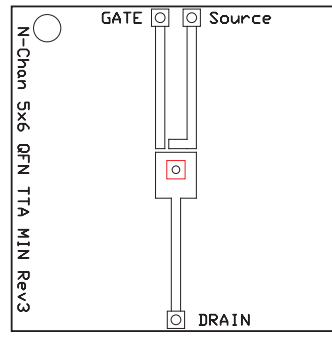

M0137-02

Max $R_{\theta JA} = 133^{\circ}\text{C/W}$
when mounted on a
minimum pad area of
2-oz. (0.071-mm thick)
Cu.

TYPICAL MOSFET CHARACTERISTICS

($T_A = 25^{\circ}\text{C}$ unless otherwise stated)

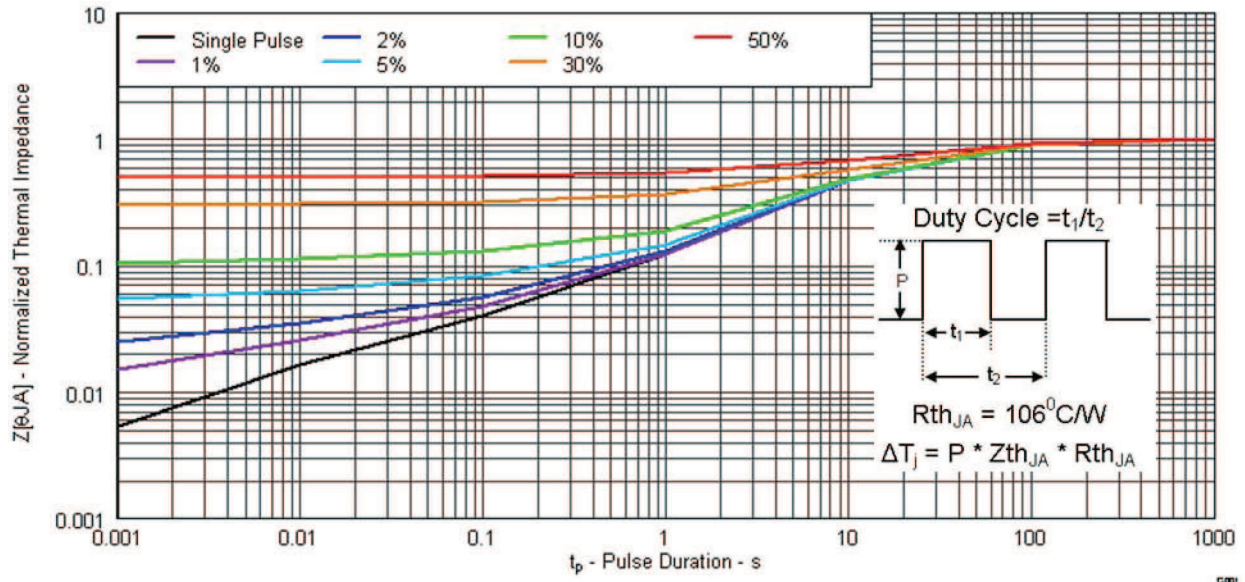

Figure 2. Transient Thermal Impedance

TYPICAL MOSFET CHARACTERISTICS (continued)

($T_A = 25^\circ\text{C}$ unless otherwise stated)

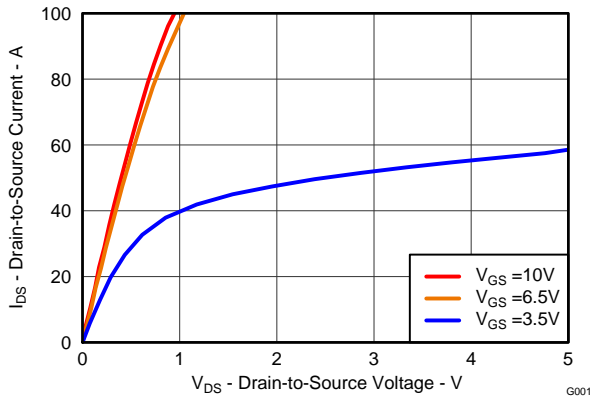

Figure 3. Saturation Characteristics

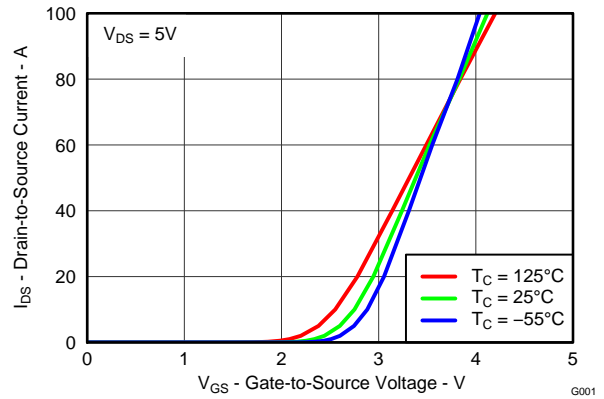

Figure 4. Transfer Characteristics

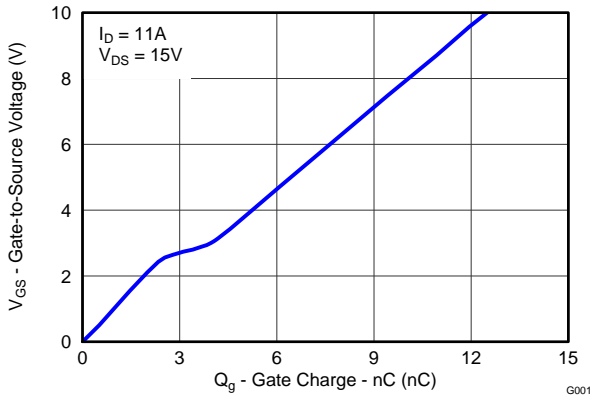

Figure 5. Gate Charge

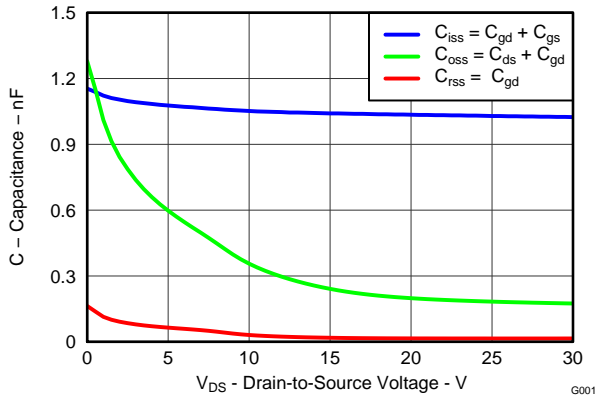

Figure 6. Capacitance

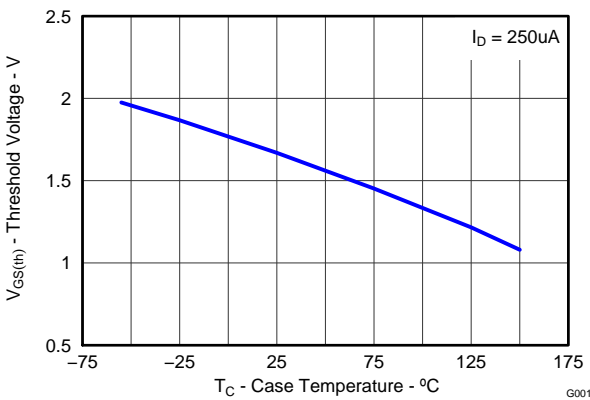

Figure 7. Threshold Voltage vs. Temperature

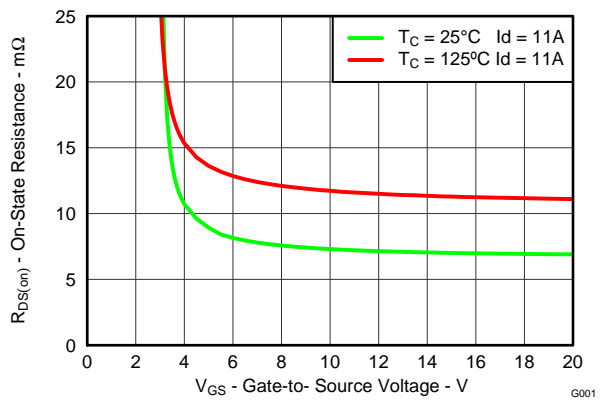

Figure 8. On-State Resistance vs. Gate-to-Source Voltage

TYPICAL MOSFET CHARACTERISTICS (continued)

($T_A = 25^\circ\text{C}$ unless otherwise stated)

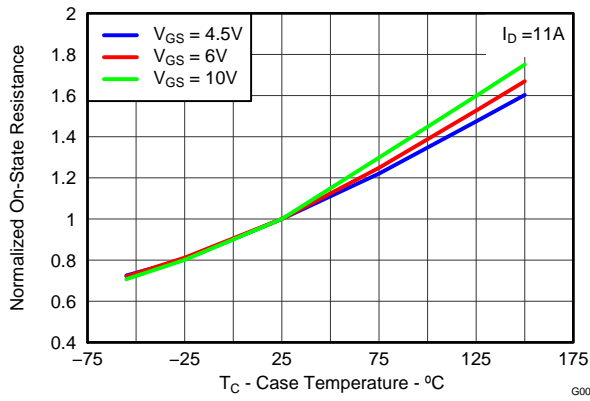

Figure 9. Normalized On-State Resistance vs. Temperature

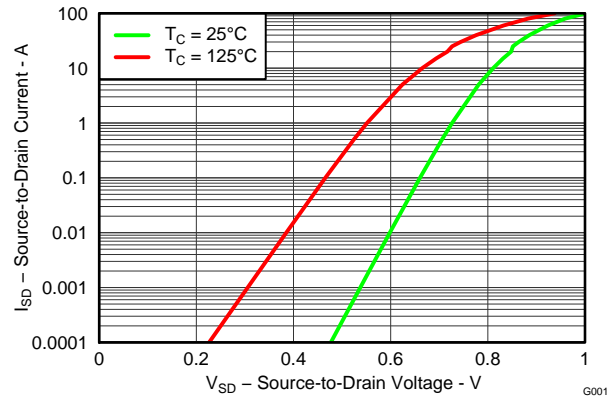

Figure 10. Typical Diode Forward Voltage

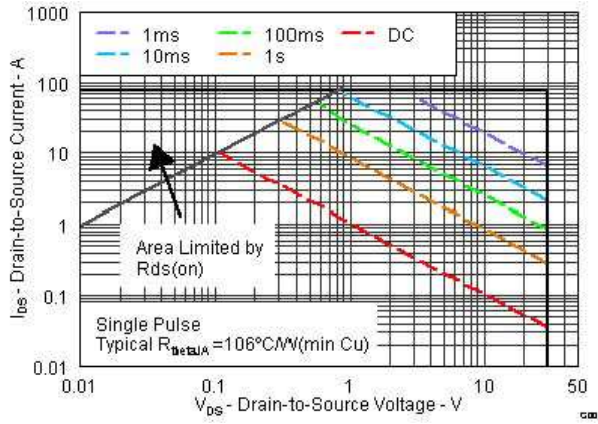

Figure 11. Maximum Safe Operating Area

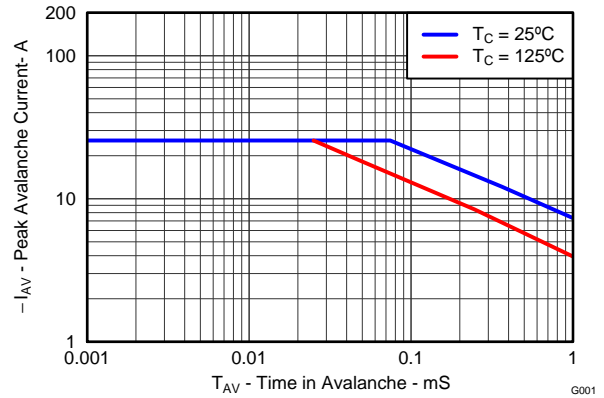

Figure 12. Single Pulse Unclamped Inductive Switching

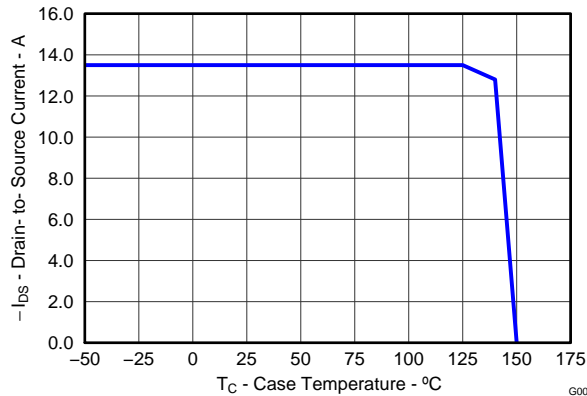

Figure 13. Maximum Drain Current vs. Temperature

MECHANICAL DATA

Q5A Package Dimensions



M0135-01

DIM	MILLIMETERS		
	MIN	NOM	MAX
A	0.90	1.00	1.10
b	0.33	0.41	0.51
c	0.20	0.25	0.34
D1	4.80	4.90	5.00
D2	3.61	3.81	4.02
E	5.90	6.00	6.10
E1	5.70	5.75	5.80
E2	3.38	3.58	3.78
e	1.17	1.27	1.37
H	0.41	0.56	0.71
K	1.10		
L	0.51	0.61	0.71
L1	0.06	0.13	0.20
θ	0°		12°

Figure 14. Recommended PCB Pattern

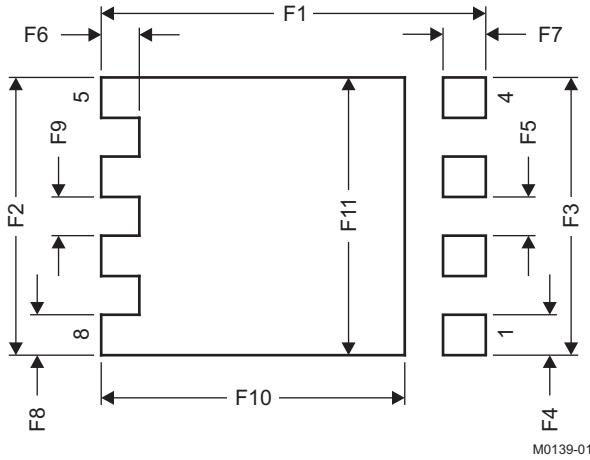

DIM	MILLIMETERS		INCHES	
	MIN	MAX	MIN	MAX
F1	6.205	6.305	0.244	0.248
F2	4.46	4.56	0.176	0.18
F3	4.46	4.56	0.176	0.18
F4	0.65	0.7	0.026	0.028
F5	0.62	0.67	0.024	0.026
F6	0.63	0.68	0.025	0.027
F7	0.7	0.8	0.028	0.031
F8	0.65	0.7	0.026	0.028
F9	0.62	0.67	0.024	0.026
F10	4.9	5	0.193	0.197
F11	4.46	4.56	0.176	0.18

For recommended circuit layout for PCB designs, see application note [SLPA005 – Reducing Ringing Through PCB Layout Techniques](#).

Q5A Tape and Reel Information

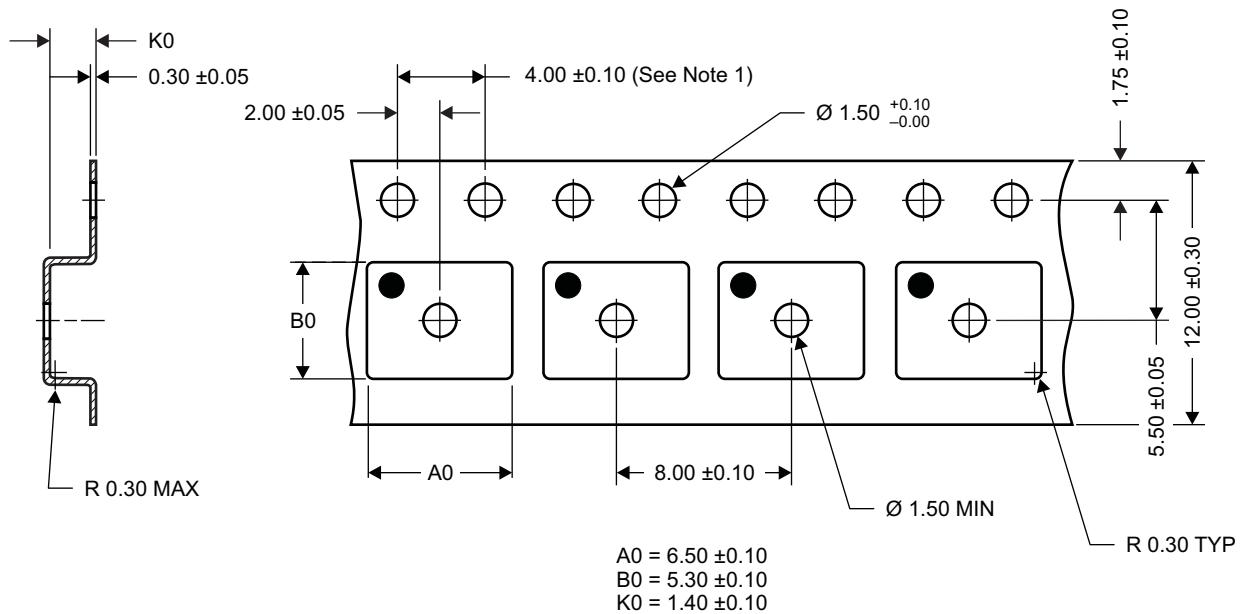

M0138-01

Notes:

- 10-sprocket hole-pitch cumulative tolerance ± 0.2
- Camber not to exceed 1mm in 100mm, noncumulative over 250mm
- Material: black static-dissipative polystyrene
- All dimensions are in mm (unless otherwise specified)
- A0 and B0 measured on a plane 0.3mm above the bottom of the pocket

PACKAGING INFORMATION

Orderable Device	Status (1)	Package Type	Package Drawing	Pins	Package Qty	Eco Plan (2)	Lead/Ball Finish (6)	MSL Peak Temp (3)	Op Temp (°C)	Device Marking (4/5)	Samples
CSD17551Q5A	ACTIVE	VSONP	DQJ	8	2500	Green (RoHS & no Sb/Br)	SN	Level-1-260C-UNLIM	-55 to 150	CSD17551	Samples

(1) The marketing status values are defined as follows:

ACTIVE: Product device recommended for new designs.

LIFEBUY: TI has announced that the device will be discontinued, and a lifetime-buy period is in effect.

NRND: Not recommended for new designs. Device is in production to support existing customers, but TI does not recommend using this part in a new design.

PREVIEW: Device has been announced but is not in production. Samples may or may not be available.

OBSOLETE: TI has discontinued the production of the device.

(2) **RoHS:** TI defines "RoHS" to mean semiconductor products that are compliant with the current EU RoHS requirements for all 10 RoHS substances, including the requirement that RoHS substance do not exceed 0.1% by weight in homogeneous materials. Where designed to be soldered at high temperatures, "RoHS" products are suitable for use in specified lead-free processes. TI may reference these types of products as "Pb-Free".

RoHS Exempt: TI defines "RoHS Exempt" to mean products that contain lead but are compliant with EU RoHS pursuant to a specific EU RoHS exemption.

Green: TI defines "Green" to mean the content of Chlorine (Cl) and Bromine (Br) based flame retardants meet JS709B low halogen requirements of <=1000ppm threshold. Antimony trioxide based flame retardants must also meet the <=1000ppm threshold requirement.

(3) MSL, Peak Temp. - The Moisture Sensitivity Level rating according to the JEDEC industry standard classifications, and peak solder temperature.

(4) There may be additional marking, which relates to the logo, the lot trace code information, or the environmental category on the device.

(5) Multiple Device Markings will be inside parentheses. Only one Device Marking contained in parentheses and separated by a "~" will appear on a device. If a line is indented then it is a continuation of the previous line and the two combined represent the entire Device Marking for that device.

(6) Lead/Ball Finish - Orderable Devices may have multiple material finish options. Finish options are separated by a vertical ruled line. Lead/Ball Finish values may wrap to two lines if the finish value exceeds the maximum column width.

Important Information and Disclaimer:The information provided on this page represents TI's knowledge and belief as of the date that it is provided. TI bases its knowledge and belief on information provided by third parties, and makes no representation or warranty as to the accuracy of such information. Efforts are underway to better integrate information from third parties. TI has taken and continues to take reasonable steps to provide representative and accurate information but may not have conducted destructive testing or chemical analysis on incoming materials and chemicals. TI and TI suppliers consider certain information to be proprietary, and thus CAS numbers and other limited information may not be available for release.

In no event shall TI's liability arising out of such information exceed the total purchase price of the TI part(s) at issue in this document sold by TI to Customer on an annual basis.

IMPORTANT NOTICE AND DISCLAIMER

TI PROVIDES TECHNICAL AND RELIABILITY DATA (INCLUDING DATASHEETS), DESIGN RESOURCES (INCLUDING REFERENCE DESIGNS), APPLICATION OR OTHER DESIGN ADVICE, WEB TOOLS, SAFETY INFORMATION, AND OTHER RESOURCES "AS IS" AND WITH ALL FAULTS, AND DISCLAIMS ALL WARRANTIES, EXPRESS AND IMPLIED, INCLUDING WITHOUT LIMITATION ANY IMPLIED WARRANTIES OF MERCHANTABILITY, FITNESS FOR A PARTICULAR PURPOSE OR NON-INFRINGEMENT OF THIRD PARTY INTELLECTUAL PROPERTY RIGHTS.

These resources are intended for skilled developers designing with TI products. You are solely responsible for (1) selecting the appropriate TI products for your application, (2) designing, validating and testing your application, and (3) ensuring your application meets applicable standards, and any other safety, security, or other requirements. These resources are subject to change without notice. TI grants you permission to use these resources only for development of an application that uses the TI products described in the resource. Other reproduction and display of these resources is prohibited. No license is granted to any other TI intellectual property right or to any third party intellectual property right. TI disclaims responsibility for, and you will fully indemnify TI and its representatives against, any claims, damages, costs, losses, and liabilities arising out of your use of these resources.

TI's products are provided subject to TI's Terms of Sale (www.ti.com/legal/termsofsale.html) or other applicable terms available either on ti.com or provided in conjunction with such TI products. TI's provision of these resources does not expand or otherwise alter TI's applicable warranties or warranty disclaimers for TI products.

Mailing Address: Texas Instruments, Post Office Box 655303, Dallas, Texas 75265
Copyright © 2020, Texas Instruments Incorporated