

CDBB340-HF Thru. CDBB3100-HF

Reverse Voltage: 40 to 100 Volts

Forward Current: 3.0 Amp

RoHS Device

Halogen Free

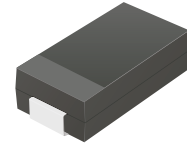

Features

- Low Profile surface mount applications in order to optimize board space.
- Low power loss, high efficiency.
- High current capability, low forward voltage drop.
- High surge capability.
- Guard ring for overvoltage protection.
- Ultra high-speed switching.
- Silicon epitaxial planar chip, metal silicon junction.

Mechanical data

- Epoxy: UL94-V0 rate flame retardant.
- Case: Molded plastic, DO-214AA / SMB
- Terminals: Solderable per MIL-STD-750, method 2026.
- Polarity: Indicated by cathode band.
- Weight: 0.091 grams

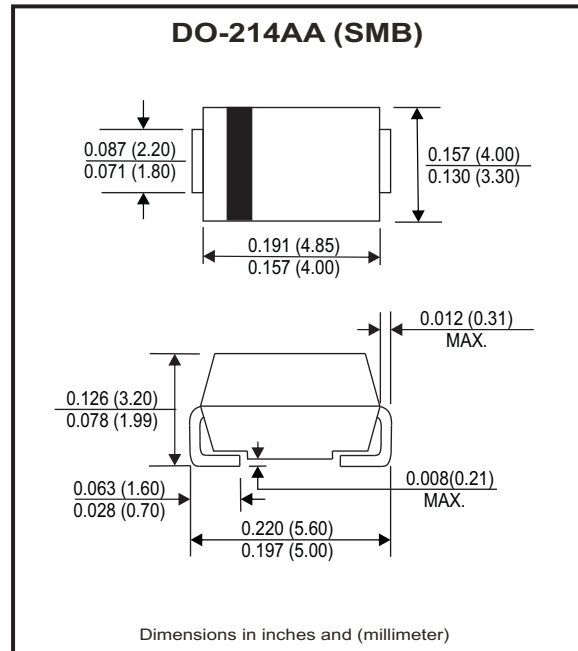

Circuit Diagram



Maximum Ratings and Electrical Characteristics

Ratings at Ta=25°C unless otherwise noted.
 Single phase, half wave, 60Hz, resistive or inductive loaded.
 For capacitive load, derate current by 20% .

Parameter	Symbol	CDBB 340-HF	CDBB 360-HF	CDBB 3100-HF	Unit
Max. repetitive peak reverse voltage	V _{RRM}	40	60	100	V
Max. DC blocking voltage	V _{DC}	40	60	100	V
Max. RMS voltage	V _{RMS}	28	42	70	V
Max. instantaneous forward voltage @ 3.0A, T _A =25°C	V _F	0.50	0.70	0.81	V
Operating temperature range	T _{op}	-40 to +70			°C
Junction temperature range	T _J	-50 to +150			°C
Storage temperature range	T _{STG}	-50 to +175			°C

Parameter	Conditions	Symbol	MIN.	TYP.	MAX.	Unit
Forward rectified current	see Fig.1	I _O			3.0	A
Forward surge current	8.3ms single half sine-wave superimposed on rate load (JEDEC method)	I _{FSM}			70	A
Reverse Current	V _R =V _{RRM} T _J =25°C	I _R			0.5	mA
	V _R =V _{RRM} T _J =100°C	I _R			20	mA
Thermal Resistance	Junction to ambient	R _{θJA}		55		°C/W
Diode Junction capacitance	f=1MHz and applied 4V DC reverse Voltage	C _J		250		pF

Company reserves the right to improve product design , functions and reliability without notice.

REV: E

RATING AND CHARACTERISTIC CURVES (CDBB340-HF thru. CDBB3100-HF)

Fig.1 - Typical Forward Current Derating Curve

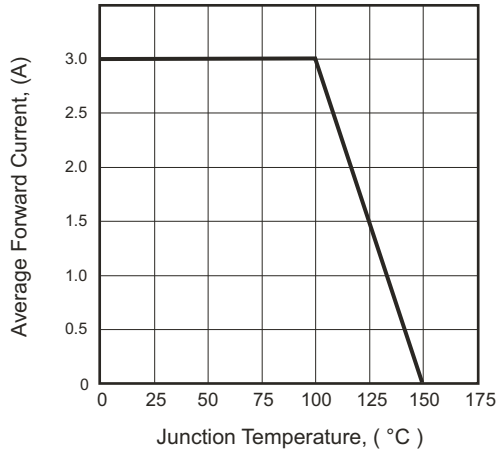

Fig.2 - Typical Forward Characteristics

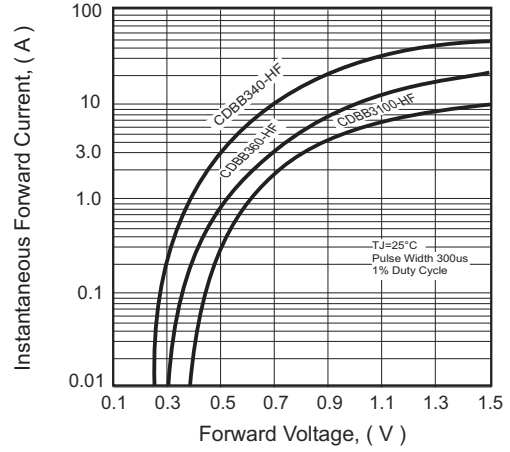

Fig.3 - Maximum Non-repetitive Forward Surge Current

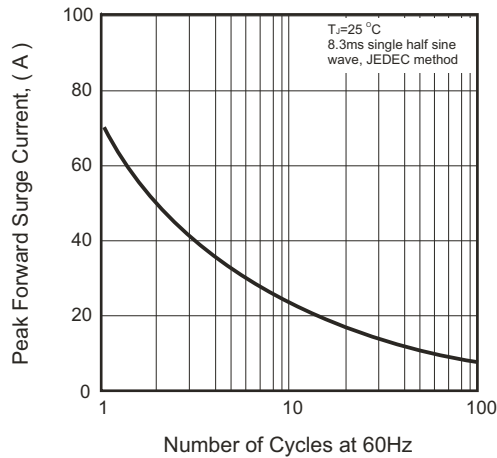

Fig.4 - Typical Junction Capacitance

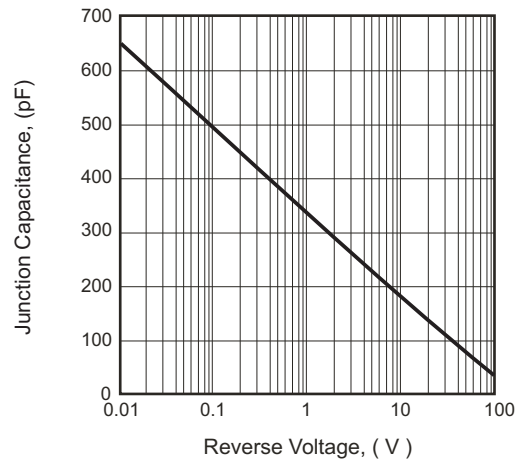
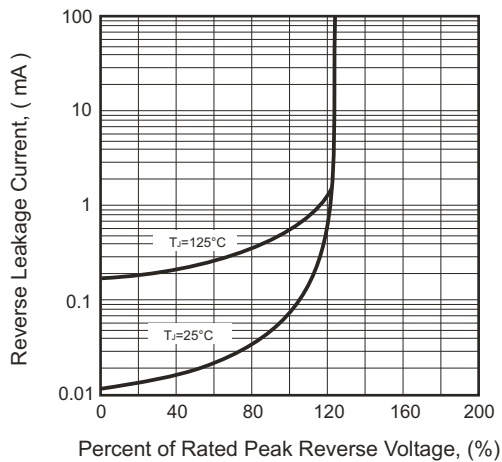
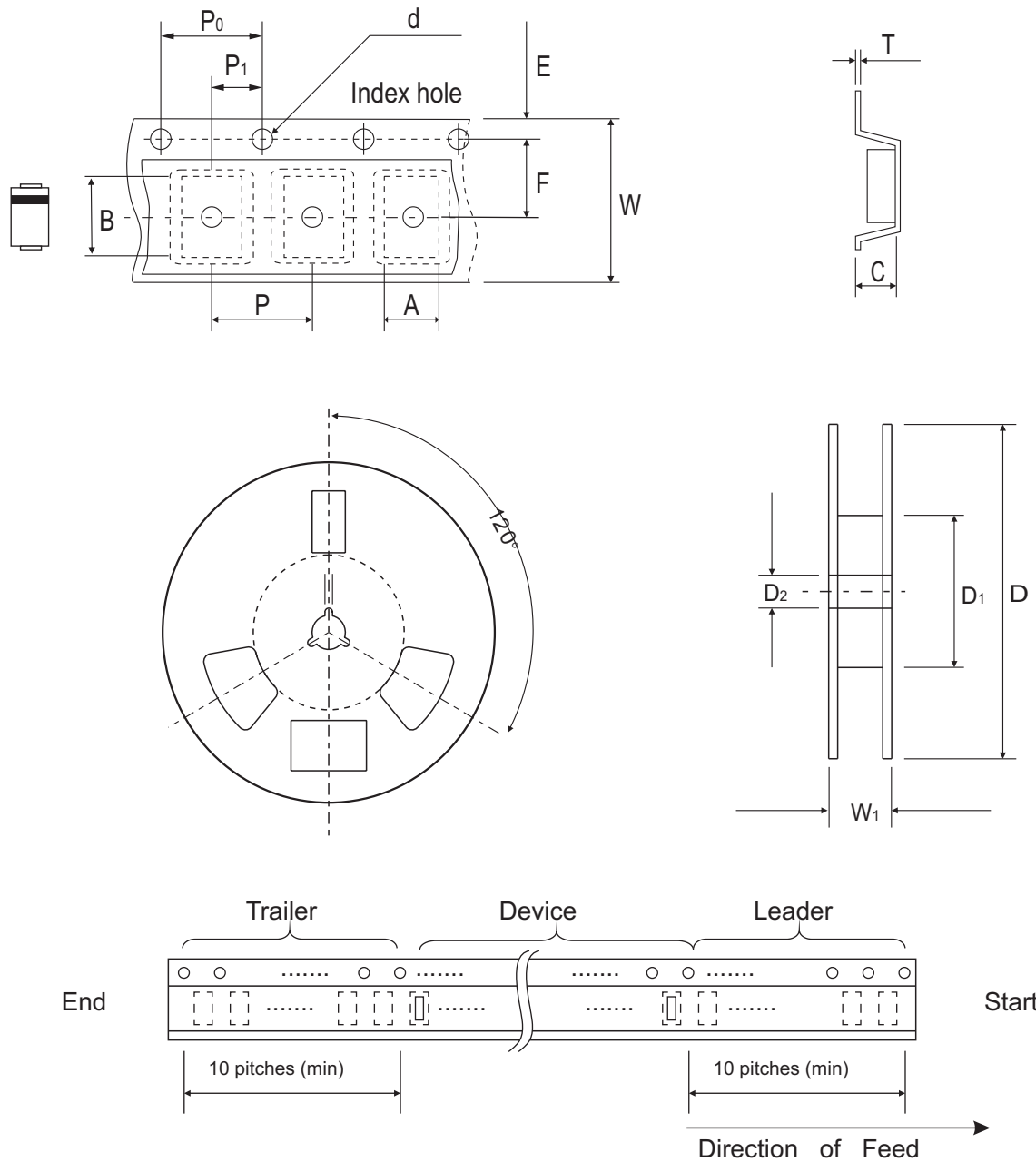

Fig.5 - Typical Reverse Characteristics



Reel Taping Specification



DO-214AA (SMB)	SYMBOL	A	B	C	d	D	D1	D2
	(mm)	4.00 ± 0.10	5.90 ± 0.10	3.00 ± 0.10	1.50 ± 0.10	330 ± 2.00	50.0 MIN.	13.50 ± 0.50
	(inch)	0.157 ± 0.004	0.232 ± 0.004	0.118 ± 0.004	0.059 ± 0.004	12.99 ± 0.079	1.969 MIN.	0.531 ± 0.020

DO-214AA (SMB)	SYMBOL	E	F	P	P0	P1	T	W	W1
	(mm)	1.75 ± 0.10	5.50 ± 0.10	8.00 ± 0.10	4.00 ± 0.10	2.00 ± 0.10	0.60 ± 0.10	12.0 ± 0.30	18.4 ± 1.00
	(inch)	0.069 ± 0.004	0.217 ± 0.004	0.315 ± 0.004	0.157 ± 0.004	0.079 ± 0.004	0.236 ± 0.004	0.472 ± 0.012	0.724 ± 0.040

Marking Code

Part Number	Marking Code
CDBB340-HF	340
CDBB360-HF	360
CDBB3100-HF	3100

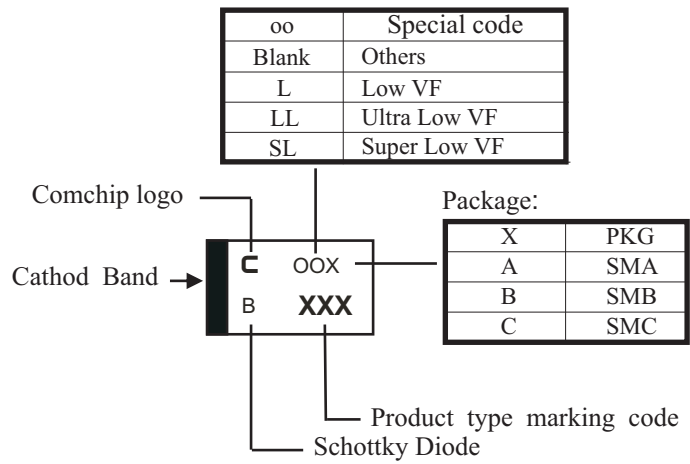

Suggested PAD Layout

SIZE	DO-214AA (SMB)	
	(mm)	(inch)
A	4.30	0.169
B	2.50	0.098
C	2.30	0.091
D	6.80	0.268
E	1.80	0.071

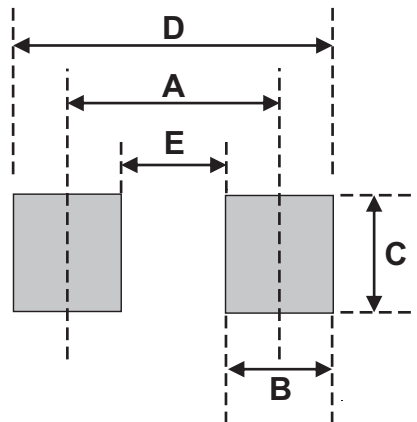

Standard Packaging

Case Type	REEL PACK	
	REEL (pcs)	Reel Size (inch)
DO-214AA (SMB)	3,000	13

Mouser Electronics

Authorized Distributor

Click to View Pricing, Inventory, Delivery & Lifecycle Information:

[Comchip Technology:](#)

[CDBB360-G](#) [CDBB360-HF](#)