

Jul.1.2020 Copyright 2020 HIROSE ELECTRIC CO., LTD. All Rights Reserved.
 In case of consideration for using Automotive equipment / device which demand high reliability, kindly contact our sales window correspondents.

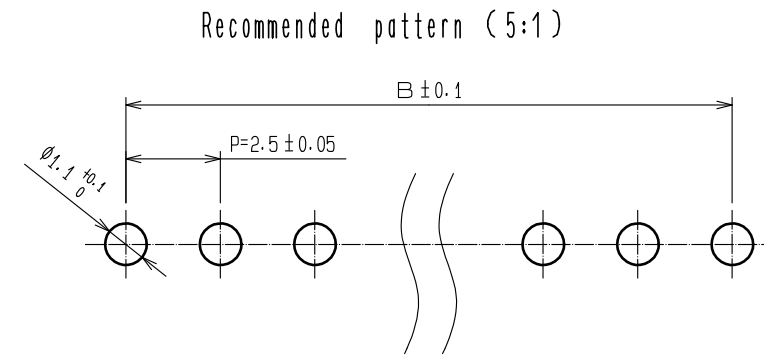
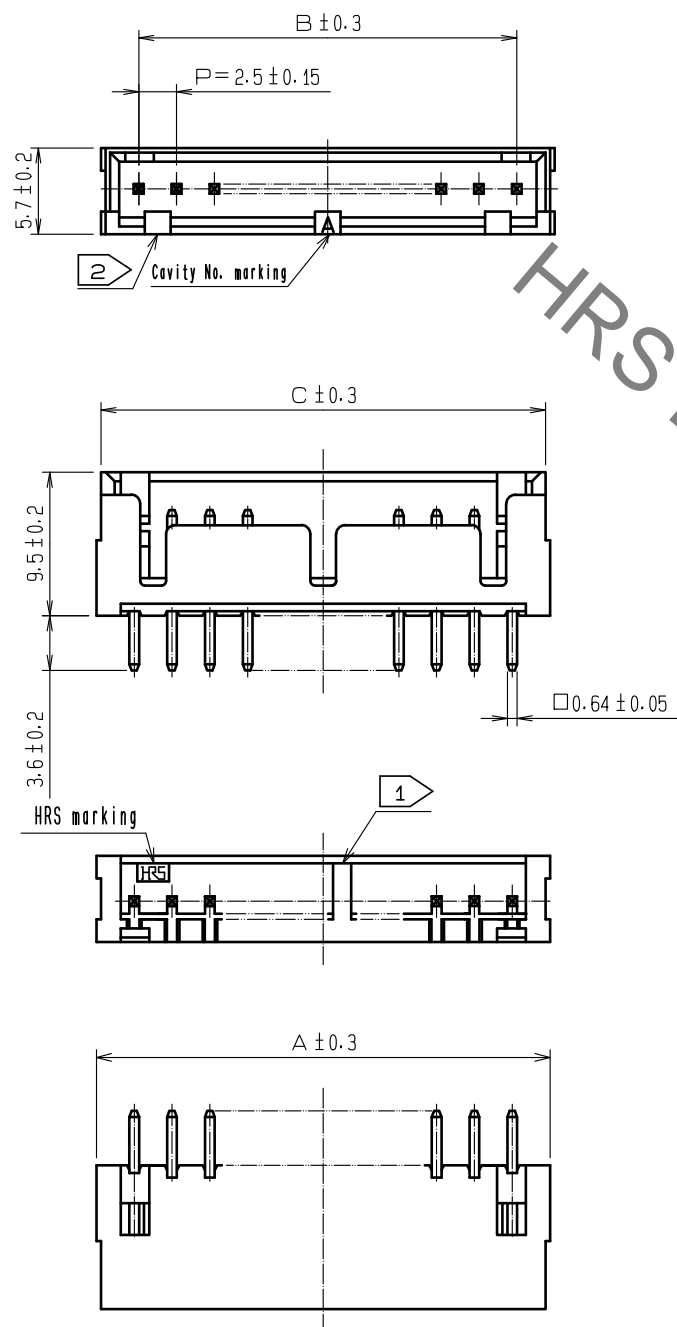

Part No.	Code No.	Contact No.	A	B	C
CL541-0225-7-01	DF1B- 2P-2.5DSA(01)	2	7.5	2.5	6.9
CL541-0226-0-01	DF1B- 3P-2.5DSA(01)	3	10.0	5.0	9.4
CL541-0227-2-01	DF1B- 4P-2.5DSA(01)	4	12.5	7.5	11.9
CL541-0228-5-01	DF1B- 5P-2.5DSA(01)	5	15.0	10.0	14.4
CL541-0229-8-01	DF1B- 6P-2.5DSA(01)	6	17.5	12.5	16.9
CL541-0230-7-01	DF1B- 7P-2.5DSA(01)	7	20.0	15.0	19.4
CL541-0231-0-01	DF1B- 8P-2.5DSA(01)	8	22.5	17.5	21.9
CL541-0232-2-01	DF1B- 9P-2.5DSA(01)	9	25.0	20.0	24.4
CL541-0233-5-01	DF1B-10P-2.5DSA(01)	10	27.5	22.5	26.9
CL541-0235-0-01	DF1B-12P-2.5DSA(01)	12	32.5	27.5	31.9
CL541-0237-6-01	DF1B-14P-2.5DSA(01)	14	37.5	32.5	36.9
CL541-0238-9-01	DF1B-15P-2.5DSA(01)	15	40.0	35.0	39.4
CL541-0239-1-01	DF1B-16P-2.5DSA(01)	16	42.5	37.5	41.9
CL541-0240-0-01	DF1B-18P-2.5DSA(01)	18	47.5	42.5	46.9
CL541-0241-3-01	DF1B-20P-2.5DSA(01)	20	52.5	47.5	51.9

Note 1 When the numbers of contacts is odd.
 The stand-off shifts 1.25 rightward.
 (Stand-off available from 4 positions up.)
 Note 2 2 positions and 3 positions headers have 1 polarizing slot at center.
 To 6 positions from 4 positions have 2 polarizing slots.
 Other positions have 3 polarizing slots as per drawing.

1	Polyamide	UL94V-0, Natural(White)	2	Brass	Surface: Gold plated 0.2μm min. Under plating: Nickel plated 1μm min.
NO.	MATERIAL	FINISH, REMARKS	NO.	MATERIAL	FINISH, REMARKS
UNITS mm		SCALE 2:1	COUNT 1	DESCRIPTION OF REVISIONS DIS-H-00004686	DESIGNED SN. MIWA
APPROVED: TY. OMA		20060805	DRAWING NO. EDC-071798-01-03		
CHECKED: HK. UMEHARA		20060805	PART NO. DF1B-*P-2.5DSA(01)		
DESIGNED: AH. MIYAZAKI		20060805	CODE NO. CL541-		
DRAWN: AK. MIURA		20060805	DATE 20190306		