

IRF7410GPbF

HEXFET® Power MOSFET

- Ultra Low On-Resistance
- P-Channel MOSFET
- Surface Mount
- Available in Tape & Reel
- Lead-Free
- Halogen-Free

| V_{DSS} | $R_{DS(on) \text{ max}}$ | I_D |
|-----------|--|--------|
| -12V | $7\text{m}\Omega @ V_{GS} = -4.5\text{V}$ | -16A |
| | $9\text{m}\Omega @ V_{GS} = -2.5\text{V}$ | -13.6A |
| | $13\text{m}\Omega @ V_{GS} = -1.8\text{V}$ | -11.5A |

Description

These P-Channel HEXFET® Power MOSFETs from International Rectifier utilize advanced processing techniques to achieve the extremely low on-resistance per silicon area. This benefit provides the designer with an extremely efficient device for use in battery and load management applications..

The SO-8 has been modified through a customized leadframe for enhanced thermal characteristics and multiple-die capability making it ideal in a variety of power applications. With these improvements, multiple devices can be used in an application with dramatically reduced board space. The package is designed for vapor phase, infrared, or wave soldering techniques.

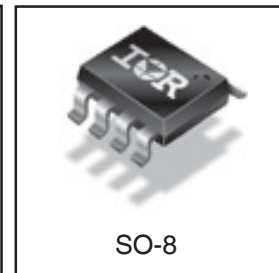
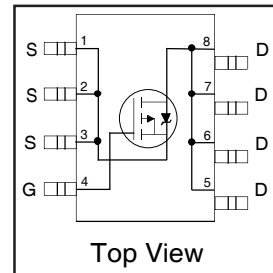

Absolute Maximum Ratings

| | Parameter | Max. | Units |
|--------------------------------|---|-------------|-------|
| V_{DS} | Drain- Source Voltage | -12 | V |
| $I_D @ T_A = 25^\circ\text{C}$ | Continuous Drain Current, $V_{GS} @ -4.5\text{V}$ | -16 | A |
| $I_D @ T_A = 70^\circ\text{C}$ | Continuous Drain Current, $V_{GS} @ -4.5\text{V}$ | -13 | |
| I_{DM} | Pulsed Drain Current ① | -65 | |
| $P_D @ T_A = 25^\circ\text{C}$ | Power Dissipation ③ | 2.5 | W |
| $P_D @ T_A = 70^\circ\text{C}$ | Power Dissipation ③ | 1.6 | |
| | Linear Derating Factor | 20 | mW/°C |
| V_{GS} | Gate-to-Source Voltage | ± 8 | V |
| T_J, T_{STG} | Junction and Storage Temperature Range | -55 to +150 | °C |

Thermal Resistance

| | Parameter | Max. | Units |
|-----------------|-------------------------------|------|-------|
| $R_{\theta JA}$ | Maximum Junction-to-Ambient ③ | 50 | °C/W |

Electrical Characteristics @ T_J = 25°C (unless otherwise specified)

| Symbol | Parameter | Min. | Typ. | Max. | Units | Conditions |
|--|--------------------------------------|------|-------|------|-------|--|
| V _{(BR)DSS} | Drain-to-Source Breakdown Voltage | -12 | — | — | V | V _{GS} = 0V, I _D = -250μA |
| ΔV _{(BR)DSS} /ΔT _J | Breakdown Voltage Temp. Coefficient | — | 0.006 | — | V/°C | Reference to 25°C, I _D = -1mA |
| R _{DS(on)} | Static Drain-to-Source On-Resistance | — | — | 7 | mΩ | V _{GS} = -4.5V, I _D = -16A ② |
| | | — | — | 9 | | V _{GS} = -2.5V, I _D = -13.6A ② |
| | | — | — | 13 | | V _{GS} = -1.8V, I _D = -11.5A ② |
| V _{GS(th)} | Gate Threshold Voltage | -0.4 | — | -0.9 | V | V _{DS} = V _{GS} , I _D = -250μA |
| ΔV _{GS(th)} /ΔT _J | Gate Threshold Voltage Coefficient | — | -3.09 | — | mV/°C | |
| g _{fs} | Forward Transconductance | 55 | — | — | S | V _{DS} = -10V, I _D = -16A |
| I _{DSS} | Drain-to-Source Leakage Current | — | — | -1.0 | μA | V _{DS} = -9.6V, V _{GS} = 0V |
| | | — | — | -25 | | V _{DS} = -9.6V, V _{GS} = 0V, T _J = 70°C |
| I _{GSS} | Gate-to-Source Forward Leakage | — | — | -100 | nA | V _{GS} = -8V |
| | Gate-to-Source Reverse Leakage | — | — | 100 | | V _{GS} = 8V |
| Q _g | Total Gate Charge | — | 91 | — | nC | I _D = -16A |
| Q _{gs} | Gate-to-Source Charge | — | 18 | — | | V _{DS} = -9.6V |
| Q _{gd} | Gate-to-Drain ("Miller") Charge | — | 25 | — | | V _{GS} = -4.5V ② |
| t _{d(on)} | Turn-On Delay Time | — | 13 | 20 | ns | V _{DD} = -6V V _{GS} = -4.5V |
| t _r | Rise Time | — | 12 | 18 | | I _D = -1.0A |
| t _{d(off)} | Turn-Off Delay Time | — | 271 | 407 | | R _D = 6Ω |
| t _f | Fall Time | — | 200 | 300 | | R _G = 6Ω ② |
| C _{iss} | Input Capacitance | — | 8676 | — | pF | V _{GS} = 0V |
| C _{oss} | Output Capacitance | — | 2344 | — | | V _{DS} = -10V |
| C _{rss} | Reverse Transfer Capacitance | — | 1604 | — | | f = 1.0 MHz |

Source-Drain Ratings and Characteristics

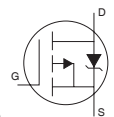
| Symbol | Parameter | Min. | Typ. | Max. | Units | Conditions |
|-----------------|---|------|------|------|-------|--|
| I _S | Continuous Source Current (Body Diode) | — | — | -2.5 | A | MOSFET symbol showing the integral reverse p-n junction diode.  |
| I _{SM} | Pulsed Source Current (Body Diode) ① | — | — | -65 | | |
| V _{SD} | Diode Forward Voltage | — | — | -1.2 | V | T _J = 25°C, I _S = -2.5A, V _{GS} = 0V ② |
| t _{rr} | Reverse Recovery Time | — | 97 | 145 | ns | T _J = 25°C I _F = -2.5A |
| Q _{rr} | Reverse Recovery Charge | — | 134 | 201 | μC | di/dt = -100A/μs ② |

Notes:

- ① Repetitive rating; pulse width limited by max. junction temperature.
 ② Pulse width ≤ 400μs; duty cycle ≤ 2%.
 ③ Surface mounted on 1 in square Cu board, t ≤ 10sec.

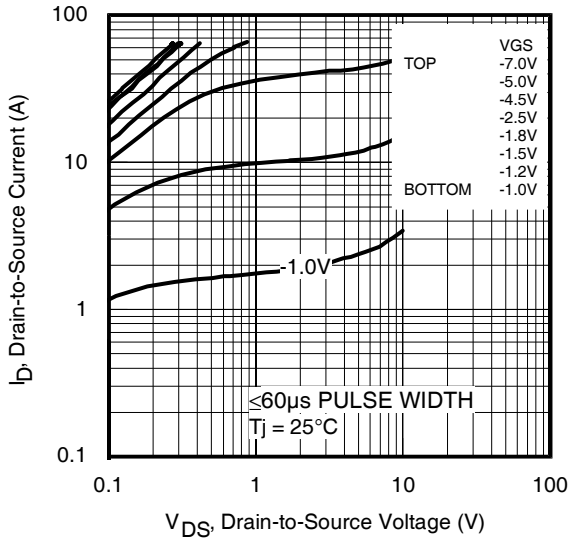

Fig 1. Typical Output Characteristics

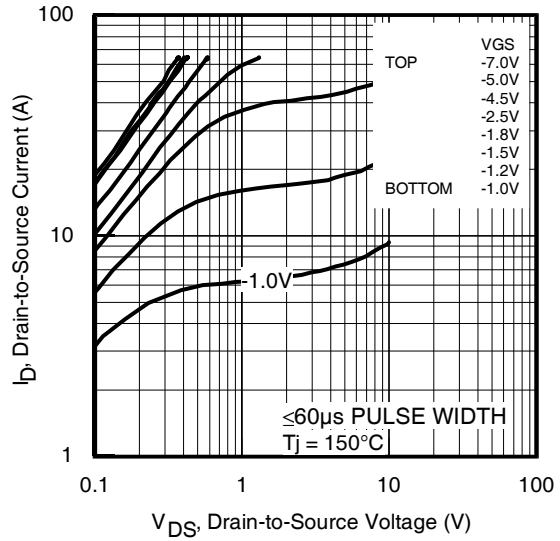

Fig 2. Typical Output Characteristics

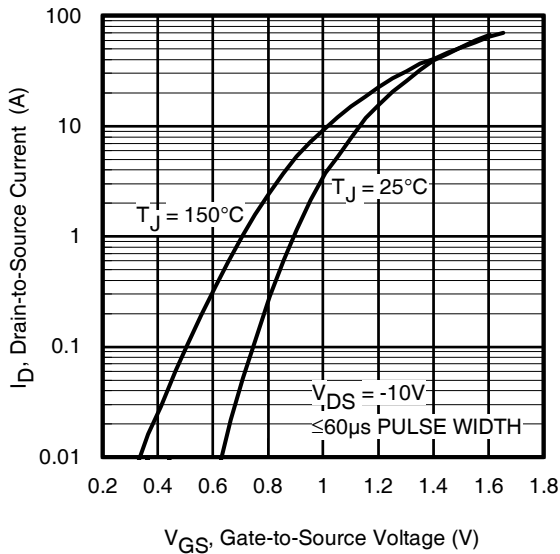

Fig 3. Typical Transfer Characteristics

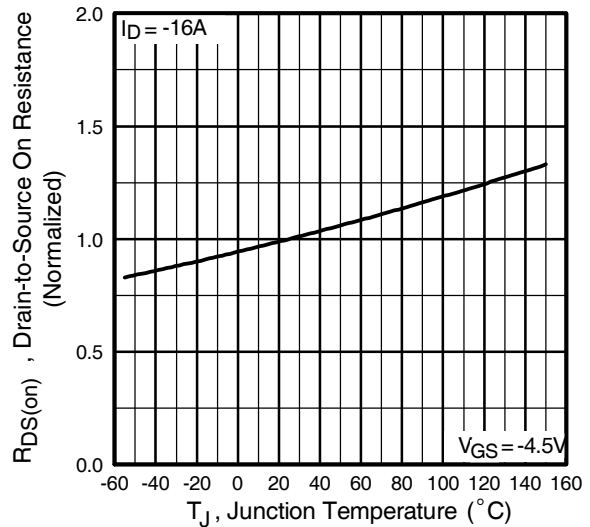

Fig 4. Normalized On-Resistance Vs. Temperature

IRF7410GPbF

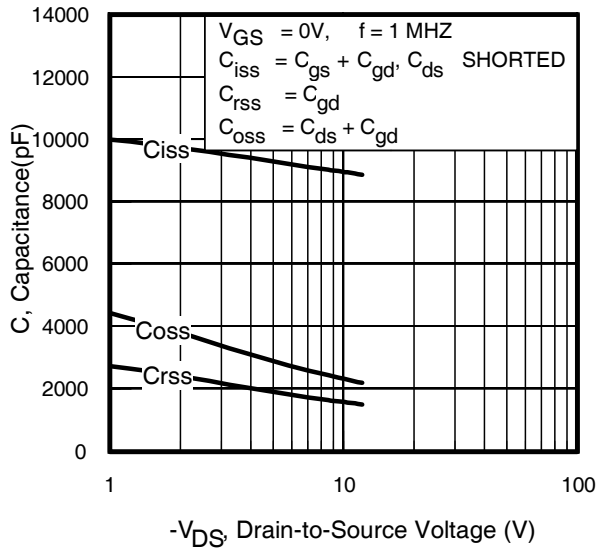

Fig 5. Typical Capacitance Vs. Drain-to-Source Voltage

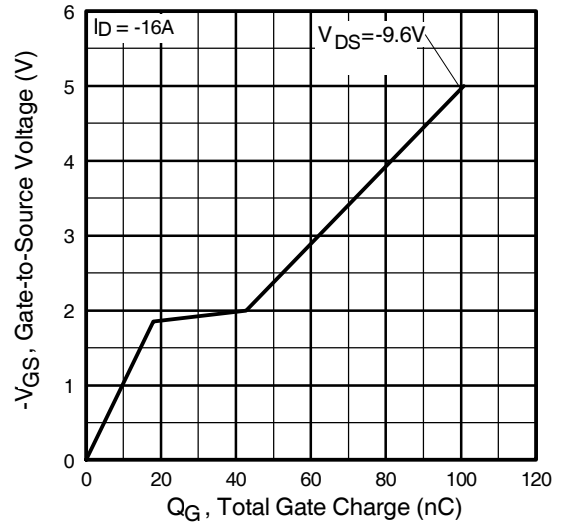

Fig 6. Typical Gate Charge Vs. Gate-to-Source Voltage

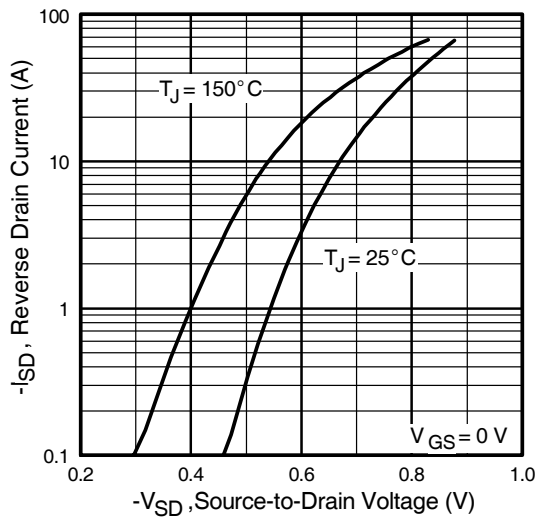

Fig 7. Typical Source-Drain Diode Forward Voltage

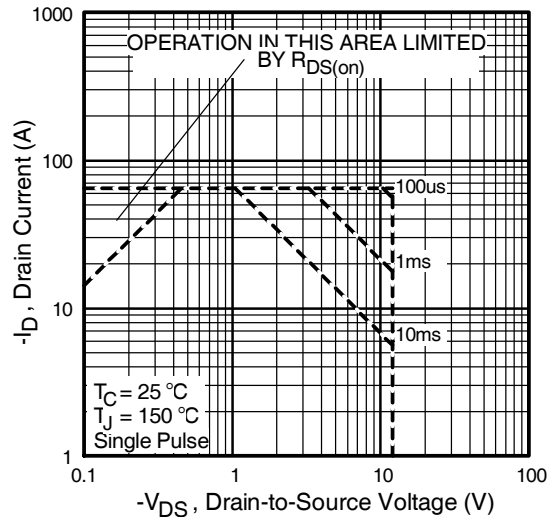

Fig 8. Maximum Safe Operating Area

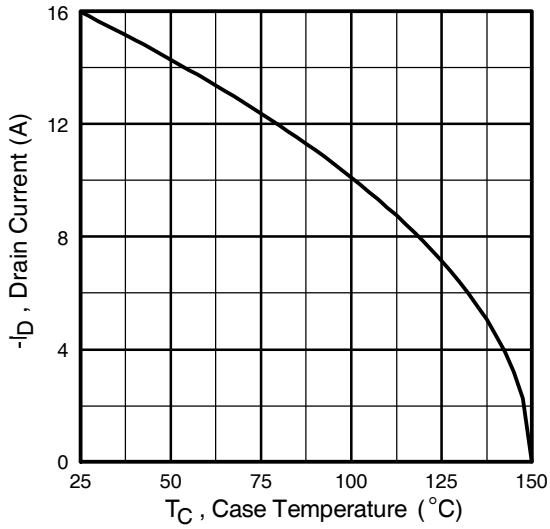

Fig 9. Maximum Drain Current Vs. Case Temperature

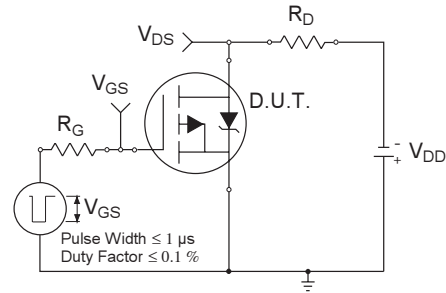

Fig 10a. Switching Time Test Circuit

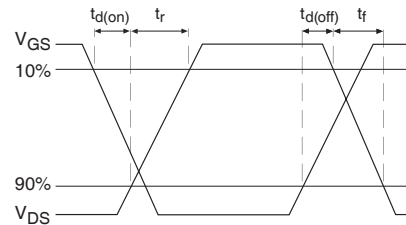

Fig 10b. Switching Time Waveforms

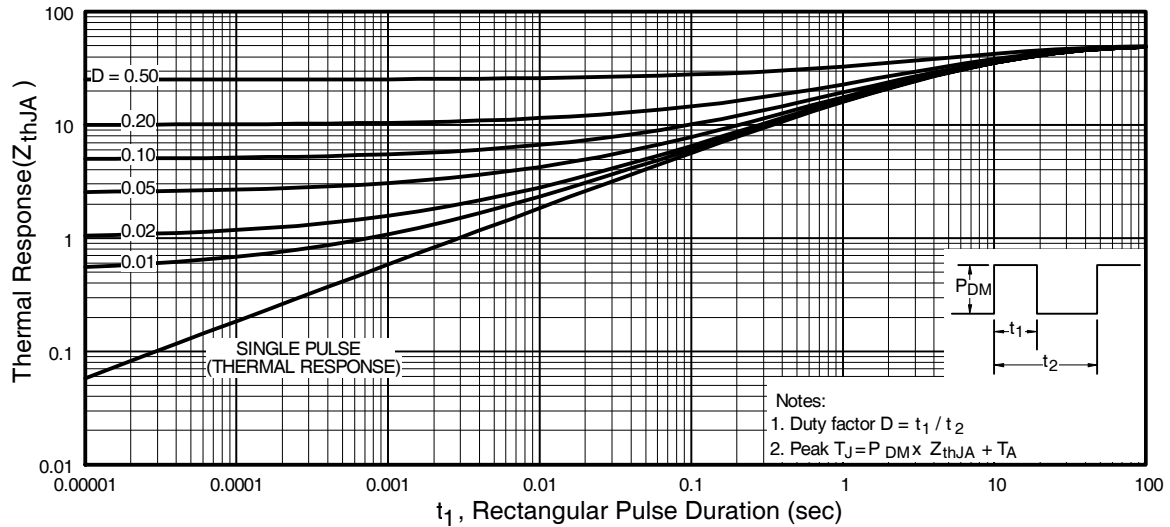

Fig 11. Maximum Effective Transient Thermal Impedance, Junction-to-Ambient

IRF7410GPbF

International
IR Rectifier

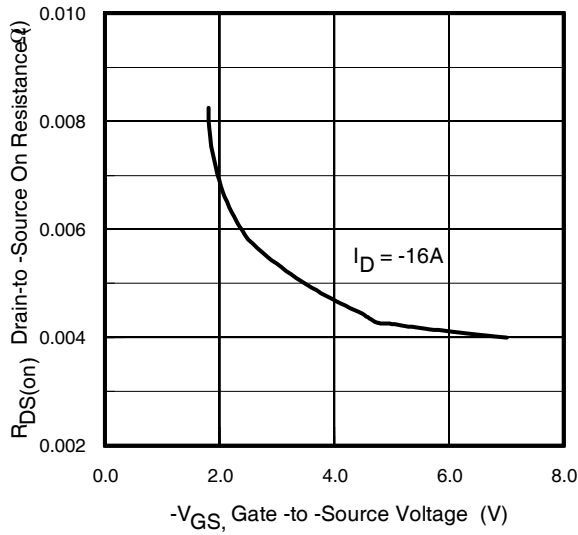

Fig 12. Typical On-Resistance Vs. Gate Voltage

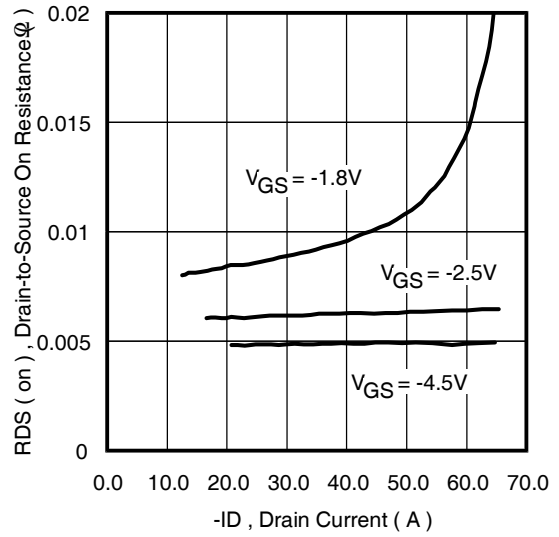

Fig 13. Typical On-Resistance Vs. Drain Current



Fig 14a. Basic Gate Charge Waveform



Fig 14b. Gate Charge Test Circuit

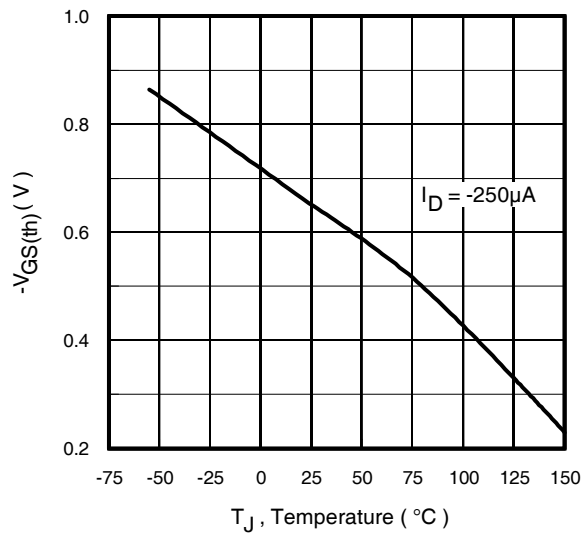

Fig 15. Typical $V_{GS(th)}$ Vs. Junction Temperature

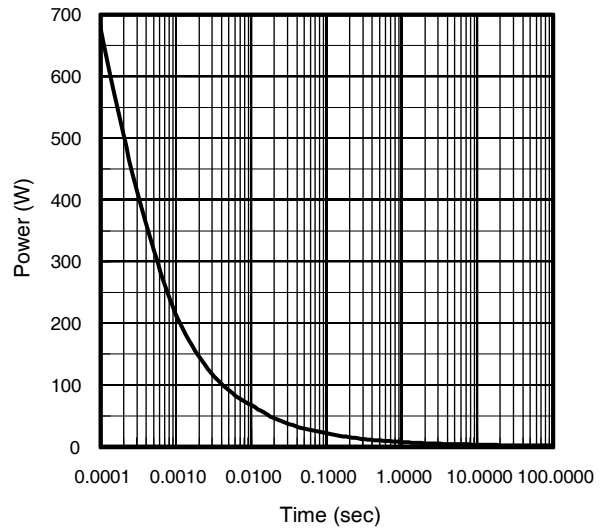

Fig 16. Typical Power Vs. Time

IRF7410GPbF

International
IR Rectifier

SO-8 Package Outline (MOSFET & Fetky)

Dimensions are shown in millimeters (inches)

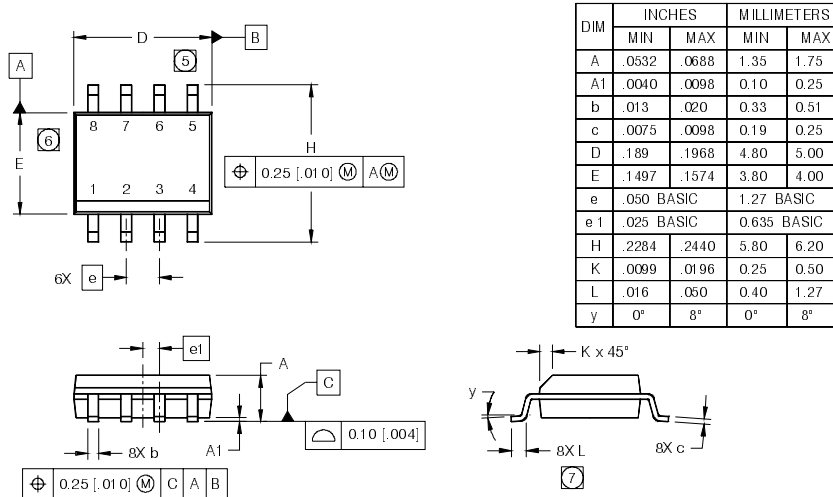

NOTES:

1. DIMENSIONING & TOLERANCING PER ASME Y14.5M-1994.
2. CONTROLLING DIMENSION: MILLIMETER
3. DIMENSIONS ARE SHOWN IN MILLIMETERS [INCHES].
4. OUTLINE CONFORMS TO JEDEC OUTLINE MS-012AA.
- ⑤ DIMENSION DOES NOT INCLUDE MOLD PROTRUSIONS. MOLD PROTRUSIONS NOT TO EXCEED 0.15 [.006].
- ⑥ DIMENSION DOES NOT INCLUDE MOLD PROTRUSIONS. MOLD PROTRUSIONS NOT TO EXCEED 0.25 [.010].
- ⑦ DIMENSION IS THE LENGTH OF LEAD FOR SOLDERING TO A SUBSTRATE.

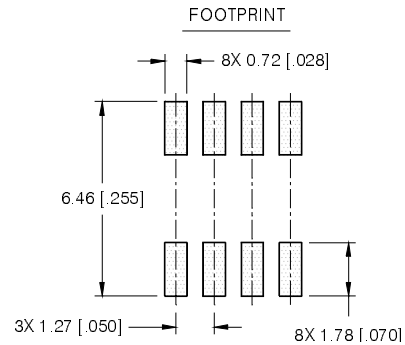

SO-8 Part Marking Information

EXAMPLE: THIS IS AN IRF8707GPBF

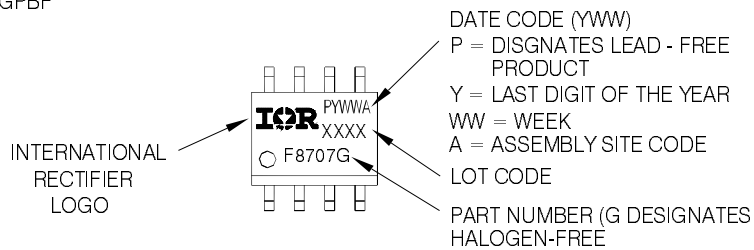

Note: For the most current drawing please refer to IR website at <http://www.irf.com/package/>

SO-8 Tape and Reel

Dimensions are shown in millimeters (inches)

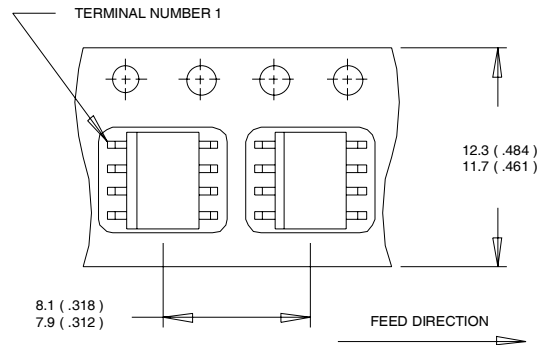

- NOTES:
1. CONTROLLING DIMENSION : MILLIMETER.
 2. ALL DIMENSIONS ARE SHOWN IN MILLIMETERS(INCHES).
 3. OUTLINE CONFORMS TO EIA-481 & EIA-541.

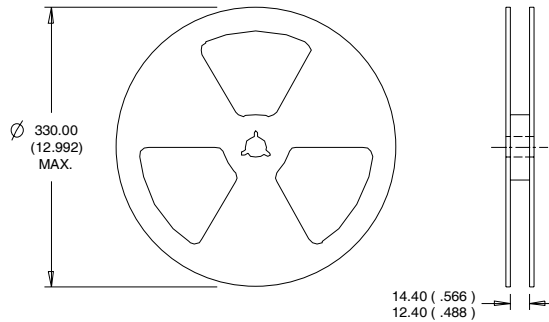

- NOTES:
1. CONTROLLING DIMENSION : MILLIMETER.
 2. OUTLINE CONFORMS TO EIA-481 & EIA-541.

Note: For the most current drawing please refer to IR website at <http://www.irf.com/package/>

Data and specifications subject to change without notice.
This product has been designed and qualified for the Consumer market.
Qualification Standards can be found on IR's Web site.

Mouser Electronics

Authorized Distributor

Click to View Pricing, Inventory, Delivery & Lifecycle Information:

[Infineon:](#)

[IRF7410GTRPBF](#)