

FEATURES

- 225 ps propagation delay through the switch
- 4.5 Ω switch connection between ports
- Data rate 1.5 Gbps
- 2.5 V/3.3 V supply operation
- Selectable level shifting/translation
- Level translation
 - 3.3 V to 2.5 V
 - 3.3 V to 1.8 V
 - 2.5 V to 1.8 V
- Small signal bandwidth 770 MHz
- Tiny 6-lead SC70 package and 6-lead SOT-66 package

APPLICATIONS

- 3.3 V to 1.8 V voltage translation
- 3.3 V to 2.5 V voltage translation
- 2.5 V to 1.8 V voltage translation
- Bus switching
- Bus isolation
- Hot swap
- Hot plug
- Analog switch applications

GENERAL DESCRIPTION

The ADG3241 is a 2.5 V or 3.3 V single digital switch. It is designed on a low voltage CMOS process that provides low power dissipation yet gives high switching speed and very low on resistance. This allows the input to be connected to the output without additional propagation delay or generating additional ground bounce noise.

The switch is enabled by means of the bus enable ($\overline{\text{BE}}$) input signal. This digital switch allows a bidirectional signal to be switched when on. In the off condition, signal levels up to the supplies are blocked.

This device is ideal for applications requiring level translation. When operated from a 3.3 V supply, level translation from 3.3 V inputs to 2.5 V outputs is allowed. Similarly, if the device is operated from a 2.5 V supply and 2.5 V inputs are applied, the device translates the outputs to 1.8 V. In addition to this, a level

FUNCTIONAL BLOCK DIAGRAM

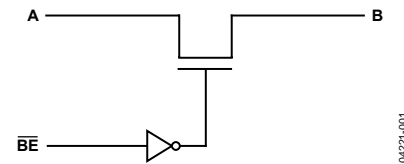

Figure 1.

04221-001

translating select pin ($\overline{\text{SEL}}$) is included. When $\overline{\text{SEL}}$ is low, V_{CC} is reduced internally, allowing for level translation between 3.3 V inputs and 1.8 V outputs. This makes the device suited to applications requiring level translation between different supplies, such as converter to DSP/microcontroller interfacing.

PRODUCT HIGHLIGHTS

1. 3.3 V or 2.5 V supply operation.
2. Extremely low propagation delay through switch.
3. 4.5 Ω switches connect inputs to outputs.
4. Level and voltage translation.
5. Tiny, SC70 package and SOT-66 package.

Rev. B

Information furnished by Analog Devices is believed to be accurate and reliable. However, no responsibility is assumed by Analog Devices for its use, nor for any infringements of patents or other rights of third parties that may result from its use. Specifications subject to change without notice. No license is granted by implication or otherwise under any patent or patent rights of Analog Devices. Trademarks and registered trademarks are the property of their respective owners.

TABLE OF CONTENTS

| | | | |
|--|----|---|----|
| Features | 1 | Timing Measurement Information | 11 |
| Applications..... | 1 | Bus Switch Applications | 12 |
| Functional Block Diagram | 1 | Mixed Voltage Operation, Level Translation..... | 12 |
| General Description | 1 | 3.3 V to 2.5 V Translation | 12 |
| Product Highlights | 1 | 2.5 V to 1.8 V Translation | 12 |
| Revision History | 2 | 3.3 V to 1.8 V Translation | 12 |
| Specifications..... | 3 | Bus Isolation..... | 13 |
| Absolute Maximum Ratings..... | 4 | Hot Plug and Hot Swap Isolation..... | 13 |
| ESD Caution..... | 4 | Analog Switching | 13 |
| Pin Configuration and Function Descriptions..... | 5 | High Impedance During Power-Up/Power-Down..... | 13 |
| Typical Performance Characteristics | 6 | Outline Dimensions | 14 |
| Terminology | 10 | Ordering Guide | 14 |

REVISION HISTORY

5/06 — Rev. A to Rev. B

| | |
|---------------------------------|-----------|
| Updated Format..... | Universal |
| Changes to Table 4..... | 5 |
| Changes to Ordering Guide | 14 |

10/04 — Rev. 0 to Rev. A.

| | |
|---------------------------------|---|
| Changes to Features..... | 1 |
| Changes to Specifications | 2 |

| | |
|--|----|
| Changes to Absolute Maximum Ratings..... | 3 |
| Changes to Pin Configurations | 4 |
| Changes to Ordering Guide | 4 |
| Updated Outline Dimensions..... | 11 |

7/03—Revision 0: Initial Version

SPECIFICATIONS

$V_{CC} = 2.3\text{ V to }3.6\text{ V}$, $GND = 0\text{ V}$, all specifications T_{MIN} to T_{MAX} , unless otherwise noted.¹

Table 1.

| Parameter | Symbol | Conditions | B Version | | | Unit |
|---|--------------------|--|-----------|------------------|-------|--------|
| | | | Min | Typ ² | Max | |
| DC ELECTRICAL CHARACTERISTICS | | | | | | |
| Input High Voltage | V_{INH} | $V_{CC} = 2.7\text{ V to }3.6\text{ V}$ | 2.0 | | | V |
| | V_{INH} | $V_{CC} = 2.3\text{ V to }2.7\text{ V}$ | 1.7 | | | V |
| Input Low Voltage | V_{INL} | $V_{CC} = 2.7\text{ V to }3.6\text{ V}$ | | | 0.8 | V |
| | V_{INL} | $V_{CC} = 2.3\text{ V to }2.7\text{ V}$ | | | 0.7 | V |
| Input Leakage Current | I_I | | | ±0.01 | ±1 | µA |
| Off State Leakage Current | I_{OZ} | $0 \leq A, B \leq V_{CC}$ | | ±0.01 | ±1 | µA |
| On State Leakage Current | | $0 \leq A, B \leq V_{CC}$ | | ±0.01 | ±1 | µA |
| Maximum Pass Voltage | V_P | $V_A/V_B = V_{CC} = \overline{SEL} = 3.3\text{ V}, I_O = -5\text{ µA}$ | 2.2 | 2.5 | 2.7 | V |
| | | $V_A/V_B = V_{CC} = \overline{SEL} = 2.5\text{ V}, I_O = -5\text{ µA}$ | 1.5 | 1.8 | 2.1 | V |
| | | $V_A/V_B = V_{CC} = 3.3\text{ V}, \overline{SEL} = 0\text{ V}, I_O = -5\text{ µA}$ | 1.5 | 1.8 | 2.1 | V |
| CAPACITANCE³ | | | | | | |
| A Port Off Capacitance | C_A OFF | $f = 1\text{ MHz}$ | | 3.5 | | pF |
| B Port Off Capacitance | C_B OFF | $f = 1\text{ MHz}$ | | 3.5 | | pF |
| A, B Port On Capacitance | C_A, C_B ON | $f = 1\text{ MHz}$ | | 7 | | pF |
| Control Input Capacitance | C_{IN} | $f = 1\text{ MHz}$ | | 4 | | pF |
| SWITCHING CHARACTERISTICS³ | | | | | | |
| Propagation Delay A to B or B to A, t_{PD} ⁴ | t_{PHL}, t_{PLH} | $C_L = 50\text{ pF}, V_{CC} = \overline{SEL} = 3\text{ V}$ | | | 0.225 | ns |
| Bus Enable Time \overline{BE} to A or B ⁵ | t_{PZH}, t_{PZL} | $V_{CC} = 3.0\text{ V to }3.6\text{ V}; \overline{SEL} = V_{CC}$ | 1 | 3.2 | 4.6 | ns |
| Bus Disable Time \overline{BE} to A or B ⁵ | t_{PHZ}, t_{PLZ} | $V_{CC} = 3.0\text{ V to }3.6\text{ V}; \overline{SEL} = V_{CC}$ | 1 | 3 | 4 | ns |
| Bus Enable Time \overline{BE} to A or B ⁵ | t_{PZH}, t_{PZL} | $V_{CC} = 3.0\text{ V to }3.6\text{ V}; \overline{SEL} = 0\text{ V}$ | 1 | 3 | 4 | ns |
| Bus Disable Time \overline{BE} to A or B ⁵ | t_{PHZ}, t_{PLZ} | $V_{CC} = 3.0\text{ V to }3.6\text{ V}; \overline{SEL} = 0\text{ V}$ | 1 | 2.5 | 3.8 | ns |
| Bus Enable Time \overline{BE} to A or B ⁵ | t_{PZH}, t_{PZL} | $V_{CC} = 2.3\text{ V to }2.7\text{ V}; \overline{SEL} = V_{CC}$ | 1 | 3 | 4 | ns |
| Bus Disable Time \overline{BE} to A or B ⁵ | t_{PHZ}, t_{PLZ} | $V_{CC} = 2.3\text{ V to }2.7\text{ V}; \overline{SEL} = V_{CC}$ | 1 | 2.5 | 3.4 | ns |
| Maximum Data Rate | | $V_{CC} = \overline{SEL} = 3.3\text{ V}; V_A/V_B = 2\text{ V}$ | | 1.5 | | Gbps |
| Channel Jitter | | $V_{CC} = \overline{SEL} = 3.3\text{ V}; V_A/V_B = 2\text{ V}$ | | 45 | | ps p-p |
| DIGITAL SWITCH | | | | | | |
| On Resistance | R_{ON} | $V_{CC} = 3\text{ V}, \overline{SEL} = V_{CC}, V_A = 0\text{ V}, I_{BA} = 8\text{ mA}$ | 4.5 | | 8 | Ω |
| | | $V_{CC} = 3\text{ V}, \overline{SEL} = V_{CC}, V_A = 1.7\text{ V}, I_{BA} = 8\text{ mA}$ | 12 | | 28 | Ω |
| | | $V_{CC} = 2.3\text{ V}, \overline{SEL} = V_{CC}, V_A = 0\text{ V}, I_{BA} = 8\text{ mA}$ | 5 | | 9 | Ω |
| | | $V_{CC} = 2.3\text{ V}, \overline{SEL} = V_{CC}, V_A = 1\text{ V}, I_{BA} = 8\text{ mA}$ | 9 | | 18 | Ω |
| | | $V_{CC} = 3\text{ V}, \overline{SEL} = 0\text{ V}, V_A = 0\text{ V}, I_{BA} = 8\text{ mA}$ | 5 | | 8 | Ω |
| | | $V_{CC} = 3\text{ V}, \overline{SEL} = 0\text{ V}, V_A = 1\text{ V}, I_{BA} = 8\text{ mA}$ | 12 | | | Ω |
| POWER REQUIREMENTS | | | | | | |
| V_{CC} | | | 2.3 | | 3.6 | V |
| Quiescent Power Supply Current | I_{CC} | Digital Inputs = 0 V or V_{CC} ; $\overline{SEL} = V_{CC}$ | | 0.01 | 1 | µA |
| | | Digital Inputs = 0 V or V_{CC} ; $\overline{SEL} = 0\text{ V}$ | | 0.1 | 0.2 | mA |
| Increase in I_{CC} per Input ⁶ | ΔI_{CC} | $V_{CC} = 3.6\text{ V}, \overline{BE} = 3.0\text{ V}; \overline{SEL} = V_{CC}$ | | 0.15 | 8 | µA |

¹ Temperature range is as follows: B Version: -40°C to $+85^\circ\text{C}$.

² Typical values are at 25°C , unless otherwise stated.

³ Guaranteed by design, not subject to production test.

⁴ The digital switch contributes no propagation delay other than the RC delay of the typical R_{ON} of the switch and the load capacitance when driven by an ideal voltage source. Since the time constant is much smaller than the rise/fall times of typical driving signals, it adds very little propagation delay to the system. Propagation delay of the digital switch, when used in a system, is determined by the driving circuit on the driving side of the switch and its interaction with the load on the driven side.

⁵ See Timing Measurement Information section.

⁶ This current applies to the Control Pin \overline{BE} only. The A and B ports contribute no significant ac or dc currents as they transition.

ABSOLUTE MAXIMUM RATINGS

T_A = 25°C, unless otherwise noted.

Table 2.

| Parameter | Rating |
|---------------------------------------|-------------------------|
| V _{CC} to GND | −0.5 V to +4.6 V |
| Digital Inputs to GND | −0.5 V to +4.6 V |
| DC Input Voltage | −0.5 V to +4.6 V |
| DC Output Current | 25 mA per channel |
| Operating Temperature Range | |
| Industrial (B Version) | −40°C to +85°C |
| Storage Temperature Range | −65°C to +150°C |
| Junction Temperature | 150°C |
| SC70 Package | |
| θ _{JA} Thermal Impedance | 332°C/W |
| SOT-66 Package | |
| θ _{JA} Thermal Impedance | 191°C/W (4-layer board) |
| Lead Temperature, Soldering (10 sec) | 300°C |
| IR Reflow, Peak Temperature (<20 sec) | 235°C |

Stresses above those listed under Absolute Maximum Ratings may cause permanent damage to the device. This is a stress rating only; functional operation of the device at these or any other conditions above those indicated in the operational section of this specification is not implied. Exposure to absolute maximum rating conditions for extended periods may affect device reliability.

Only one absolute maximum rating can be applied at any one time.

ESD CAUTION

ESD (electrostatic discharge) sensitive device. Electrostatic charges as high as 4000 V readily accumulate on the human body and test equipment and can discharge without detection. Although this product features proprietary ESD protection circuitry, permanent damage may occur on devices subjected to high energy electrostatic discharges. Therefore, proper ESD precautions are recommended to avoid performance degradation or loss of functionality.



PIN CONFIGURATION AND FUNCTION DESCRIPTIONS

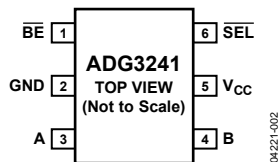

Figure 2. 6-Lead SC70

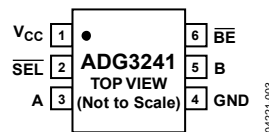

Figure 3. 6-Lead SOT-66

Table 3. Pin Function Descriptions

| Pin No. | | Mnemonic | Description |
|---------|--------|-----------------|-------------------------------|
| SC70 | SOT-66 | | |
| 1 | 6 | BE | Bus Enable (Active Low) |
| 2 | 4 | GND | Ground Reference |
| 3 | 3 | A | Port A, Input or Output |
| 4 | 5 | B | Port B, Input or Output |
| 5 | 1 | V _{CC} | Positive Power Supply Voltage |
| 6 | 2 | SEL | Level Translation Select |

Table 4. Truth Table

| BE | SEL ¹ | Function |
|----|------------------|---|
| L | L | A = B, 3.3 V to 1.8 V level shifting |
| L | H | A = B, 3.3 V to 2.5 V/2.5 V to 1.8 V level shifting |
| H | X | Disconnect |

¹ SEL = 0 V only when V_{DD} = 3.3 V ± 10%.

TYPICAL PERFORMANCE CHARACTERISTICS

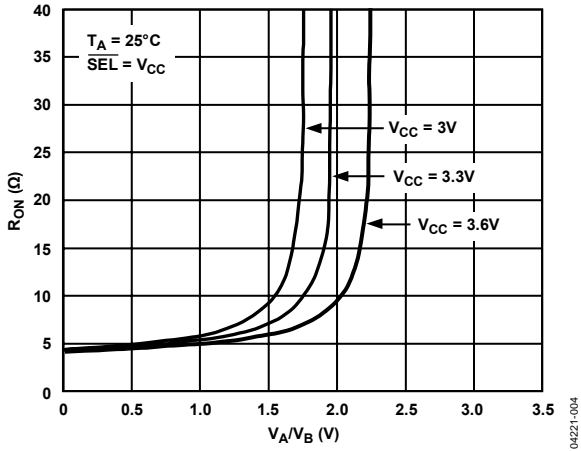

Figure 4. On Resistance vs. Input Voltage

04221-004

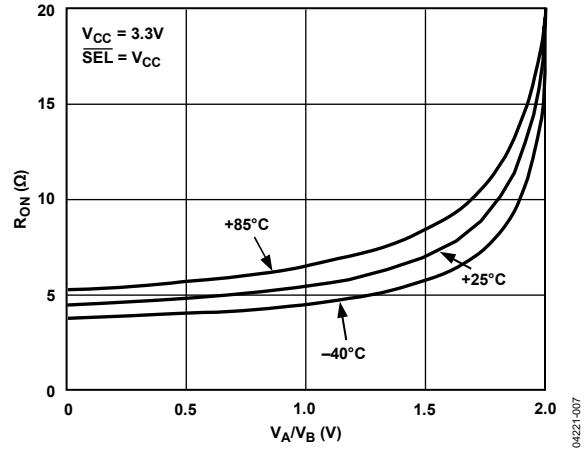

Figure 7. On Resistance vs. Input Voltage for Different Temperatures

04221-007

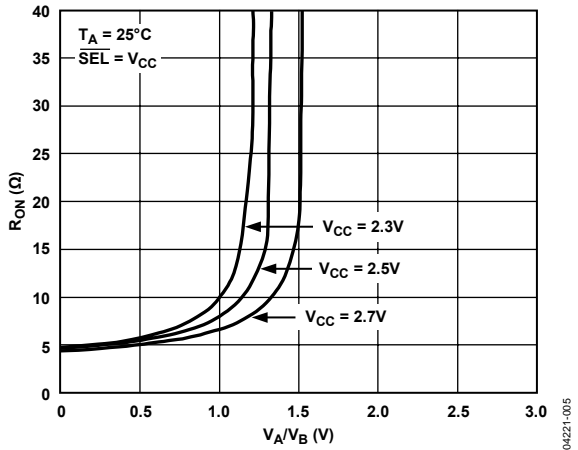

Figure 5. On Resistance vs. Input Voltage

04221-005

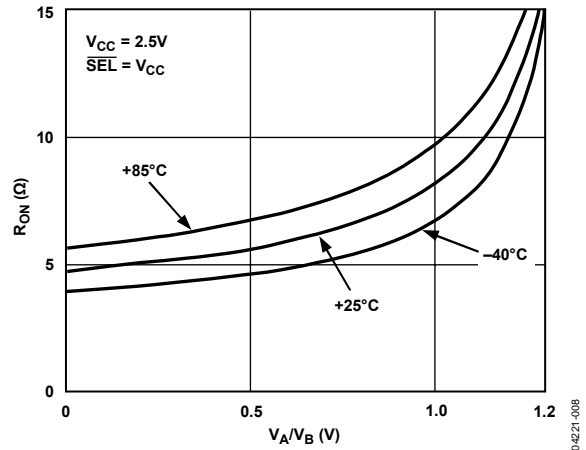

Figure 8. On Resistance vs. Input Voltage for Different Temperatures

04221-008

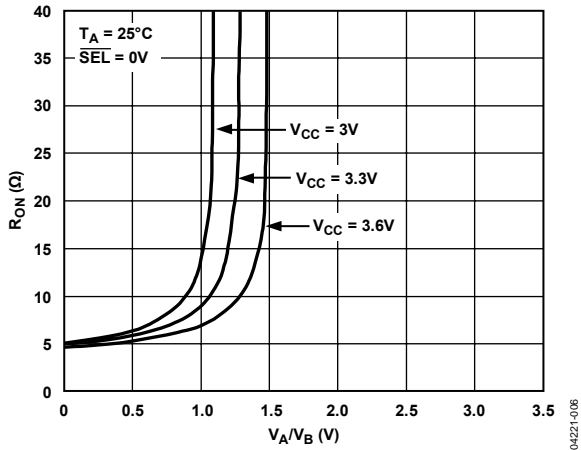

Figure 6. On Resistance vs. Input Voltage

04221-006

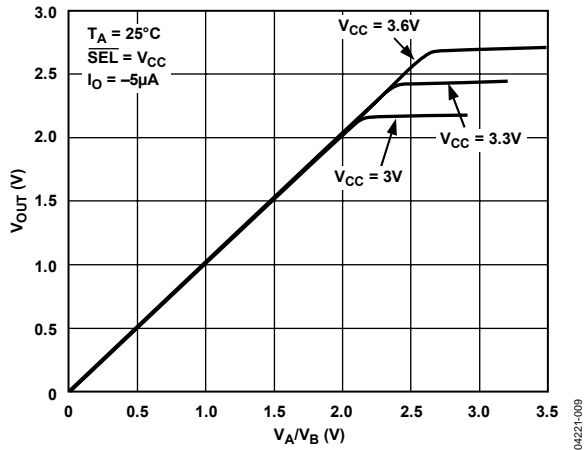

Figure 9. Pass Voltage vs. V_{CC}

04221-009

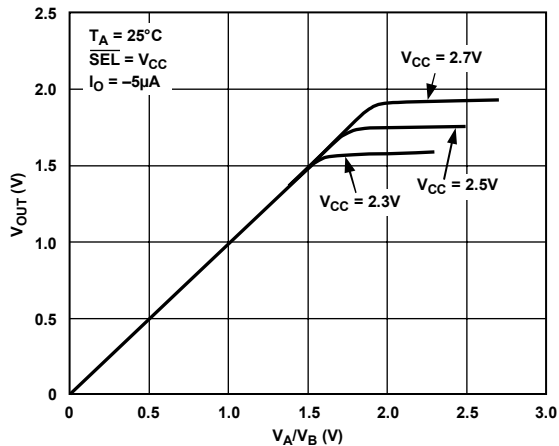

Figure 10. Pass Voltage vs. V_{CC}

04221-010

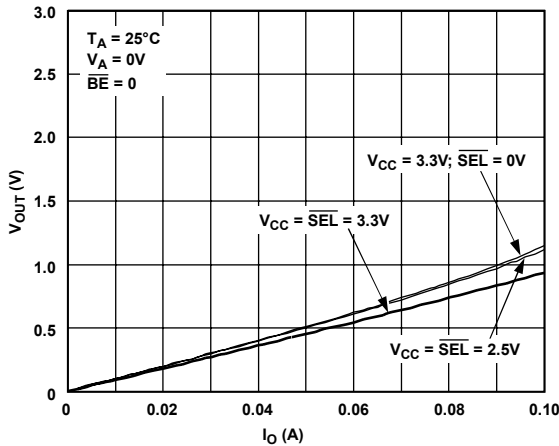

Figure 13. Output Low Characteristic

04221-013

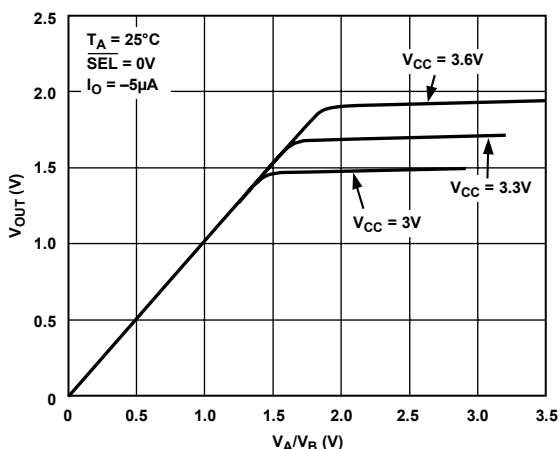

Figure 11. Pass Voltage vs. V_{CC}

04221-011

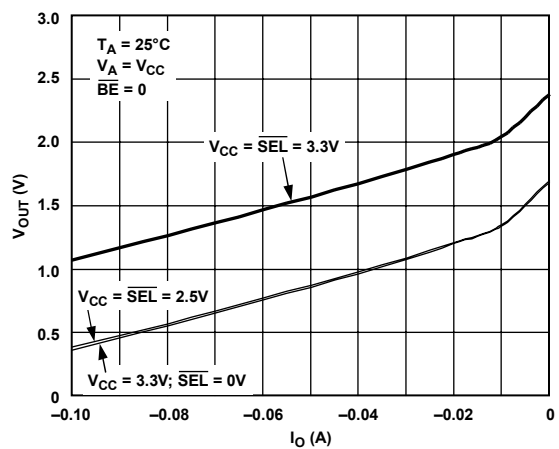

Figure 14. Output High Characteristic

04221-014

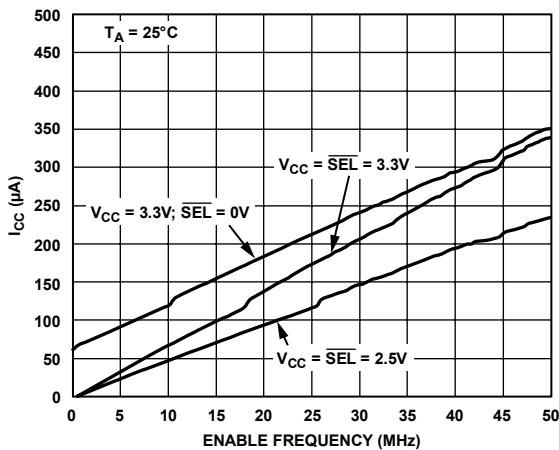

Figure 12. I_{CC} vs. Enable Frequency

04221-012

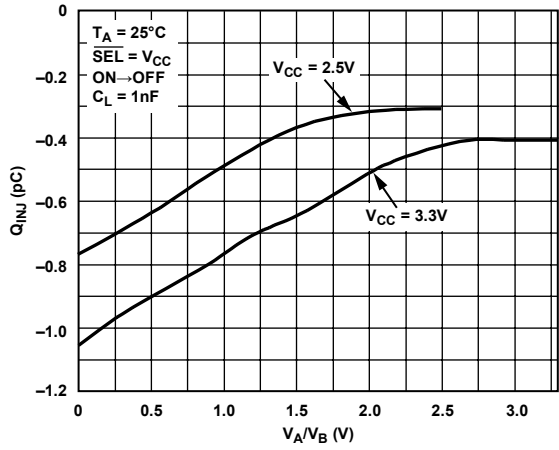

Figure 15. Charge Injection vs. Source Voltage

04221-015

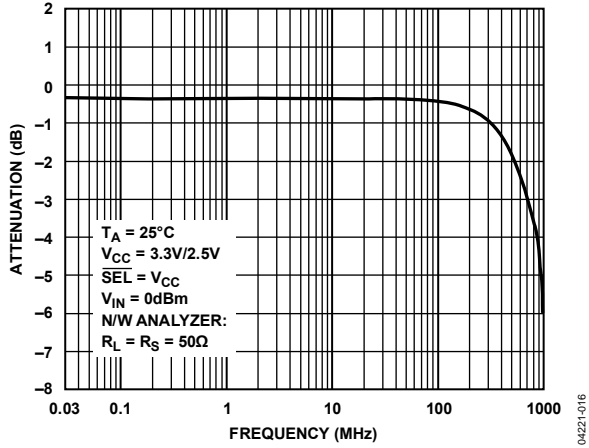

Figure 16. Bandwidth vs. Frequency

04221-016

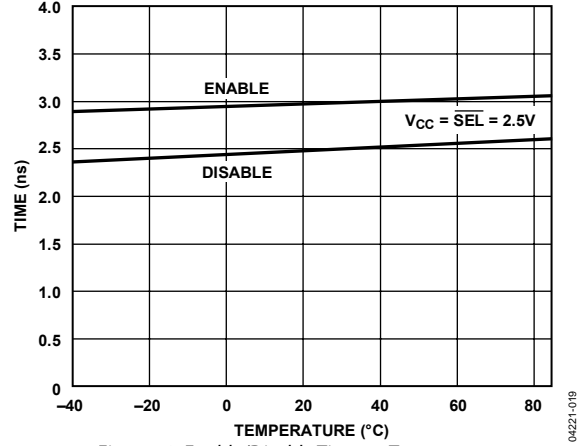

Figure 19. Enable/Disable Time vs. Temperature

04221-019

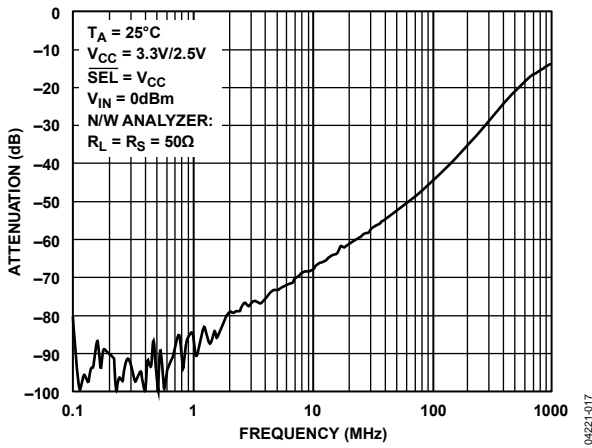

Figure 17. Off Isolation vs. Frequency

04221-017

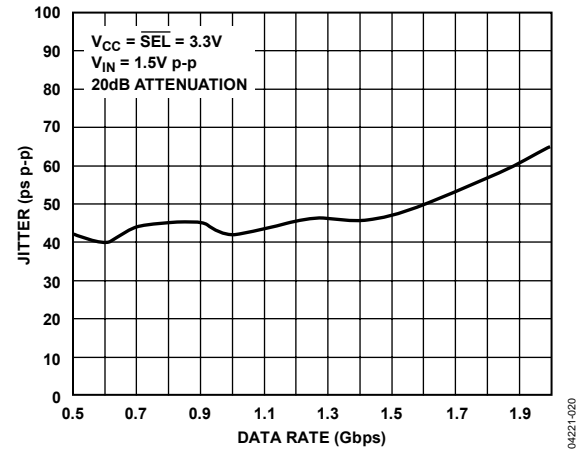

Figure 20. Jitter vs. Data Rate; PRBS 31

04221-020

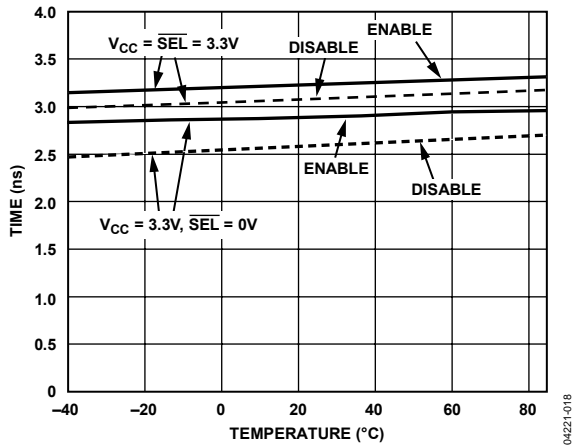

Figure 18. Enable/Disable Time vs. Temperature

04221-018

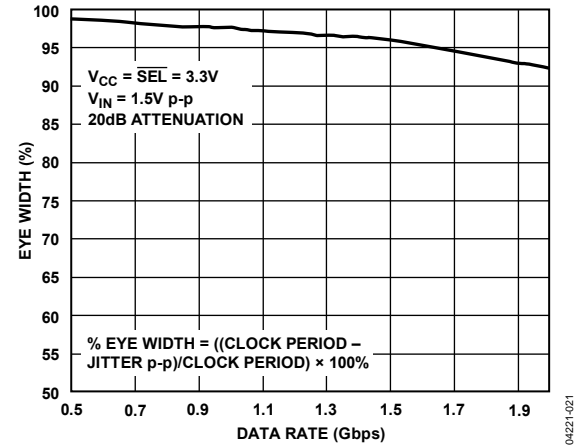

Figure 21. Eye Width vs. Data Rate; PRBS 31

04221-021

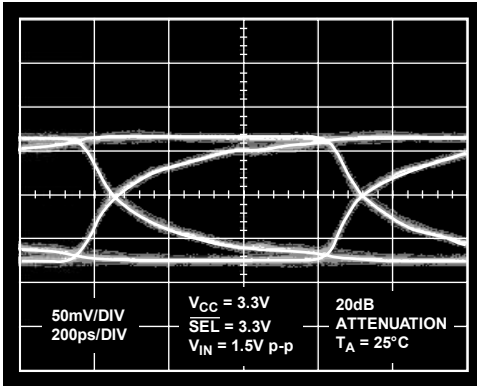

Figure 22. Eye Pattern; 1.5 Gbps, $V_{CC} = 3.3V$, PRBS 31

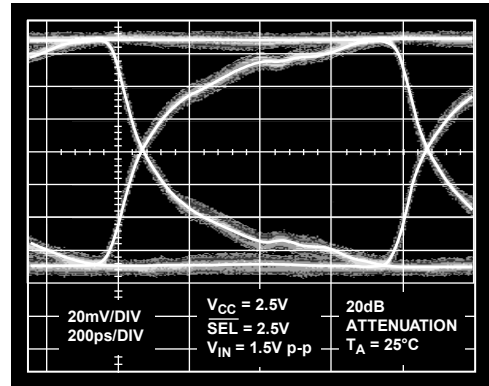

Figure 23. Eye Pattern; 1.244 Gbps, $V_{CC} = 2.5V$, PRBS 31

TERMINOLOGY

V_{CC}

Positive power supply voltage.

GND

Ground (0 V) reference.

V_{INH}

Minimum input voltage for Logic 1.

V_{INL}

Maximum input voltage for Logic 0.

I_I

Input leakage current at the control inputs.

I_{OZ}

Off state leakage current. It is the maximum leakage current at the switch pin in the off state.

I_{OL}

On state leakage current. It is the maximum leakage current at the switch pin in the on state.

V_P

Maximum pass voltage. The maximum pass voltage relates to the clamped output voltage of an NMOS device when the switch input voltage is equal to the supply voltage.

R_{ON}

Ohmic resistance offered by a switch in the on state. It is measured at a given voltage by forcing a specified amount of current through the switch.

C_x OFF

Off switch capacitance.

C_x ON

On switch capacitance.

C_{IN}

Control input capacitance. This consists of \overline{BE} and \overline{SEL} .

I_{CC}

Quiescent power supply current. This current represents the leakage current between the V_{CC} and ground pins. It is measured when all control inputs are at a logic high or low level and the switches are off.

ΔI_{CC}

Extra power supply current component for the \overline{BE} control input when the input is not driven at the supplies.

t_{PLH} , t_{PHL}

Data propagation delay through the switch in the on state. Propagation delay is related to the RC time constant $R_{ON} \times C_L$, where C_L is the load capacitance.

t_{PZH} , t_{PZL}

Bus enable times. These are the times taken to cross the V_T voltage at the switch output when the switch turns on in response to the control signal, \overline{BE} .

t_{PHZ} , t_{PLZ}

Bus disable times. These are the times taken to place the switch in the high impedance off state in response to the control signal. It is measured as the time taken for the output voltage to change by V_{Δ} from the original quiescent level, with reference to the logic level transition at the control input. Refer to Figure 26 for enable and disable times.

Max Data Rate

Maximum rate at which data can be passed through the switch.

Channel Jitter

Peak-to-peak value of the sum of the deterministic and random jitter of the switch channel.

TIMING MEASUREMENT INFORMATION

For the following load circuit and waveforms, the notation that is used is V_{IN} and V_{OUT} where

$$V_{IN} = V_A \text{ and } V_{OUT} = V_B \text{ or } V_{IN} = V_B \text{ and } V_{OUT} = V_A$$

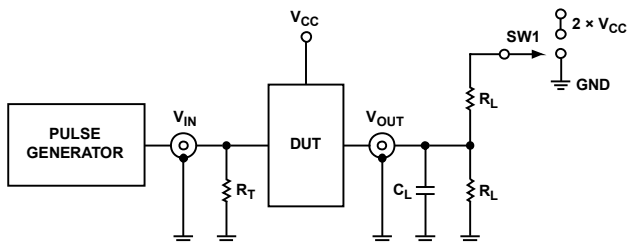

NOTES

1. PULSE GENERATOR FOR ALL PULSES: $t_R \leq 2.5\text{ns}$, $t_F \leq 2.5\text{ns}$, FREQUENCY $\leq 10\text{MHz}$.
2. C_L INCLUDES BOARD, STRAY, AND LOAD CAPACITANCES.
3. R_T IS THE TERMINATION RESISTOR, SHOULD BE EQUAL TO Z_{OUT} OF THE PULSE GENERATOR.

Figure 24. Load Circuit

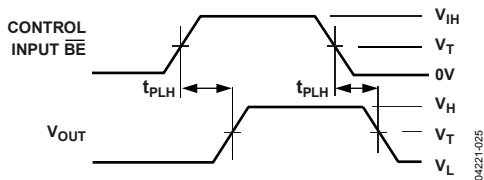

Figure 25. Propagation Delay

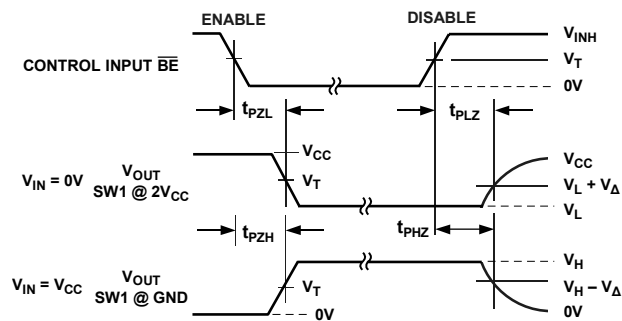

Figure 26. Enable and Disable Times

Table 5. Switch Position

| Test | S1 |
|--------------------|-------------------|
| t_{PLZ}, t_{PZL} | $2 \times V_{CC}$ |
| t_{PHZ}, t_{PZH} | GND |

Table 6. Test Conditions

| Symbol | $V_{CC} = 3.3\text{V} \pm 0.3\text{V}$ (SEL = V_{CC}) | $V_{CC} = 2.5\text{V} \pm 0.2\text{V}$ (SEL = V_{CC}) | $V_{CC} = 3.3\text{V} \pm 0.3\text{V}$ (SEL = 0V) | Unit |
|--------------|--|--|---|----------|
| R_L | 500 | 500 | 500 | Ω |
| V_{Δ} | 300 | 150 | 150 | mV |
| C_L | 50 | 30 | 30 | pF |
| V_T | 1.5 | 0.9 | 0.9 | V |

BUS SWITCH APPLICATIONS

MIXED VOLTAGE OPERATION, LEVEL TRANSLATION

Bus switches can provide an ideal solution for interfacing between mixed voltage systems. The ADG3241 is suitable for applications where voltage translation from 3.3 V technology to a lower voltage technology is needed. This device can translate from 3.3 V to 1.8 V, from 2.5 V to 1.8 V, or bidirectionally from 3.3 V directly to 2.5 V.

Figure 27 shows a block diagram of a typical application in which a user needs to interface between a 3.3 V ADC and a 2.5 V microprocessor. The microprocessor may not have 3.3 V tolerant inputs, therefore placing the ADG3241 between the two devices allows the devices to communicate easily. The bus switch directly connects the two blocks, thus introducing minimal propagation delay, timing skew, or noise.

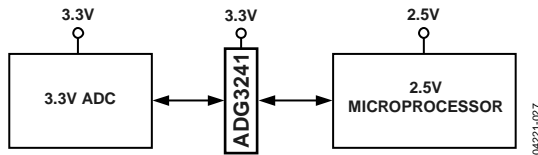

Figure 27. Level Translation Between a 3.3 V ADC and a 2.5 V Microprocessor

3.3 V TO 2.5 V TRANSLATION

When V_{CC} is 3.3 V ($\overline{SEL} = 3.3\text{ V}$) and the input signal range is 0 V to V_{CC} , the maximum output signal will be clamped to within a voltage threshold below the V_{CC} supply.

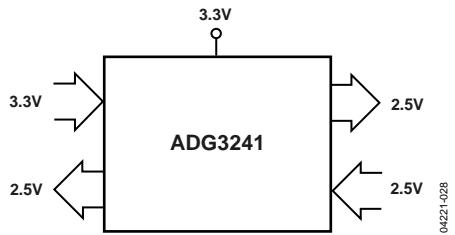

Figure 28. 3.3 V to 2.5 V Voltage Translation, $\overline{SEL} = V_{CC}$

In this case, the output is limited to 2.5 V, as shown in Figure 29. This device can be used for translation from 2.5 V to 3.3 V devices and also between two 3.3 V devices.

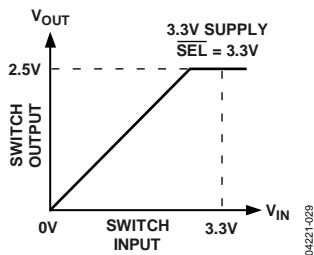

Figure 29. 3.3 V to 2.5 V Voltage Translation, $\overline{SEL} = V_{CC}$

2.5 V TO 1.8 V TRANSLATION

When V_{CC} is 2.5 V ($\overline{SEL} = 2.5\text{ V}$) and the input signal range is 0 V to V_{CC} , the maximum output signal is, as before, clamped to within a voltage threshold below the V_{CC} supply. In this case, the output is limited to approximately 1.8 V, as shown in Figure 31.

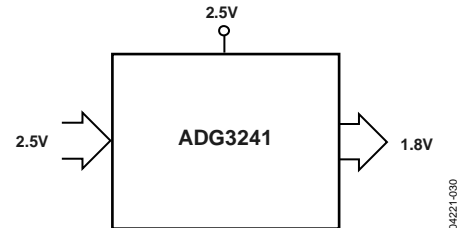

Figure 30. 2.5 V to 1.8 V Voltage Translation, $\overline{SEL} = 2.5\text{ V}_{CC}$

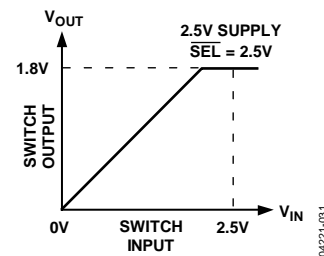

Figure 31. 2.5 V to 1.8 V Voltage Translation, $\overline{SEL} = V_{CC}$

3.3 V TO 1.8 V TRANSLATION

The ADG3241 offers the option of interfacing between a 3.3 V device and a 1.8 V device. This is possible through the use of the \overline{SEL} pin. The \overline{SEL} pin is an active low control pin. \overline{SEL} activates internal circuitry in the ADG3241 that allows voltage translation between 3.3 V devices and 1.8 V devices.

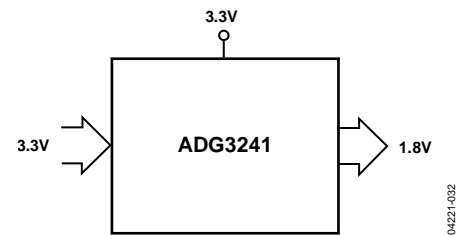

Figure 32. 3.3 V to 1.8 V Voltage Translation, $\overline{SEL} = 0\text{ V}$

When V_{CC} is 3.3 V and the input signal range is 0 V to V_{CC} , the maximum output signal is clamped to 1.8 V, as shown in Figure 32. To do this, the \overline{SEL} pin must be tied to Logic 0. If \overline{SEL} is unused, it should be tied directly to V_{CC} .

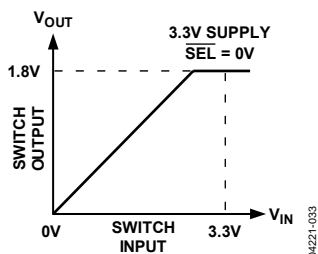

Figure 33. 3.3 V to 1.8 V Voltage Translation, $\overline{SEL} = 0 V$

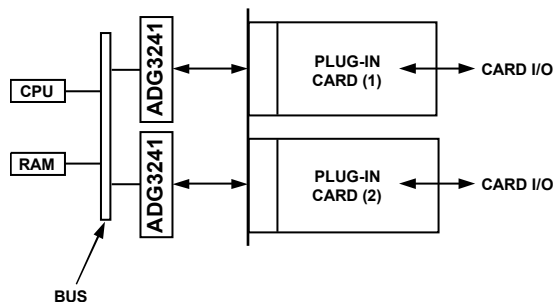

Figure 35. ADG3241 in a Hot Plug Application

BUS ISOLATION

A common requirement of bus architectures is low capacitance loading of the bus. Such systems require bus bridge devices that extend the number of loads on the bus without exceeding the specifications. Because the ADG3241 is designed specifically for applications that do not need drive yet require simple logic functions, it solves this requirement. The device isolates access to the bus, thus minimizing capacitance loading.

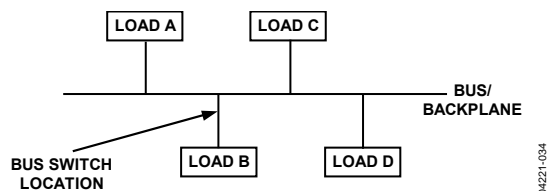

Figure 34. Location of Bus Switched in a Bus Isolation Application

HOT PLUG AND HOT SWAP ISOLATION

The ADG3241 is suitable for hot swap and hot plug applications. The output signal of the ADG3241 is limited to a voltage that is below the V_{CC} supply, as shown in Figure 29, Figure 31, and Figure 33. Therefore the switch acts like a buffer to take the impact from hot insertion, protecting vital and expensive chipsets from damage.

In hot plug applications, the system cannot be shut down when new hardware is being added. To overcome this, a bus switch can be positioned on the backplane between the bus devices and the hot plug connectors. The bus switch is turned off during hot plug. Figure 35 shows a typical example of this type of application.

There are many systems, such as docking stations, PCI boards for servers, and line cards for telecommunications switches, that require the ability to handle hot swapping. If the bus can be isolated prior to insertion or removal, there is more control over the hot swap event. This isolation can be achieved using bus switches. The bus switches are positioned on the hot swap card between the connector and the devices. During hot swap, the ground pin of the hot swap card must connect to the ground pin of the backplane before any other signal or power pins.

ANALOG SWITCHING

Bus switches can be used in many analog switching applications, such as video graphics. Bus switches can have lower on resistance, smaller on and off channel capacitance, and thus improved frequency performance over their analog counterparts.

The bus switch channel itself, consisting solely of an NMOS switch, limits the operating voltage (see Figure 4 for a typical plot), but in many cases this does not present an issue.

HIGH IMPEDANCE DURING POWER-UP/POWER-DOWN

To ensure the high impedance state during power-up or power-down, \overline{BE} should be tied to V_{CC} through a pull-up resistor; the minimum value of the resistor is determined by the current-sinking capability of the driver.

OUTLINE DIMENSIONS

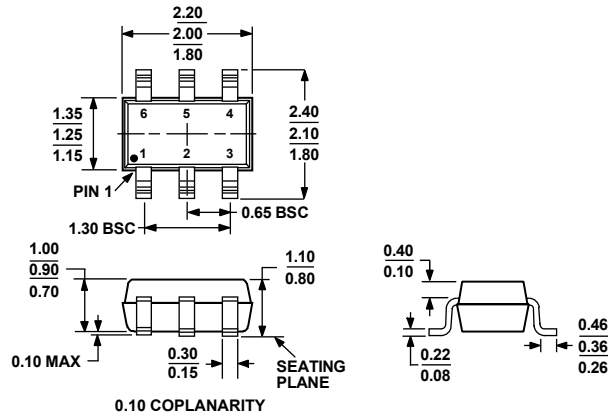

COMPLIANT TO JEDEC STANDARDS MO-203-AB

Figure 36. 6-Lead Thin Shrink Small Outline Transistor Package [SC70] (KS-6)
Dimensions shown in millimeters

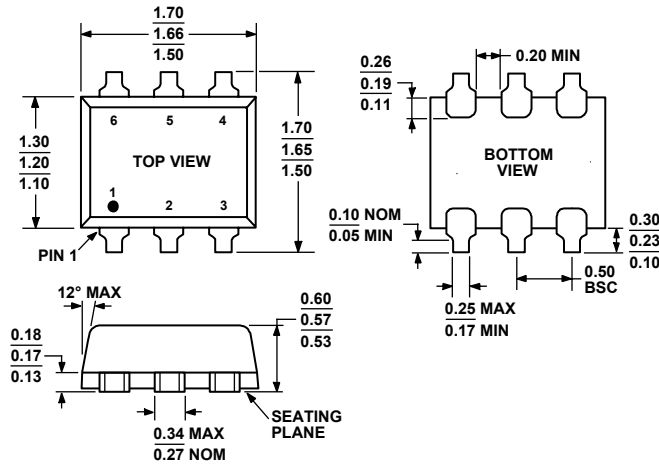

Figure 37. 6-Lead Small Outline Transistor Package [SOT-66] (RY-6-1)
Dimensions shown in millimeters

ORDERING GUIDE

| Model | Temperature Range | Package Description | Package Option | Branding |
|---------------------------------|-------------------|--|----------------|----------|
| ADG3241BKS-REEL7 | -40°C to +85°C | 6-Lead Thin Shrink Small Outline Transistor Package (SC70) | KS-6 | SKA |
| ADG3241BKS-500RL7 | -40°C to +85°C | 6-Lead Thin Shrink Small Outline Transistor Package (SC70) | KS-6 | SKA |
| ADG3241BKSZ-500RL7 ¹ | -40°C to +85°C | 6-Lead Thin Shrink Small Outline Transistor Package (SC70) | KS-6 | S19 |
| ADG3241BKSZ-REEL7 ¹ | -40°C to +85°C | 6-Lead Thin Shrink Small Outline Transistor Package (SC70) | KS-6 | S19 |
| ADG3241BKSZ-REEL ¹ | -40°C to +85°C | 6-Lead Thin Shrink Small Outline Transistor Package (SC70) | KS-6 | S19 |
| ADG3241BRYZ-REEL7 ¹ | -40°C to +85°C | 6-Lead Small Outline Transistor Package (SOT-66) | RY-6-1 | 00 |

¹ Z = Pb-free part.

NOTES

ADG3241

NOTES

Mouser Electronics

Authorized Distributor

Click to View Pricing, Inventory, Delivery & Lifecycle Information:

[Analog Devices Inc.:](#)

[ADG3241BKSZ-500RL7](#) [ADG3241BKSZ-REEL7](#)