





RED INDICATES ORIGINAL

DASH NO	CABLES ACCOMMODATED	ASSEMBLE PER
-23	275-3930, MICRODOT	TAI-127
-24	202-3934, MICRODOT	TAI-125
-24A	9530A5117, RAYCHEM	TAI-127
-27	202-3927, MICRODOT  73-1317911-1, SYLVANIA	TAI-125
-29	TWC-124-1A TWC-78-1	TAI-125
-30	8441, BELDEN  761A, W.E.CO.	TAI-125
-32	TRC-50-1	TAI-127
-33	TRC-75-1	TAI-127
-43	250-4044/250-4045 293-3930 MICRODOT	TAI-174
-45	10602, RAYCHEM	TAI-125
-47	M17/176-00002 	TAI-125
-49	TWAC-78-1F2 	TAI-125
-56	GC875GC1, GRUMMAN	TAI-174
-57	GC875GB1, GRUMMAN	TAI-174
-58	GC875TM24H, GRUMMAN	TAI-125

DATA CONTAINED IN THIS DOCUMENT IS PROPRIETARY TO TROMPETER ELECTRONICS INC. AND SHALL NOT BE DISCLOSED, COPIED OR USED FOR PROCUREMENT OR MANUFACTURE WITHOUT EXPRESS WRITTEN PERMISSION.

REVISIONS			310-0041	SH 1	
REV	EO	DESCRIPTION	DWN	APPROVED	DATE
N	12359	ADDED -45; SEE ECO	DBN	WM NAM.	3/16/98

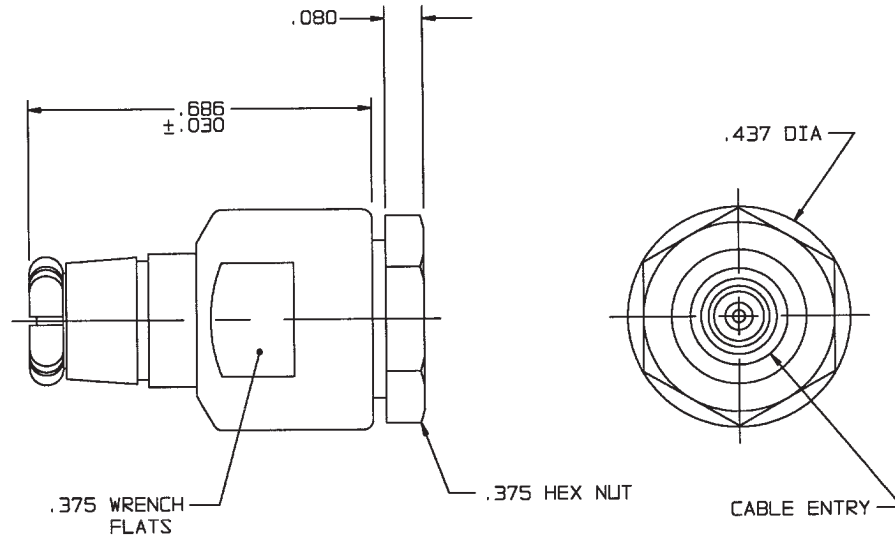

-29 SHOWN

INCH	MM
.005	0.13
.030	0.76
.080	2.03
.187	4.75
.375	9.53
.437	11.10
.686	17.42

 .187 LG JACKET SLITS MAY BE REQUIRED FOR EASE OF ASSY

 NOT WRENCH CRIMP

3. CONCENTRIC TWINAX/TRIAX SUBMINIATURE PUSH ON TRS PLUG

2. FINISH: TFS-1A (NICKEL)

1. ALL DIM ARE IN INCHES

QTY	DESCRIPTION		PART NUMBER	ITEM
	TOL UNLESS SPECIFIED .XX ± .XXX ± .005 .XXXX ± ANGLES ±		 PL153	
DWN	DBN	2/27/98		MATERIAL
CHK	WM	3-2-98		14949
ENGR				
APPR	WM.	3/16/98	SCALE 4/1	DATE 1/28/76
NEXT ASSY			DRAWING NO.	REV
			310-0041	N
			SHEET	1 OF 2

Mouser Electronics

Authorized Distributor

Click to View Pricing, Inventory, Delivery & Lifecycle Information:

[Cinch Connectivity Solutions:](#)

[PL153-47](#)