

# NTR4171P

## Power MOSFET

-30 V, -3.5 A, Single P-Channel, SOT-23

### Features

- Low  $R_{DS(on)}$  at Low Gate Voltage
- Low Threshold Voltage
- High Power and Current Handling Capability
- This is a Pb-Free Device

### Applications

- Load Switch
- Optimized for Battery and Load Management Applications in Portable Equipment like Cell Phones, PDA's, Media Players, etc.

### MAXIMUM RATINGS ( $T_J = 25^\circ\text{C}$ unless otherwise noted)

Parameter		Symbol	Value	Unit
Drain-to-Source Voltage		$V_{DSS}$	-30	V
Gate-to-Source Voltage		$V_{GS}$	$\pm 12$	V
Continuous Drain Current (Note 1)	Steady State	$T_A = 25^\circ\text{C}$	-2.2	A
			$T_A = 85^\circ\text{C}$	
	$t \leq 5$ s	$T_A = 25^\circ\text{C}$	-3.5	
Power Dissipation (Note 1)	Steady State	$T_A = 25^\circ\text{C}$	0.48	W
	$t \leq 5$ s		1.25	
Pulsed Drain Current	$t_p = 10$ $\mu\text{s}$	$I_{DM}$	-15.0	A
Operating Junction and Storage Temperature		$T_J, T_{stg}$	-55 to 150	$^\circ\text{C}$
Source Current (Body Diode)		$I_S$	-1.0	A
Lead Temperature for Soldering Purposes (1/8" from case for 10 s)		$T_L$	260	$^\circ\text{C}$

Stresses exceeding those listed in the Maximum Ratings table may damage the device. If any of these limits are exceeded, device functionality should not be assumed, damage may occur and reliability may be affected.

### THERMAL RESISTANCE RATINGS

Parameter	Symbol	Max	Unit
Junction-to-Ambient - Steady State (Note 1)	$R_{\theta JA}$	260	$^\circ\text{C}/\text{W}$
Junction-to-Ambient - $t \leq 10$ s (Note 1)	$R_{\theta JA}$	100	

1. Surface-mounted on FR4 board using 1 in sq pad size (Cu area = 1.127 in sq [2 oz] including traces)



ON Semiconductor®

[www.onsemi.com](http://www.onsemi.com)

$V_{(BR)DSS}$	$R_{DS(on)}$ MAX	$I_D$ MAX
-30 V	75 m $\Omega$ @ -10 V	-2.2 A
	110 m $\Omega$ @ -4.5 V	-1.8 A
	150 m $\Omega$ @ -2.5 V	-1.0 A

### P-CHANNEL MOSFET

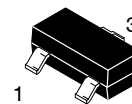
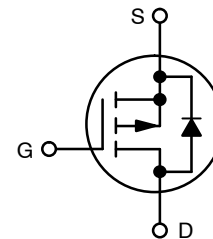

SOT-23  
CASE 318  
STYLE 21

### MARKING DIAGRAM/ PIN ASSIGNMENT

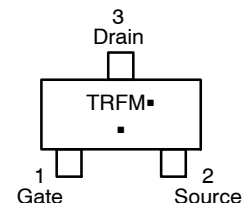

TRF = Specific Device Code  
M = Date Code  
▪ = Pb-Free Package  
(Note: Microdot may be in either location)

### ORDERING INFORMATION

Device	Package	Shipping†
NTR4171PT1G	SOT-23 (Pb-Free)	3000/Tape & Reel
NTR4171PT3G	SOT-23 (Pb-Free)	10000/Tape & Reel

†For information on tape and reel specifications, including part orientation and tape sizes, please refer to our Tape and Reel Packaging Specification Brochure, BRD8011/D.

# NTR4171P

## MOSFET ELECTRICAL CHARACTERISTICS ( $T_J = 25^\circ\text{C}$ unless otherwise noted)

Parameter	Symbol	Test Condition	Min	Typ	Max	Units
-----------	--------	----------------	-----	-----	-----	-------

### OFF CHARACTERISTICS

Drain-to-Source Breakdown Voltage	$V_{(BR)DSS}$	$V_{GS} = 0\text{ V}, I_D = -250\ \mu\text{A}$	-30			V
Drain-to-Source Breakdown Voltage Temperature Coefficient	$V_{(BR)DSS}/T_J$	$I_D = -250\ \mu\text{A}$ , Reference to $25^\circ\text{C}$		24		$\text{mV}/^\circ\text{C}$
Zero Gate Voltage Drain Current	$I_{DSS}$	$V_{GS} = 0\text{ V}, V_{DS} = -24\text{ V}, T_J = 25^\circ\text{C}$ $V_{GS} = 0\text{ V}, V_{DS} = -24\text{ V}, T_J = 85^\circ\text{C}$			-1.0 -5.0	$\mu\text{A}$
Gate-to-Source Leakage Current	$I_{GSS}$	$V_{DS} = 0\text{ V}, V_{GS} = \pm 12\text{ V}$			$\pm 0.1$	$\mu\text{A}$

### ON CHARACTERISTICS (Note 3)

Gate Threshold Voltage	$V_{GS(TH)}$	$V_{GS} = V_{DS}, I_D = -250\ \mu\text{A}$	-0.7	-1.15	-1.4	V
Negative Threshold Temperature Coefficient	$V_{GS(TH)}/T_J$			3.5		$\text{mV}/^\circ\text{C}$
Drain-to-Source On-Resistance	$R_{DS(on)}$	$V_{GS} = -10\text{ V}, I_D = -2.2\text{ A}$		50	75	$\text{m}\Omega$
		$V_{GS} = -4.5\text{ V}, I_D = -1.8\text{ A}$		60	110	
		$V_{GS} = -2.5\text{ V}, I_D = -1.0\text{ A}$		90	150	
Forward Transconductance	$g_{FS}$	$V_{DS} = -5.0\text{ V}, I_D = -2.2\text{ A}$		7.0		S

### CHARGES, CAPACITANCES AND GATE RESISTANCE

Input Capacitance	$C_{iss}$	$V_{GS} = 0\text{ V}, f = 1.0\text{ MHz},$ $V_{DS} = -15\text{ V}$		720		$\text{pF}$
Output Capacitance	$C_{oss}$			95		
Reverse Transfer Capacitance	$C_{rss}$			65		
Total Gate Charge	$Q_{G(TOT)}$	$V_{GS} = -10\text{ V}, V_{DS} = -15\text{ V},$ $I_D = -3.5\text{ A}$		15.6		$\text{nC}$
Threshold Gate Charge	$Q_{G(TH)}$			0.7		
Gate-to-Source Charge	$Q_{GS}$			1.6		
Gate-to-Drain Charge	$Q_{GD}$			2.6		
Total Gate Charge	$Q_{G(TOT)}$	$V_{GS} = -4.5\text{ V}, V_{DS} = -15\text{ V},$ $I_D = -3.5\text{ A}$		7.4		$\text{nC}$
Threshold Gate Charge	$Q_{G(TH)}$			0.7		
Gate-to-Source Charge	$Q_{GS}$			1.6		
Gate-to-Drain Charge	$Q_{GD}$			2.6		
Gate Resistance	$R_G$			6.1		$\Omega$

### SWITCHING CHARACTERISTICS, $V_{GS} = 4.5\text{ V}$ (Note 4)

Turn-On Delay Time	$t_{d(on)}$	$V_{GS} = -10\text{ V}, V_{DS} = -15\text{ V},$ $I_D = -3.5\text{ A}, R_G = 6\ \Omega$		8.0		ns
Rise Time	$t_r$			11		
Turn-Off Delay Time	$t_{d(off)}$			32		
Fall Time	$t_f$			14		
Turn-On Delay Time	$t_{d(on)}$	$V_{GS} = -4.5\text{ V}, V_{DS} = -15\text{ V},$ $I_D = -3.5\text{ A}, R_G = 6\ \Omega$		9.0		ns
Rise Time	$t_r$			16		
Turn-Off Delay Time	$t_{d(off)}$			25		
Fall Time	$t_f$			22		

### DRAIN-SOURCE DIODE CHARACTERISTICS

Forward Diode Voltage	$V_{SD}$	$V_{GS} = 0\text{ V}, I_S = -1.0\text{ A}, T_J = 25^\circ\text{C}$		-0.8	-1.2	V
Reverse Recovery Time	$t_{RR}$	$V_{GS} = 0\text{ V}, I_S = -1.0\text{ A},$ $dI_{SD}/dt = 100\text{ A}/\mu\text{s}$		14		ns
Charge Time	$t_a$			10		
Discharge Time	$t_b$			4.0		
Reverse Recovery Charge	$Q_{RR}$			8.0		$\text{nC}$

Product parametric performance is indicated in the Electrical Characteristics for the listed test conditions, unless otherwise noted. Product performance may not be indicated by the Electrical Characteristics if operated under different conditions.

2. Surface-mounted on FR4 board using 1 in sq pad size (Cu area = 1.127 in sq [2 oz] including traces)

3. Pulse Test: Pulse Width  $\leq 300\ \mu\text{s}$ , Duty Cycle  $\leq 2\%$

4. Switching characteristics are independent of operating junction temperatures

TYPICAL CHARACTERISTICS

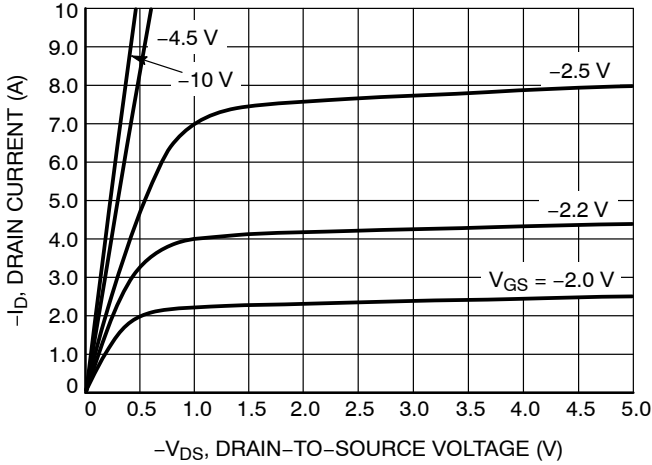

Figure 1. On-Region Characteristics

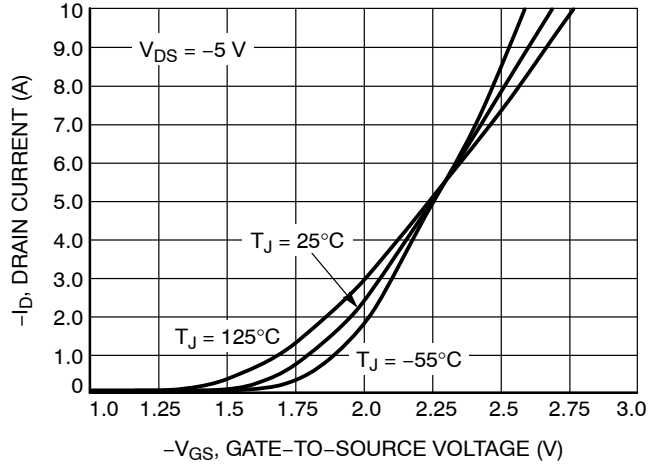

Figure 2. Transfer Characteristics

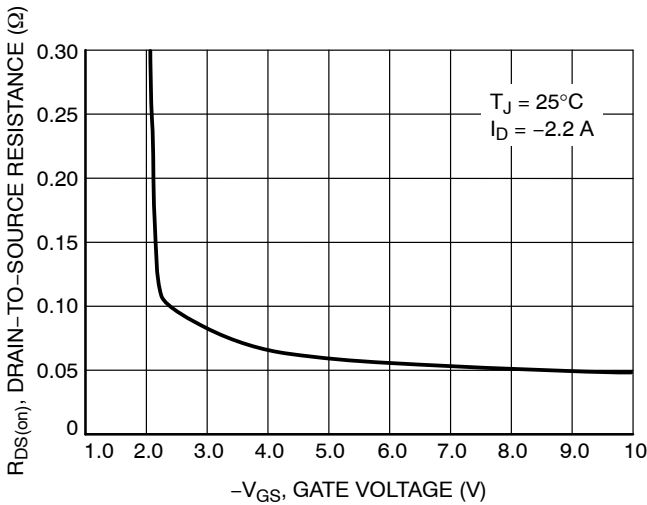

Figure 3. On-Resistance vs. Gate-to-Source Voltage

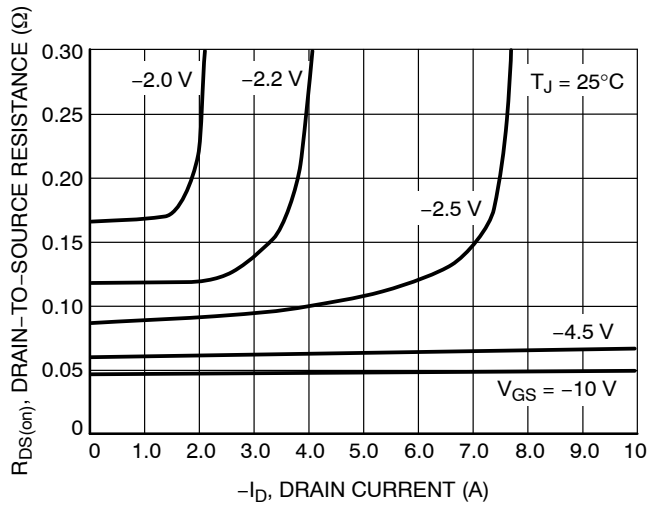

Figure 4. On-Resistance vs. Drain Current and Gate Voltage

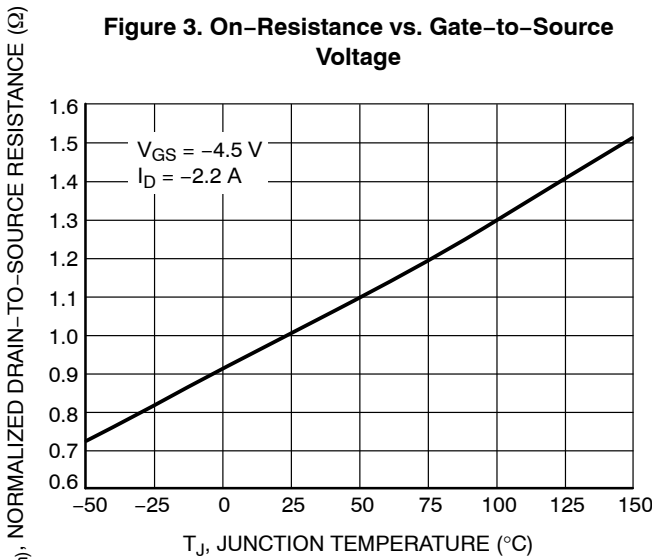

Figure 5. On-Resistance Variation with Temperature

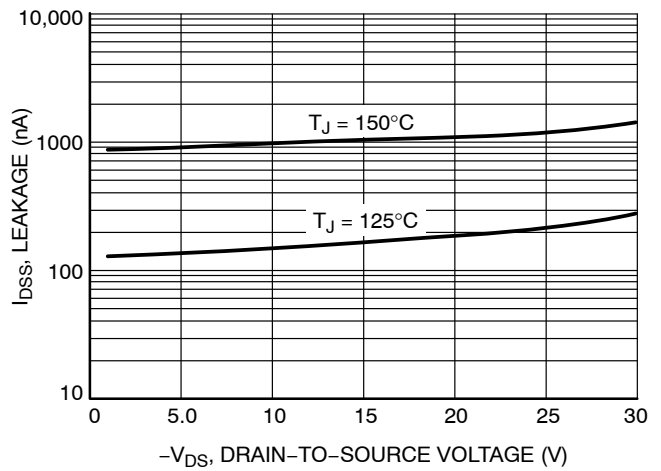

Figure 6. Drain-to-Source Leakage Current vs. Voltage

TYPICAL CHARACTERISTICS

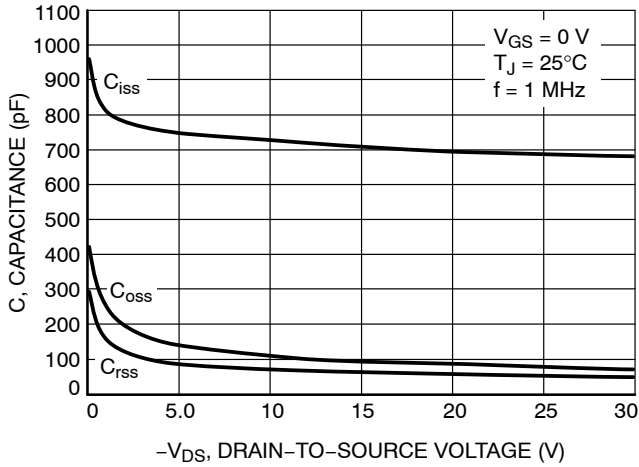

Figure 7. Capacitance Variation

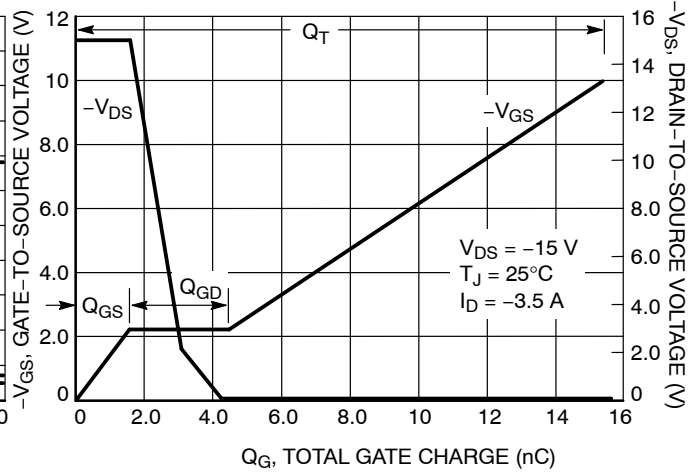

Figure 8. Gate-to-Source and Drain-to-Source Voltage vs. Total Charge

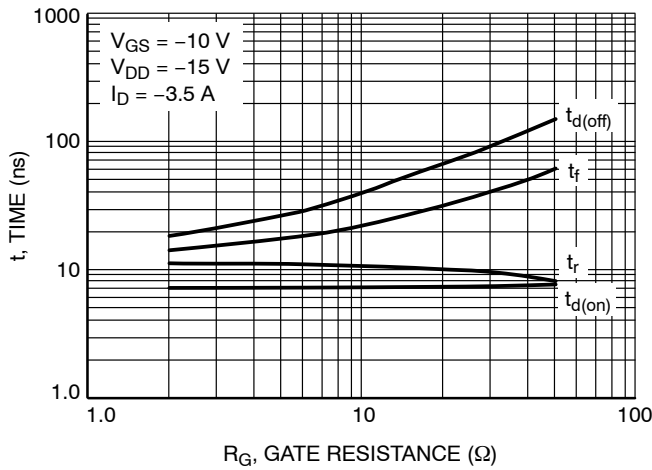

Figure 9. Resistive Switching Time Variation vs. Gate Resistance

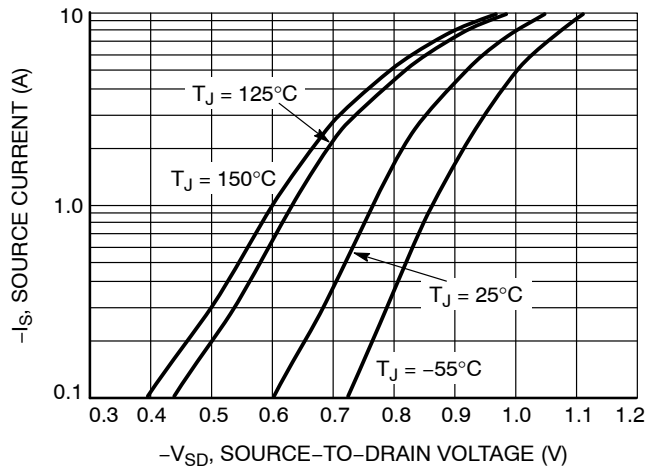

Figure 10. Diode Forward Voltage vs. Current

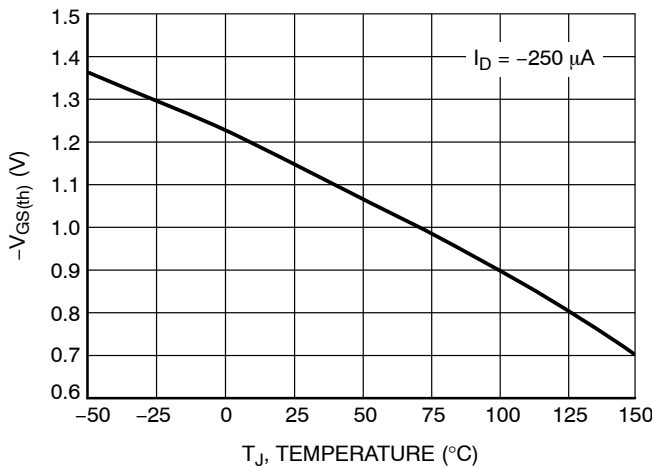

Figure 11. Threshold Voltage

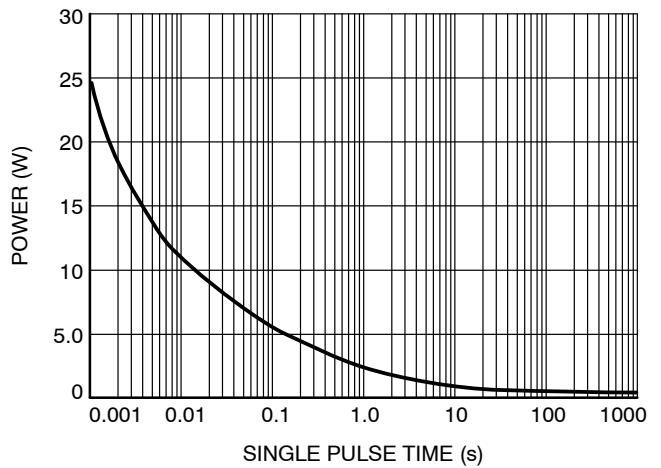

Figure 12. Single Pulse Maximum Power Dissipation

# NTR4171P

## TYPICAL CHARACTERISTICS

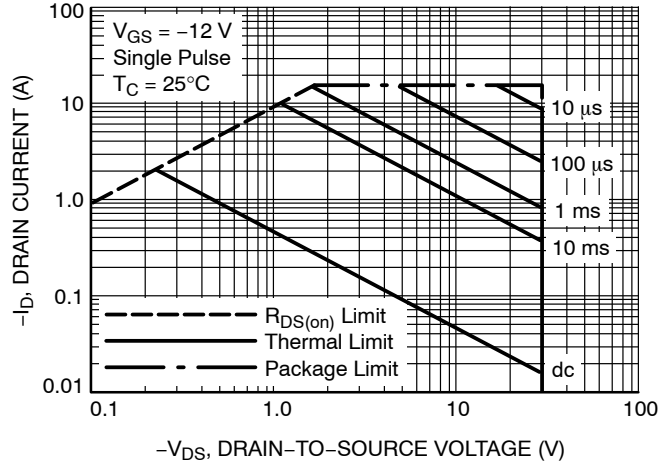

Figure 13. Maximum Rated Forward Biased Safe Operating Area

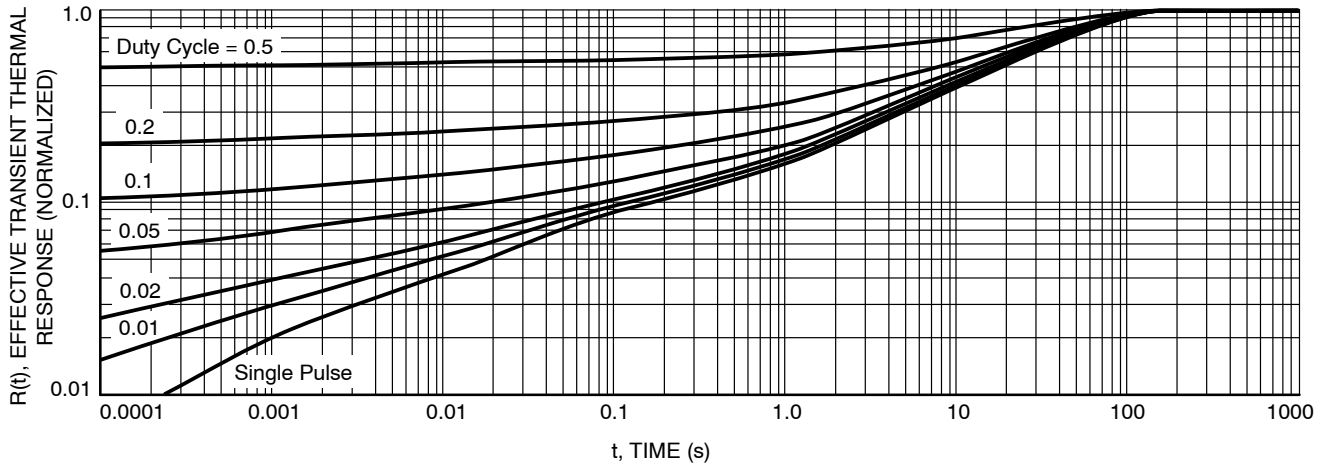
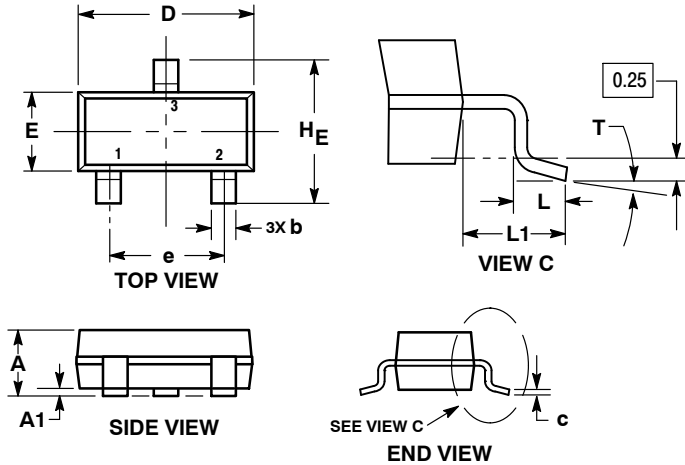

Figure 14. FET Thermal Response

# NTR4171P

## PACKAGE DIMENSIONS

SOT-23 (TO-236)  
CASE 318-08  
ISSUE AR



**NOTES:**

1. DIMENSIONING AND TOLERANCING PER ASME Y14.5M, 1994.
2. CONTROLLING DIMENSION: MILLIMETERS.
3. MAXIMUM LEAD THICKNESS INCLUDES LEAD FINISH. MINIMUM LEAD THICKNESS IS THE MINIMUM THICKNESS OF THE BASE MATERIAL.
4. DIMENSIONS D AND E DO NOT INCLUDE MOLD FLASH, PROTRUSIONS, OR GATE BURRS.

DIM	MILLIMETERS			INCHES		
	MIN	NOM	MAX	MIN	NOM	MAX
A	0.89	1.00	1.11	0.035	0.039	0.044
A1	0.01	0.06	0.10	0.000	0.002	0.004
b	0.37	0.44	0.50	0.015	0.017	0.020
c	0.08	0.14	0.20	0.003	0.006	0.008
D	2.80	2.90	3.04	0.110	0.114	0.120
E	1.20	1.30	1.40	0.047	0.051	0.055
e	1.78	1.90	2.04	0.070	0.075	0.080
L	0.30	0.43	0.55	0.012	0.017	0.022
L1	0.35	0.54	0.69	0.014	0.021	0.027
HE	2.10	2.40	2.64	0.083	0.094	0.104
T	0°	---	10°	0°	---	10°

**STYLE 21:**

1. GATE
2. SOURCE
3. DRAIN

### RECOMMENDED SOLDERING FOOTPRINT\*

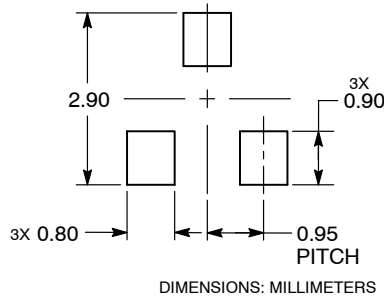

\*For additional information on our Pb-Free strategy and soldering details, please download the ON Semiconductor Soldering and Mounting Techniques Reference Manual, SOLDERM/D.

ON Semiconductor and are trademarks of Semiconductor Components Industries, LLC dba ON Semiconductor or its subsidiaries in the United States and/or other countries. ON Semiconductor owns the rights to a number of patents, trademarks, copyrights, trade secrets, and other intellectual property. A listing of ON Semiconductor's product/patent coverage may be accessed at [www.onsemi.com/site/pdf/Patent-Marking.pdf](http://www.onsemi.com/site/pdf/Patent-Marking.pdf). ON Semiconductor reserves the right to make changes without further notice to any products herein. ON Semiconductor makes no warranty, representation or guarantee regarding the suitability of its products for any particular purpose, nor does ON Semiconductor assume any liability arising out of the application or use of any product or circuit, and specifically disclaims any and all liability, including without limitation special, consequential or incidental damages. Buyer is responsible for its products and applications using ON Semiconductor products, including compliance with all laws, regulations and safety requirements or standards, regardless of any support or applications information provided by ON Semiconductor. "Typical" parameters which may be provided in ON Semiconductor data sheets and/or specifications can and do vary in different applications and actual performance may vary over time. All operating parameters, including "Typicals" must be validated for each customer application by customer's technical experts. ON Semiconductor does not convey any license under its patent rights nor the rights of others. ON Semiconductor products are not designed, intended, or authorized for use as a critical component in life support systems or any FDA Class 3 medical devices or medical devices with a same or similar classification in a foreign jurisdiction or any devices intended for implantation in the human body. Should Buyer purchase or use ON Semiconductor products for any such unintended or unauthorized application, Buyer shall indemnify and hold ON Semiconductor and its officers, employees, subsidiaries, affiliates, and distributors harmless against all claims, costs, damages, and expenses, and reasonable attorney fees arising out of, directly or indirectly, any claim of personal injury or death associated with such unintended or unauthorized use, even if such claim alleges that ON Semiconductor was negligent regarding the design or manufacture of the part. ON Semiconductor is an Equal Opportunity/Affirmative Action Employer. This literature is subject to all applicable copyright laws and is not for resale in any manner.

### PUBLICATION ORDERING INFORMATION

**LITERATURE FULFILLMENT:**  
Literature Distribution Center for ON Semiconductor  
19521 E. 32nd Pkwy, Aurora, Colorado 80011 USA  
**Phone:** 303-675-2175 or 800-344-3860 Toll Free USA/Canada  
**Fax:** 303-675-2176 or 800-344-3867 Toll Free USA/Canada  
**Email:** [orderlit@onsemi.com](mailto:orderlit@onsemi.com)

**N. American Technical Support:** 800-282-9855 Toll Free  
USA/Canada  
**Europe, Middle East and Africa Technical Support:**  
Phone: 421 33 790 2910  
**Japan Customer Focus Center**  
Phone: 81-3-5817-1050

**ON Semiconductor Website:** [www.onsemi.com](http://www.onsemi.com)  
**Order Literature:** <http://www.onsemi.com/orderlit>

For additional information, please contact your local Sales Representative

# Mouser Electronics

Authorized Distributor

Click to View Pricing, Inventory, Delivery & Lifecycle Information:

[ON Semiconductor:](#)

[NTR4171PT1G](#)