

3950X SERIES
3.50mm HEADERS

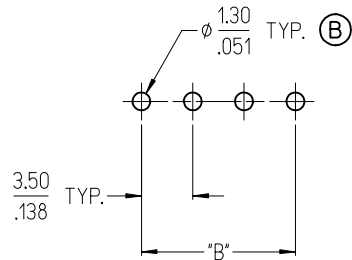

3952X & 3954X SERIES
5.00mm HEADERS
5.00mm FIXED

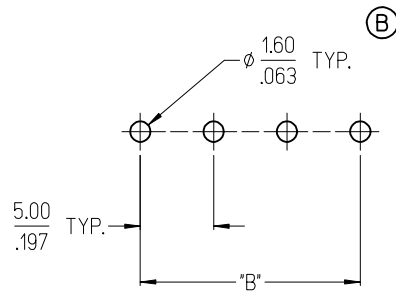

3953X SERIES
5.08mm HEADERS

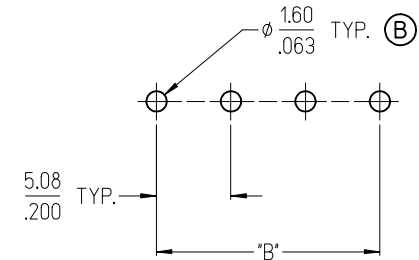

3951X SERIES
3.81mm HEADERS

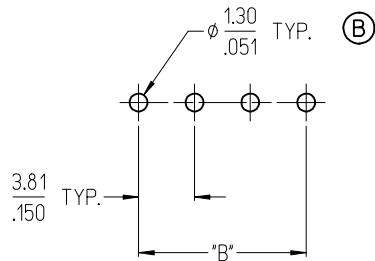

3954X SERIES
5.00mm FIXED

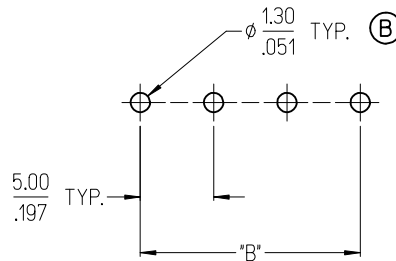

3954X SERIES
5.08mm FIXED

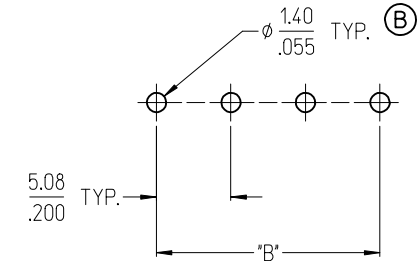

NOTES:

- REFER TO INDIVIDUAL PRODUCT SALES DRAWINGS FOR "B" DIMENSION.
- DOES NOT APPLY TO DUAL LEVEL HEADERS, SERIES 39528 AND 39538.
- TYP. = TYPICAL.

TOLERANCES			
MM	TOL	INCH	TOL
0-6	±0.25	0-.24	±.010
>6-30	±0.40	.24-1.18	±.016
>30-120	±0.50	1.18-4.76	±.020
>120	±0.80	>4.76	±.031

REVISED DOC TOL
EC NO: IPG2017-0881
DRAWN: VASUTHKARP 2017/03/23
CHKD:
APPR: BRUPERT 2017/04/18
REV DESCRIPTION

QUALITY SYMBOLS
▽=0
▽=0

GENERAL TOLERANCES (UNLESS SPECIFIED)

	mm	INCH
4 PLACES	±---	±---
3 PLACES	±---	±---
2 PLACES	±---	±---
1 PLACE	±---	±---
ANGULAR ±---°		

DRAFT WHERE APPLICABLE
MUST REMAIN
WITHIN DIMENSIONS

DIMENSION STYLE
MM/IN

DRAWN BY	DATE
C. YORK	2006/08/25
CHECKED BY	DATE
J. MACNEIL	2006/08/25
APPROVED BY	DATE
J. MACNEIL	2006/08/25

MATERIAL NO. --

SCALE DESIGN UNITS INCH

THIRD ANGLE PROJECTION

TITLE
RECOMMENDED PCB LAYOUT FOR ESE TERMINAL BLOCKS

molex MOLEX INCORPORATED

DOCUMENT NO. SD-39501-002

SHEET NO. 1 OF 1

THIS DRAWING CONTAINS INFORMATION THAT IS PROPRIETARY TO MOLEX INCORPORATED AND SHOULD NOT BE USED WITHOUT WRITTEN PERMISSION

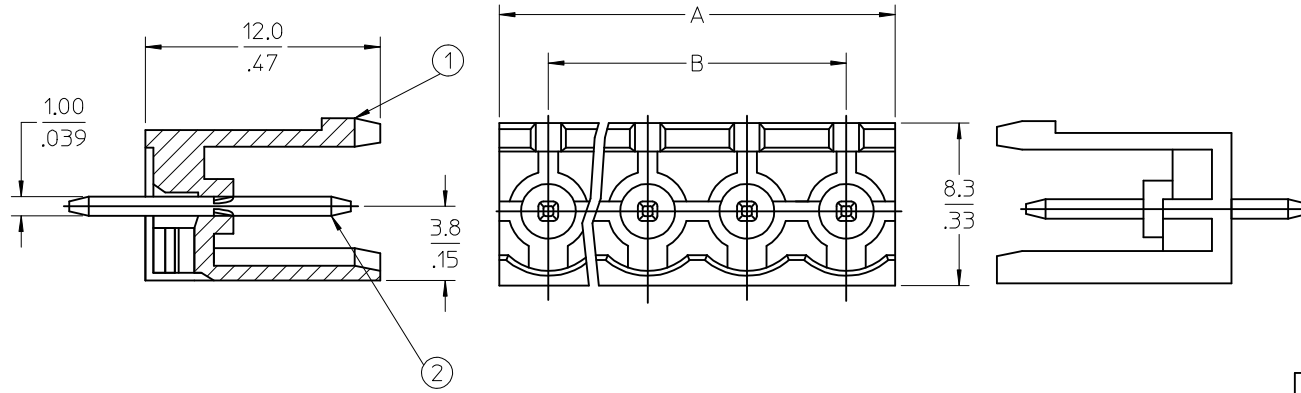
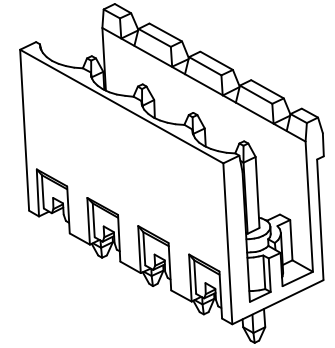
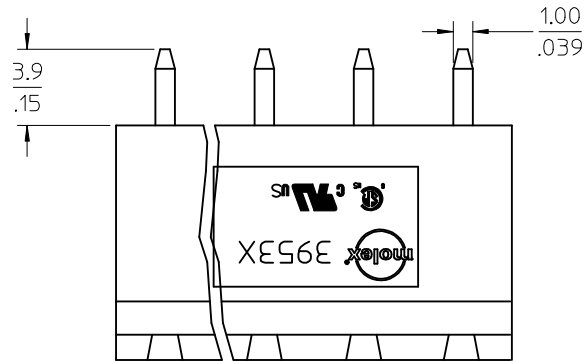

SPECIFICATIONS:

1. Material:
 - (1). Body: PA66
 - (2). Pin: Brass
2. Wire range: N/A
3. Electrical rating: 300V, 15A.
4. Wire strip length: N/A
5. Operating temperature: -40C to +105C.
6. Max torque: N/A
7. Insulation resistance: DC 500V, 500M.
8. Dielectric withstand: AC 2500V for 1 minute.
9. Breakdown voltage: 4000V.
10. A = (N x P)
11. B = (N - 1) x P
12. P (PITCH) = 5.08mm (.200").
13. N = Number of positions available 2 through 24.

TOLERANCES			
MM	TOL	INCH	TOL
0-6	±0.25	0-.24	±.010
>6-30	±0.40	.24-1.18	±.016
>30-120	±0.50	1.18-4.76	±.020
>120	±0.80	>4.76	±.031

REVISED DOC TOL EC NO: IFC2017-0881 DRW: LFRADDOREWS 2017/03/23 CHKD: APPR: BRUPERT 2017/04/18 REV	QUALITY SYMBOLS	GENERAL TOLERANCES (UNLESS SPECIFIED)	DIMENSION STYLE	SCALE	DESIGN UNITS	THIRD ANGLE PROJECTION	
	▼=0 ▽=0	mm INCH 4 PLACES ±--- ±--- 3 PLACES ±--- ±--- 2 PLACES ±--- ±--- 1 PLACE ±--- ±--- ANGULAR ±---°	MM/IN	4:1	INCH	DRAWN BY LROTHAUS DATE 12/6/05 CHECKED BY C. YORK DATE 01/06/06 APPROVED BY DATE	
		DRAFT WHERE APPLICABLE MUST REMAIN WITHIN DIMENSIONS	SEE CHART	MATERIAL NO.	DOCUMENT NO.	TITLE 5.08MM, EURO HEADER, VERTICAL, OPEN END	
	A1			SIZE B		MOLEX INCORPORATED SD-39531-003	SHEET NO. 1 OF 1

Description	Circuit size	Material Numbers												Dimensional Information						
		Black						Green						Dim A		Dim B				
		100% Tin			50% Gold			100% Tin			50% Gold			mm	inch	mm	inch			
		Printing Options			Printing Options			Printing Options			Printing Options									
None 10AV 11AV			None 10AV 11AV			None 10AV 11AV			None 10AV 11AV											
5.08mm, Euro Header, Vertical, Open End	2	395310002	395310302	395310402	395310502	395310602	395310702	395310802	395310902	395311002	395311102	395311202	395311302	395311402	395311502	395311602	10.16	0.400	5.08	0.200
5.08mm, Euro Header, Vertical, Open End	3	395310003	395310303	395310403	395310503	395310603	395310703	395310803	395310903	395311003	395311103	395311203	395311303	395311403	395311503	395311603	15.24	0.600	10.16	0.400
5.08mm, Euro Header, Vertical, Open End	4	395310004	395310304	395310404	395310504	395310604	395310704	395310804	395310904	395311004	395311104	395311204	395311304	395311404	395311504	395311604	20.32	0.800	15.24	0.600
5.08mm, Euro Header, Vertical, Open End	5	395310005	395310305	395310405	395310505	395310605	395310705	395310805	395310905	395311005	395311105	395311205	395311305	395311405	395311505	395311605	25.40	1.000	20.32	0.800
5.08mm, Euro Header, Vertical, Open End	6	395310006	395310306	395310406	395310506	395310606	395310706	395310806	395310906	395311006	395311106	395311206	395311306	395311406	395311506	395311606	30.48	1.200	25.40	1.000
5.08mm, Euro Header, Vertical, Open End	7	395310007	395310307	395310407	395310507	395310607	395310707	395310807	395310907	395311007	395311107	395311207	395311307	395311407	395311507	395311607	35.56	1.400	30.48	1.200
5.08mm, Euro Header, Vertical, Open End	8	395310008	395310308	395310408	395310508	395310608	395310708	395310808	395310908	395311008	395311108	395311208	395311308	395311408	395311508	395311608	40.64	1.600	35.56	1.400
5.08mm, Euro Header, Vertical, Open End	9	395310009	395310309	395310409	395310509	395310609	395310709	395310809	395310909	395311009	395311109	395311209	395311309	395311409	395311509	395311609	45.72	1.800	40.64	1.600
5.08mm, Euro Header, Vertical, Open End	10	395310010	395310310	395310410	395310510	395310610	395310710	395310810	395310910	395311010	395311110	395311210	395311310	395311410	395311510	395311610	50.80	2.000	45.72	1.800
5.08mm, Euro Header, Vertical, Open End	11	395310011	395310311	395310411	395310511	395310611	395310711	395310811	395310911	395311011	395311111	395311211	395311311	395311411	395311511	395311611	55.88	2.200	50.80	2.000
5.08mm, Euro Header, Vertical, Open End	12	395310012	395310312	395310412	395310512	395310612	395310712	395310812	395310912	395311012	395311112	395311212	395311312	395311412	395311512	395311612	60.96	2.400	55.88	2.200
5.08mm, Euro Header, Vertical, Open End	13	395310013	395310313	395310413	395310513	395310613	395310713	395310813	395310913	395311013	395311113	395311213	395311313	395311413	395311513	395311613	66.04	2.600	60.96	2.400
5.08mm, Euro Header, Vertical, Open End	14	395310014	395310314	395310414	395310514	395310614	395310714	395310814	395310914	395311014	395311114	395311214	395311314	395311414	395311514	395311614	71.12	2.800	66.04	2.600
5.08mm, Euro Header, Vertical, Open End	15	395310015	395310315	395310415	395310515	395310615	395310715	395310815	395310915	395311015	395311115	395311215	395311315	395311415	395311515	395311615	76.20	3.000	71.12	2.800
5.08mm, Euro Header, Vertical, Open End	16	395310016	395310316	395310416	395310516	395310616	395310716	395310816	395310916	395311016	395311116	395311216	395311316	395311416	395311516	395311616	81.28	3.200	76.20	3.000
5.08mm, Euro Header, Vertical, Open End	17	395310017	395310317	395310417	395310517	395310617	395310717	395310817	395310917	395311017	395311117	395311217	395311317	395311417	395311517	395311617	86.36	3.400	81.28	3.200
5.08mm, Euro Header, Vertical, Open End	18	395310018	395310318	395310418	395310518	395310618	395310718	395310818	395310918	395311018	395311118	395311218	395311318	395311418	395311518	395311618	91.44	3.600	86.36	3.400
5.08mm, Euro Header, Vertical, Open End	19	395310019	395310319	395310419	395310519	395310619	395310719	395310819	395310919	395311019	395311119	395311219	395311319	395311419	395311519	395311619	96.52	3.800	91.44	3.600
5.08mm, Euro Header, Vertical, Open End	20	395310020	395310320	395310420	395310520	395310620	395310720	395310820	395310920	395311020	395311120	395311220	395311320	395311420	395311520	395311620	101.60	4.000	96.52	3.800
5.08mm, Euro Header, Vertical, Open End	21	395310021	395310321	395310421	395310521	395310621	395310721	395310821	395310921	395311021	395311121	395311221	395311321	395311421	395311521	395311621	106.68	4.200	101.60	4.000
5.08mm, Euro Header, Vertical, Open End	22	395310022	395310322	395310422	395310522	395310622	395310722	395310822	395310922	395311022	395311122	395311222	395311322	395311422	395311522	395311622	111.76	4.400	106.68	4.200
5.08mm, Euro Header, Vertical, Open End	23	395310023	395310323	395310423	395310523	395310623	395310723	395310823	395310923	395311023	395311123	395311223	395311323	395311423	395311523	395311623	116.84	4.600	111.76	4.400
5.08mm, Euro Header, Vertical, Open End	24	395310024	395310324	395310424	395310524	395310624	395310724	395310824	395310924	395311024	395311124	395311224	395311324	395311424	395311524	395311624	121.92	4.800	116.84	4.600

TOLERANCES			
MM	TOL	INCH	TOL
0-6	±0.25	0-.24	±.010
>6-30	±0.40	.24-1.18	±.016
>30-120	±0.50	1.18-4.76	±.020
>120	±0.80	>4.76	±.031

REVISED DOC TOL
 EC NO: PG2017-0861
 DRAWN: CRADDOREWS 2017/03/23
 CHKD:
 APPR: BRUPERT 2017/04/18

QUALITY SYMBOLS
 ▽=0
 ▽=0

GENERAL TOLERANCES (UNLESS SPECIFIED)

	mm	INCH
4 PLACES	± ---	± ---
3 PLACES	± ---	± ---
2 PLACES	± ---	± ---
1 PLACE	± ---	± ---
ANGULAR ± ---°		

DRAFT WHERE APPLICABLE
 MUST REMAIN WITHIN DIMENSIONS

DIMENSION STYLE
 MM/IN

DRAWN BY DATE
 LROTHAUS 12/6/05

CHECKED BY DATE
 C. YORK 01/04/06

APPROVED BY DATE

SCALE
 INCH

DESIGN UNITS
 INCH

THIRD ANGLE PROJECTION

TITLE
 5.08MM, EURO HEADER, VERTICAL, OPEN END

MATERIAL NO.
 SEE CHART

DOCUMENT NO.
 SD-39531-003

SHEET NO.
 2 OF 2

moLEX MOLEX INCORPORATED

THIS DRAWING CONTAINS INFORMATION THAT IS PROPRIETARY TO MOLEX INCORPORATED AND SHOULD NOT BE USED WITHOUT WRITTEN PERMISSION