

## SPECIFICATION

Part No. : **TG.09.0113W**

Product Name : 4G/3G/2G Cellular Hinged SMA (M) Mount Monopole

Feature : 700MHz to 3800MHz  
LTE\*/GSM/CDMA/HSPA/UMTS  
700\*/850/900/1700/1800/1900/2100/2300/3500/3700  
Rotatable hinge design for optimal reception  
\*LTE 700MHz Band Compatible only when connected  
directly on ground plane lengths of 60mm or more  
RoHS Compliant



## 1. Introduction

The TG.09 Penta-band Cellular Hinged Rotatable SMA antenna is a high efficiency monopole antenna. Compared to other much larger antennas on the market, it has superior wide-band high efficiency characteristics. This antenna is used by many of the leading wireless device providers in the world marketplace.

The unique rotatable hinge design enables the user to rotate the antenna to the best angle for an optimal cellular signal reception. As the upper antenna element can move in any direction, it also reduces damage from impact force from any angle to the antenna, compared to traditional hinged right angle or fixed right angle designs or straight antennas.

The tiny dimensions of this antenna coupled with excellent RF performance and an aesthetic high end design feel make it the ideal cellular antenna for routers, vehicle tracking devices, telematics devices, remote monitoring systems, and POS devices.

The TG.09, as all monopole antennas works best connected directly to the ground-plane of the device main-board. Taoglas offers support services to characterize antenna efficiency on your individual device ground-plane.

The TG.09 antenna also supports LTE 700MHz band applications when it is directly connected to ground-planes with lengths above 60mm.

Please contact Taoglas regional support center first if you wish to do PTCRB or network approvals with this antenna attached to your device, so we can check RF integration is correct and do a pre-test first to ensure optimized passive and active performance and a smooth and quick certification approval process.

This antenna also comes in a black housing version. TG.09.0113

## 2. Specification

ELECTRICAL										
Communication System	4G/3G/2G Cellular									
	700 LTE	AMPS	GSM	DCS	PCS	UMTS	2300 LTE	2700 LTE	3500 LTE	3700 LTE
Frequency (MHz)	703 ~ 803	824 ~ 896	880 ~ 960	1710 ~ 1880	1850 ~ 1990	1710 ~ 2170	2300 ~ 2400	2490 ~ 2690	3400 ~ 3600	3600 ~ 3800
Efficiency (free space)*	18%	22%	22%	25%	30%	30%	17%	32%	28%	43%
Gain (dBi, free space)*	-3.0	-2.6	-3.0	0.9	0.9	0.9	-1.3	1.1	1.8	3.1
Efficiency (mounted on PCB)*	52%	58%	57%	61%	58%	54%	31%	59%	36%	37%
Gain (dBi, mounted on PCB)*	0.8	1.7	1.8	3.4	3.4	3.4	2.3	3.7	4.3	2.6
Impedance	50Ω									
Polarization	Linear									
Radiation Pattern	Omnidirectional									
Input Power	10W									
MECHANICAL										
Antenna Length	72 ± 1.5 mm									
Antenna Diameter	10 ± 0.3 mm									
Casing	POM									
Connector	SMA Male (Brass)									
Weight	8g									
ENVIRONMENTAL										
Temperature Range	-40°C to 85°C									
Storage Temperature	-40°C ~ +85°C									
Humidity	Non-condensing 65°C 95% RH									

\* Average efficiency and peak gain of antenna sitting 180° in Free Space and on 150\*90mm ground plane at the side of the PCB. Please refer to section 3 for testing detail.

### 3. Antenna Characteristics

#### 3.1 Test Setup

The TG.09 was measured and tested in four different environments

- a. Free space
- b. On the edge of a 150\*90mm ground plane - common size for IoT devices. TG.09 is mounted on the 90mm edge for testing.
- c. In the center of a 300\*300mm ground plane – simulate the effect of mounting in the center of a big ground plane.
- d. On the edge of a 300\*300mm ground plane - simulates the effect of mounting TG.09 on top of a large gateway/router.

Straight Position

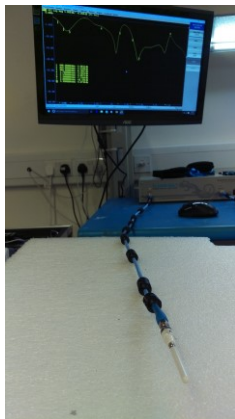

Free Space

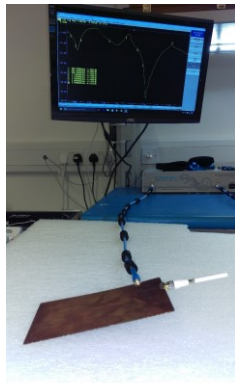

150mm x 90mm  
Ground Plane



300mm x 300mm  
Ground Plane Edge

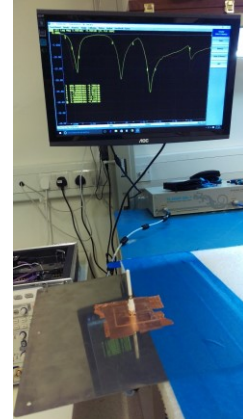

300mm x 300mm  
Ground Pane Center

Antenna in 90° Bend Position

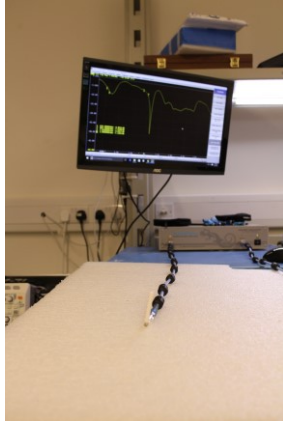

Free Space



150mm x 90mm  
Ground Plane

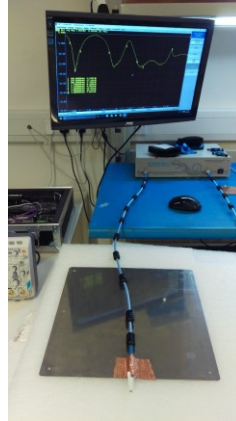

300mm x 300mm  
Ground Plane Edge

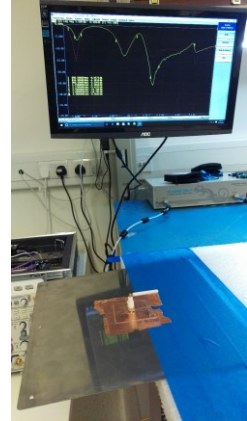

300mm x 300mm  
Ground Plane Center

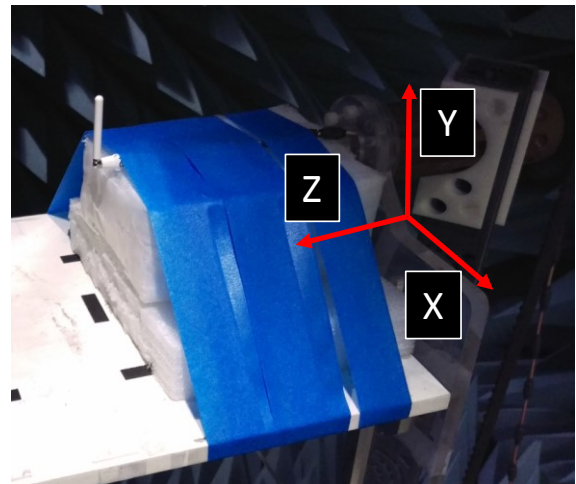
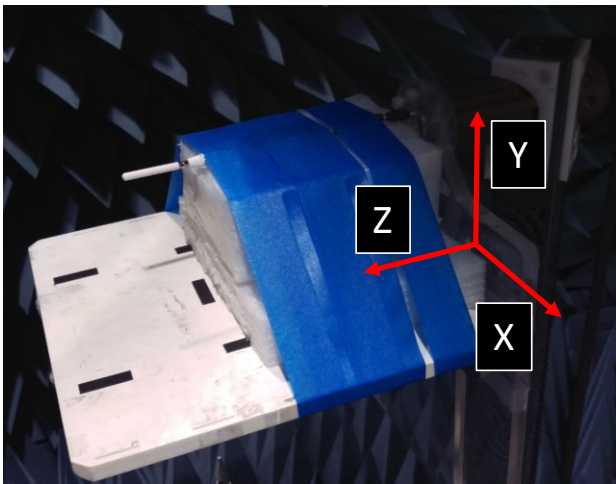

Chamber Setup

### 3.2 Return Loss

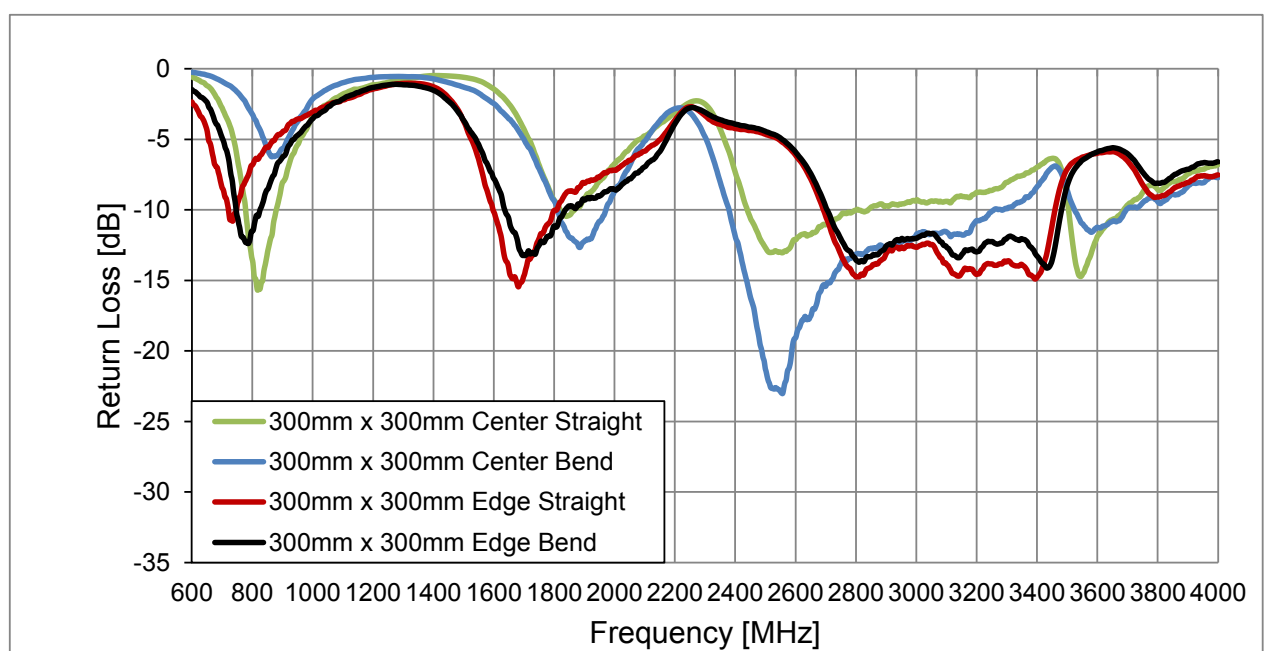
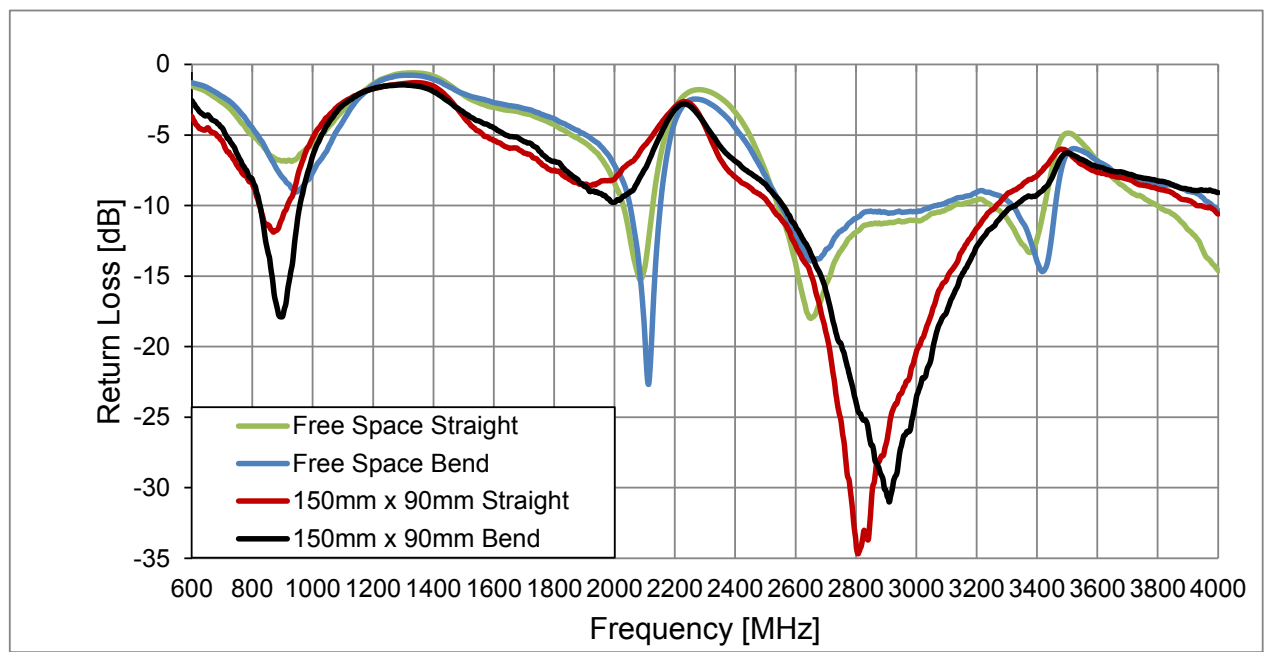

### 3.3 VSWR

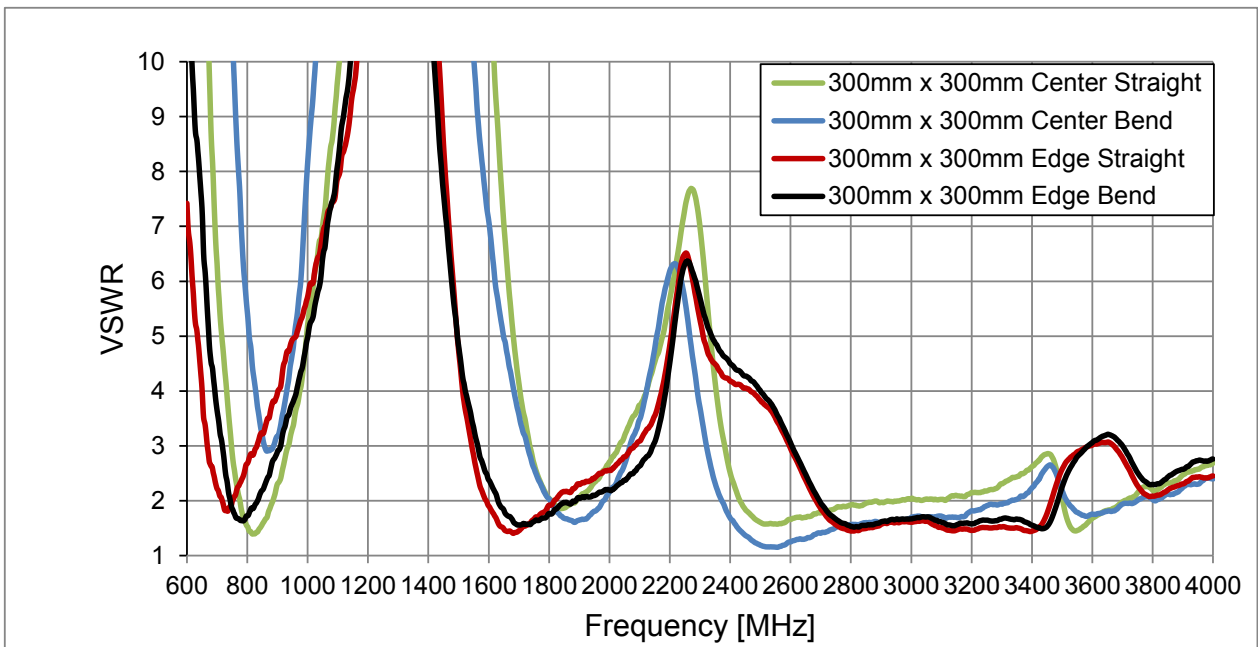
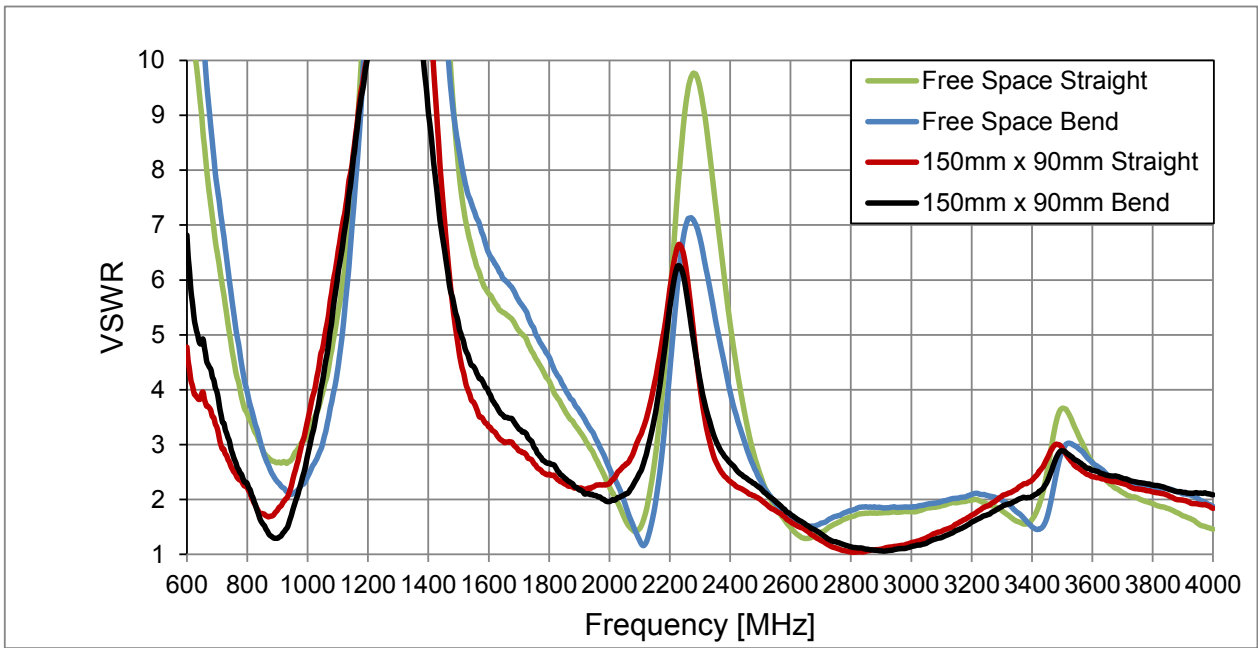

### 3.4 Efficiency

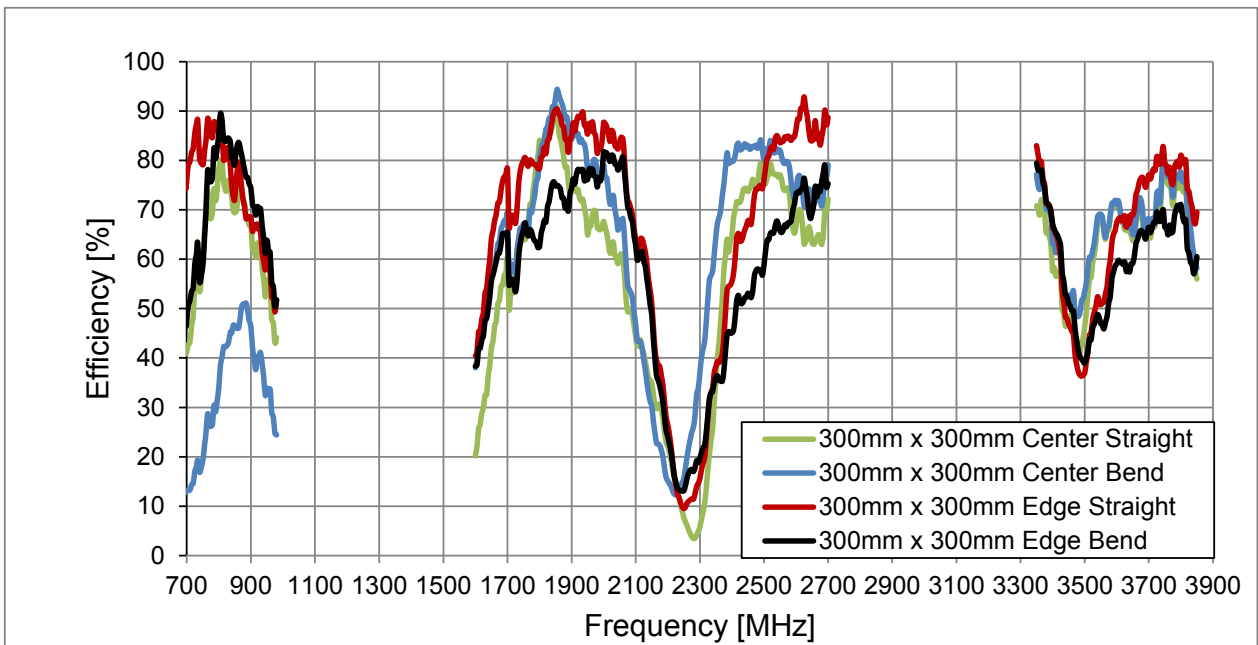
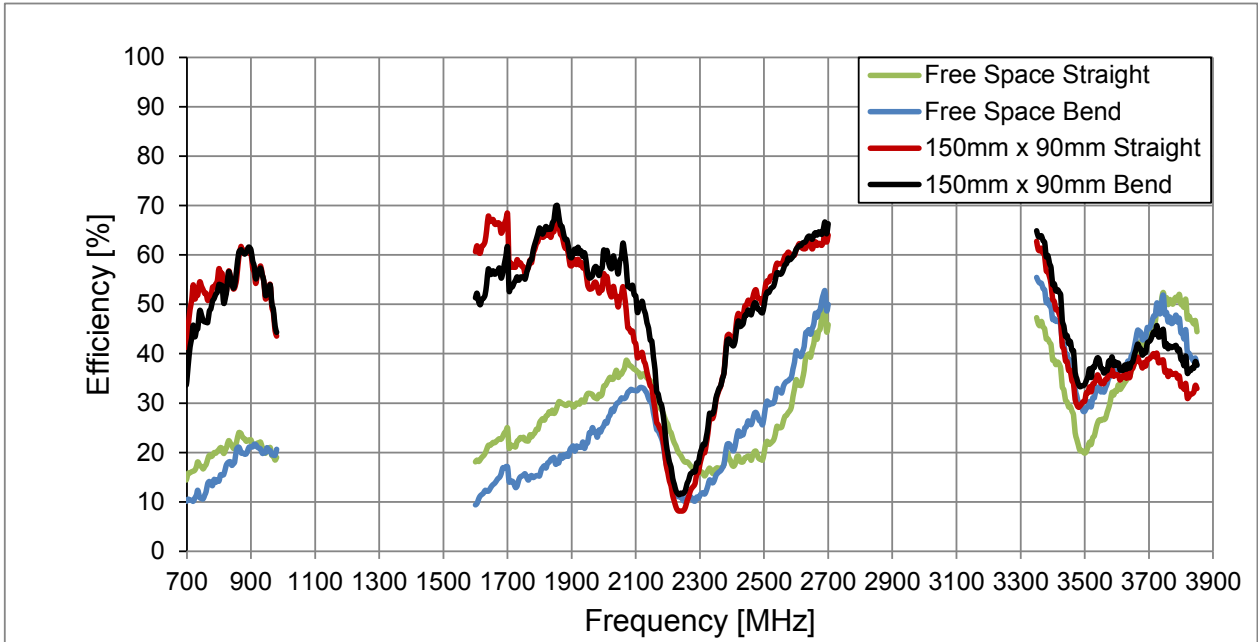



### 3.5 Peak Gain

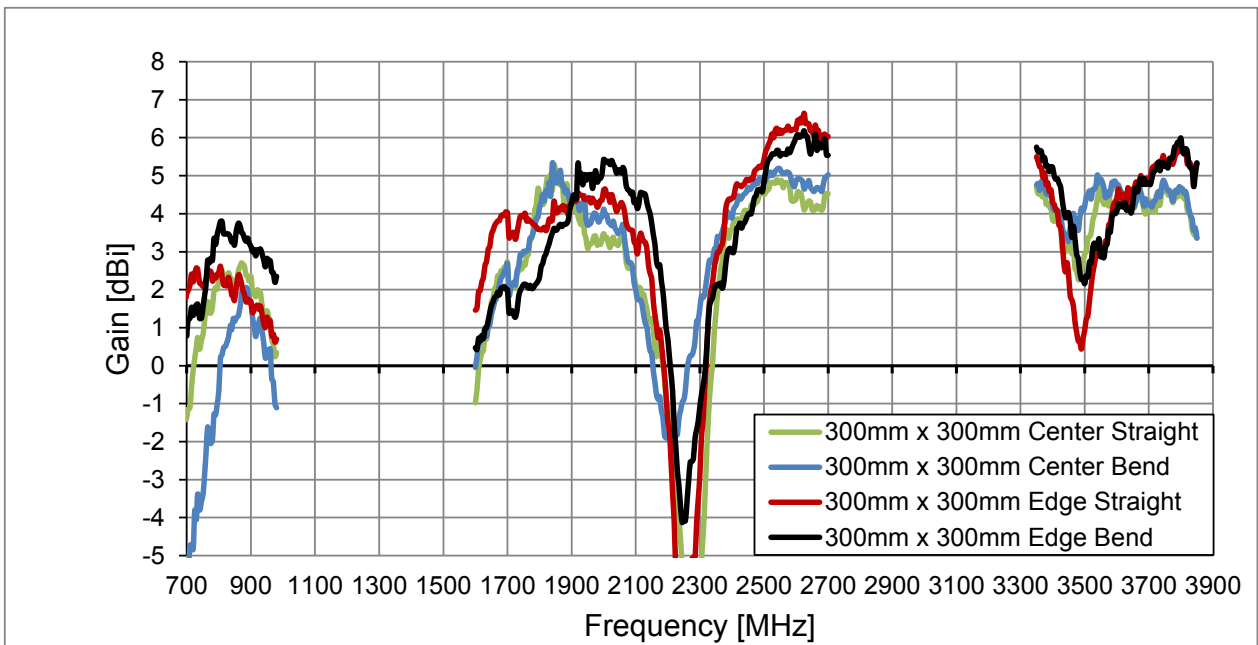
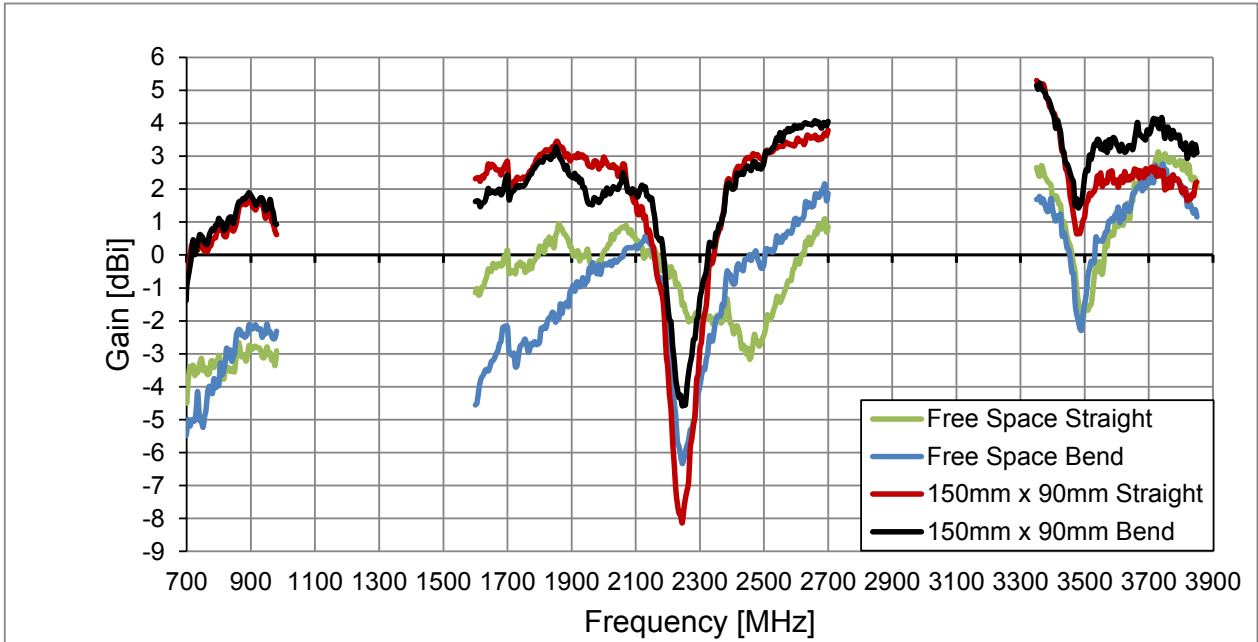

### 3.6 Average Gain

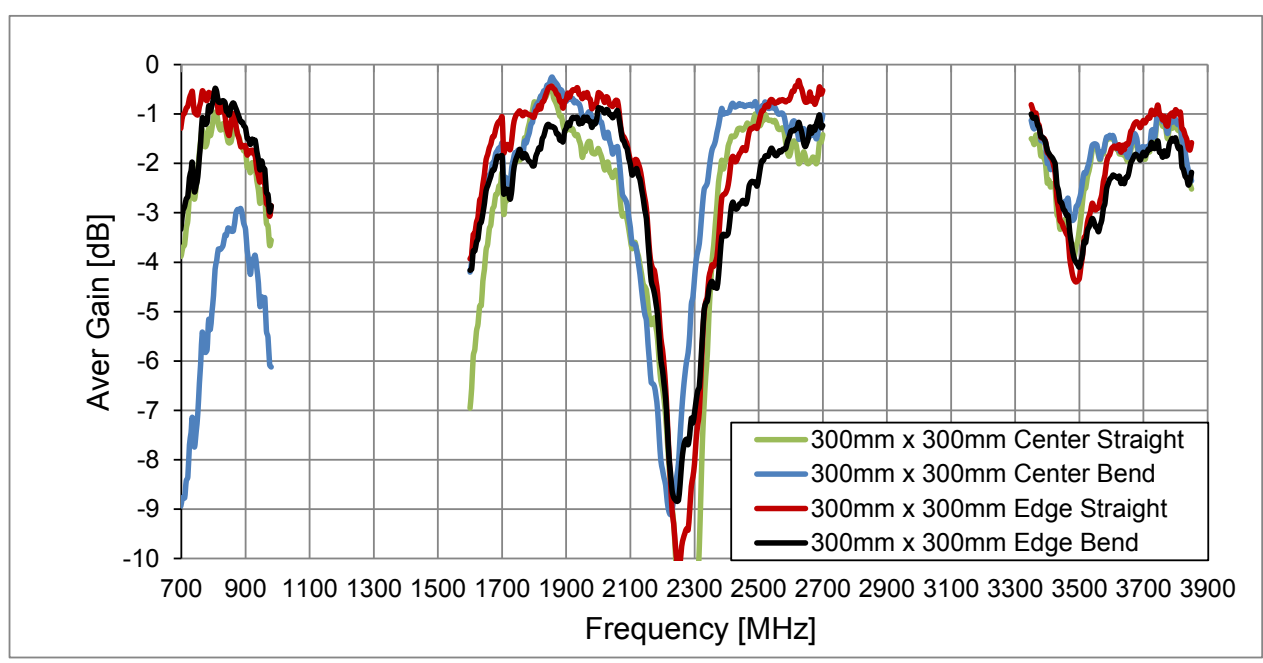
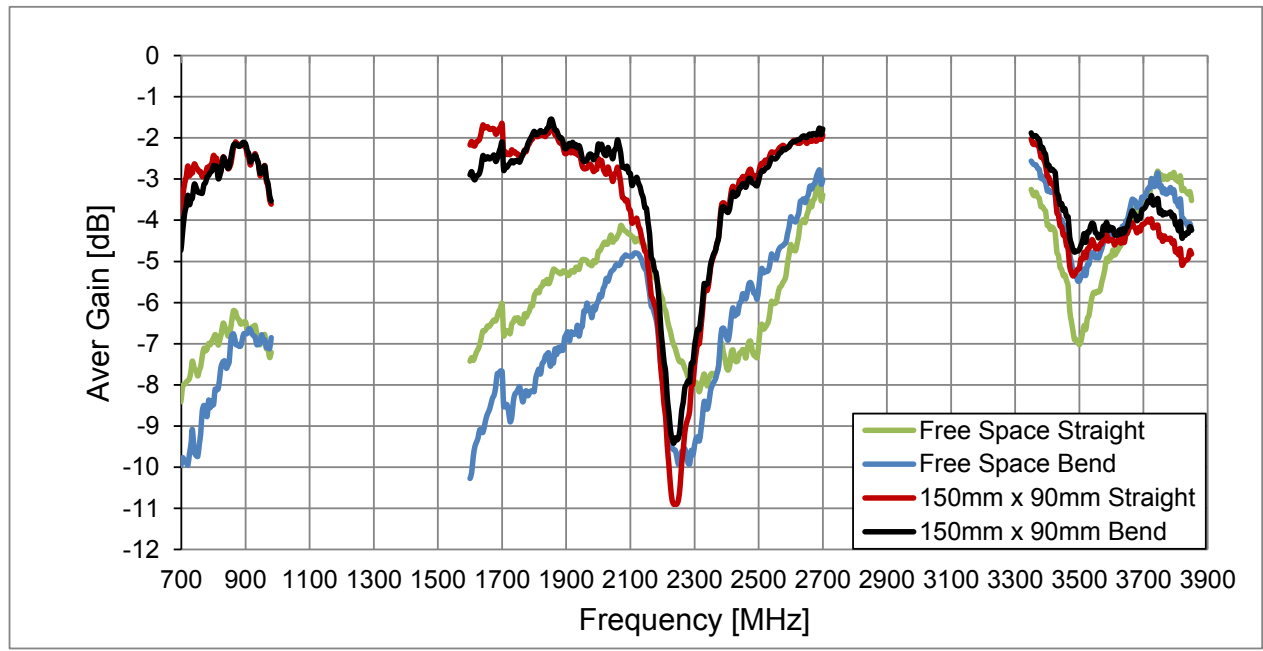

# 4. Radiation Patterns

## 4.1 TG.09 in Free Space – Straight

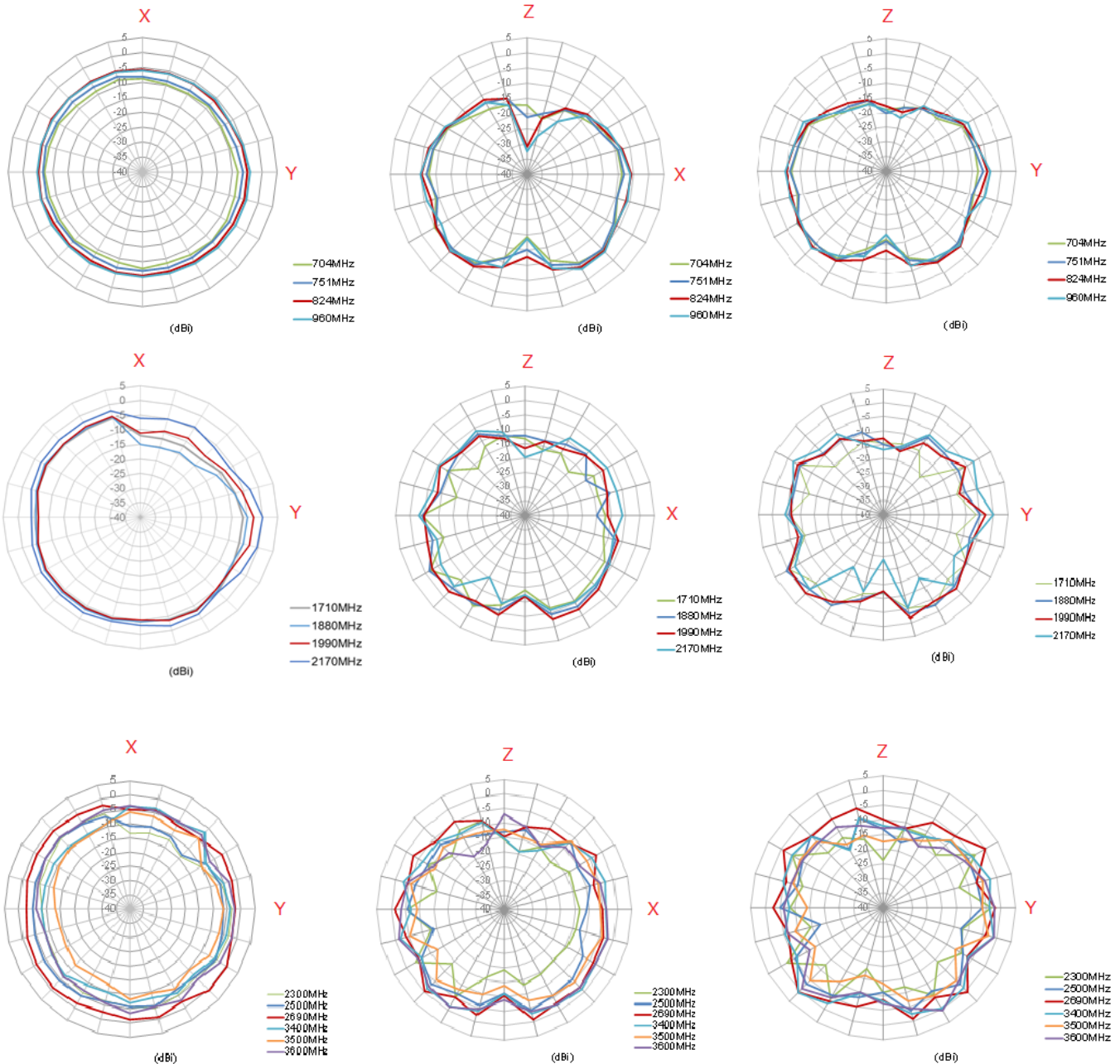

## 4.2 TG.09 in Free Space – 90°

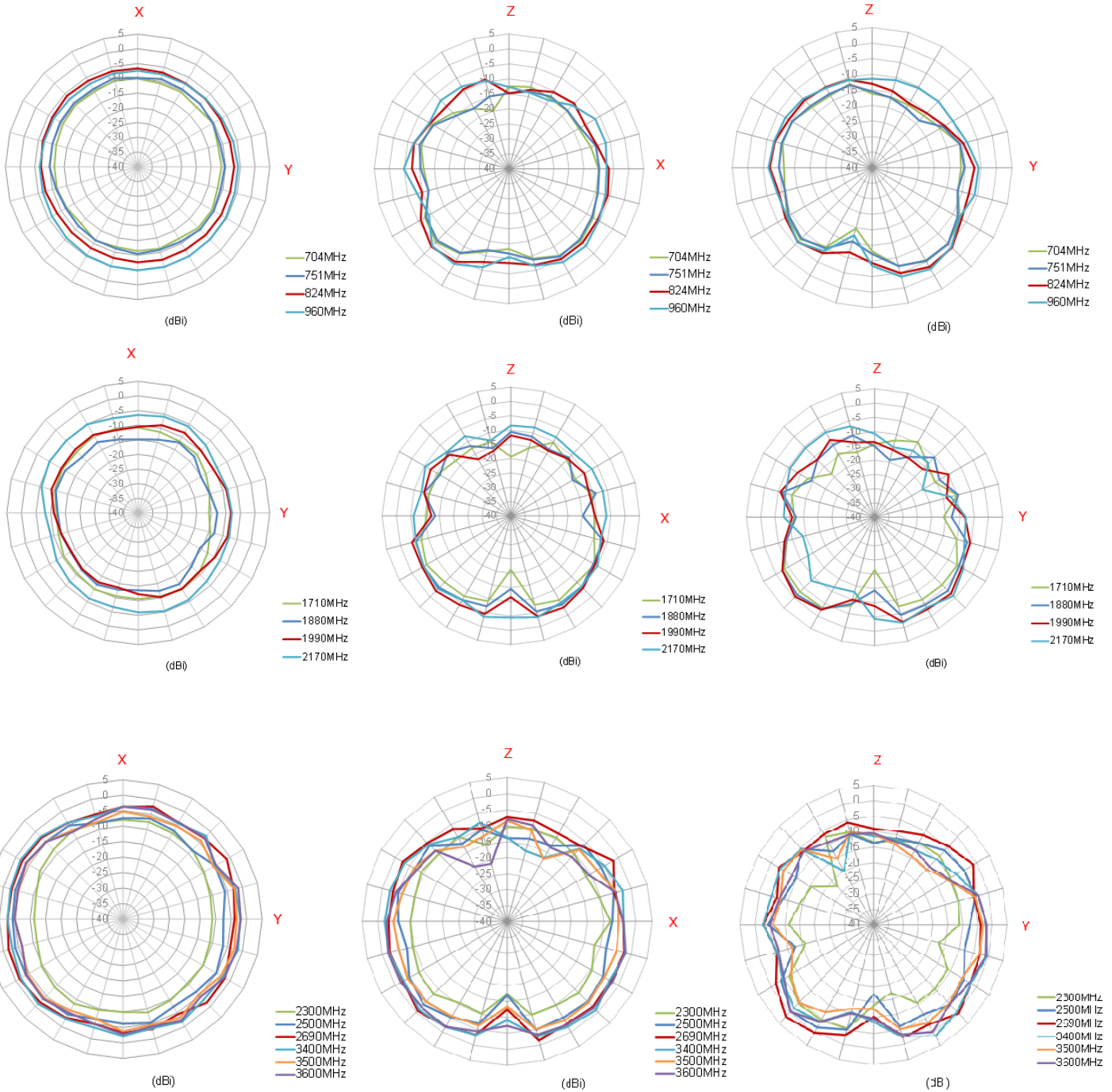

### 4.3 TG.09 on 150\*90mm Ground Plane – Straight

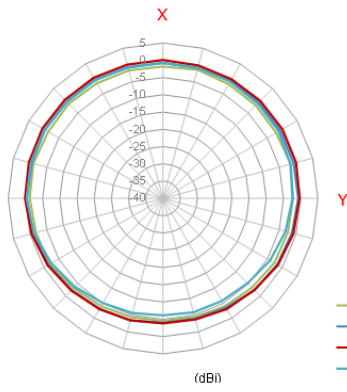

— 704MHz  
— 751MHz  
— 824MHz  
— 960MHz

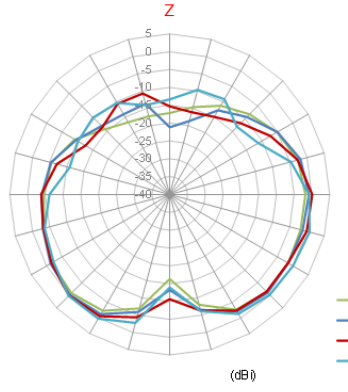

— 704MHz  
— 751MHz  
— 824MHz  
— 960MHz

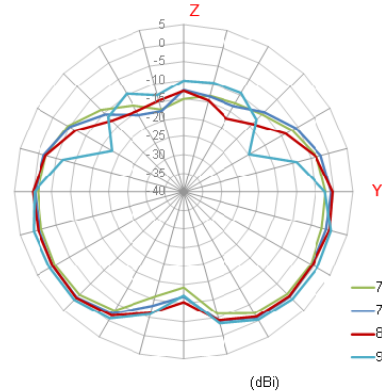

— 704MHz  
— 751MHz  
— 824MHz  
— 960MHz

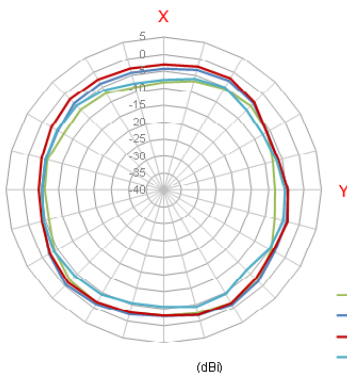

— 1710MHz  
— 1880MHz  
— 1990MHz  
— 2170MHz

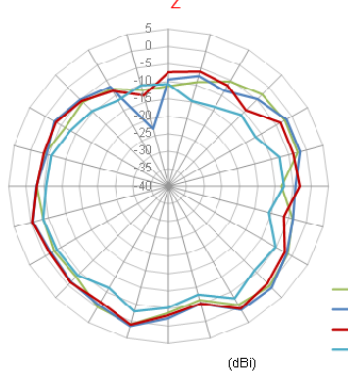

— 1710MHz  
— 1880MHz  
— 1990MHz  
— 2170MHz

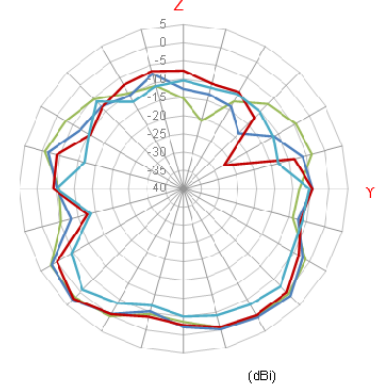

— 1710MHz  
— 1880MHz  
— 1990MHz  
— 2170MHz

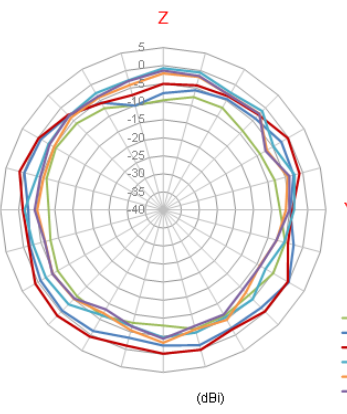

— 2300MHz  
— 2500MHz  
— 2690MHz  
— 3400MHz  
— 3500MHz  
— 3600MHz

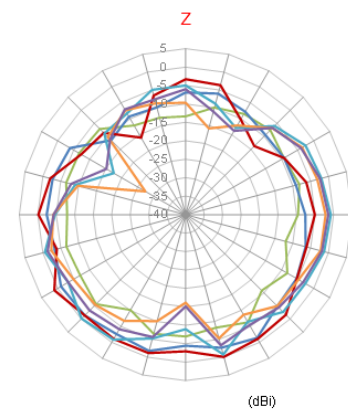

— 2300MHz  
— 2500MHz  
— 2690MHz  
— 3400MHz  
— 3500MHz  
— 3600MHz

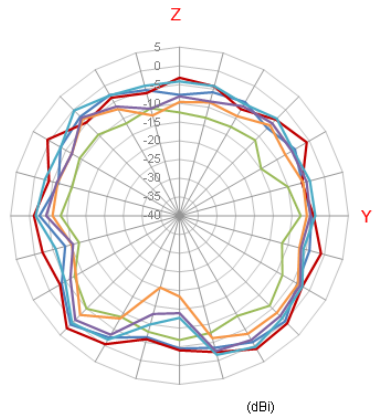

— 2300MHz  
— 2500MHz  
— 2690MHz  
— 3400MHz  
— 3500MHz  
— 3600MHz

### 4.4 TG.09 on 150\*90mm Ground Plane – 90°

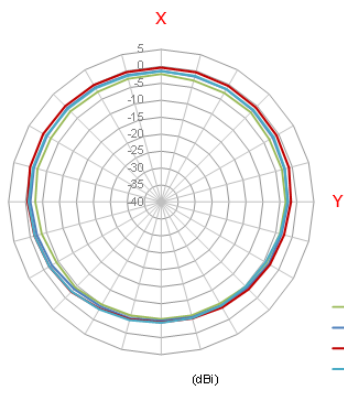

- 704MHz
- 751MHz
- 824MHz
- 960MHz

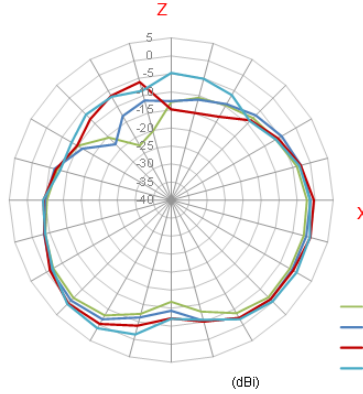

- 704MHz
- 751MHz
- 824MHz
- 960MHz

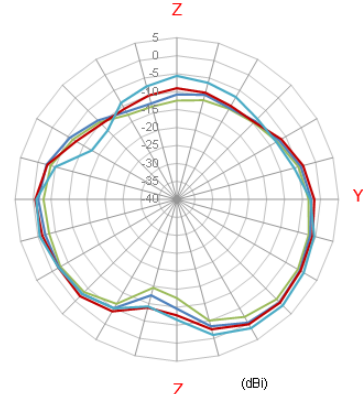

- 704MHz
- 751MHz
- 824MHz
- 960MHz

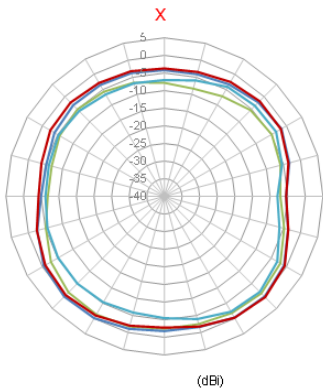

- 1710MHz
- 1880MHz
- 1990MHz
- 2170MHz

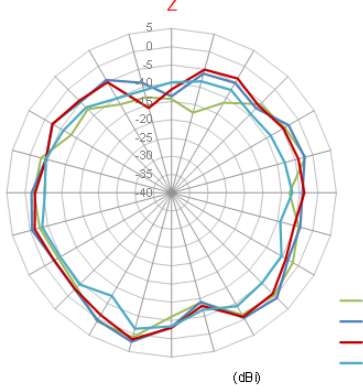

- 1710MHz
- 1880MHz
- 1990MHz
- 2170MHz

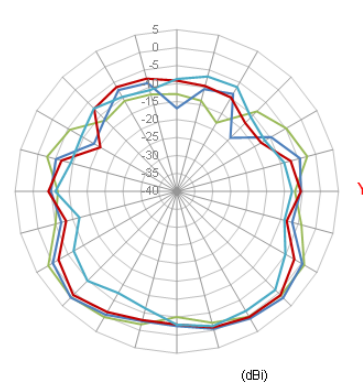

- 1710MHz
- 1880MHz
- 1990MHz
- 2170MHz

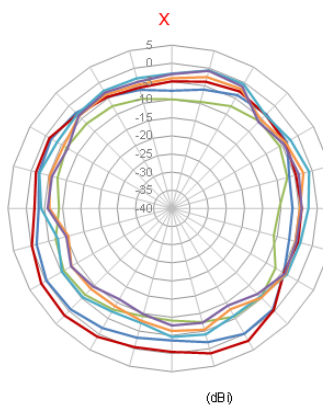

- 2300MHz
- 2500MHz
- 2690MHz
- 3400MHz
- 3500MHz
- 3600MHz

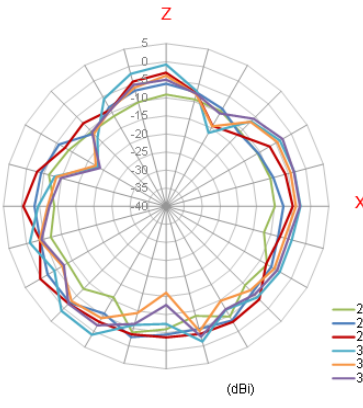

- 2300MHz
- 2500MHz
- 2690MHz
- 3400MHz
- 3500MHz
- 3600MHz

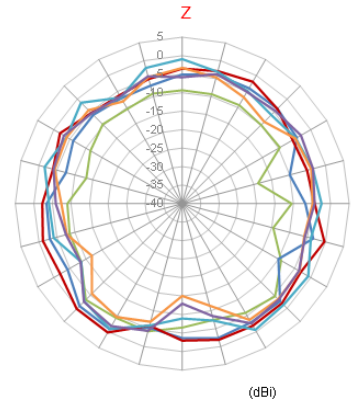

- 2300MHz
- 2500MHz
- 2690MHz
- 3400MHz
- 3500MHz
- 3600MHz

### 4.5 TG.09 on 300\*300mm Ground Plane Centre – Straight

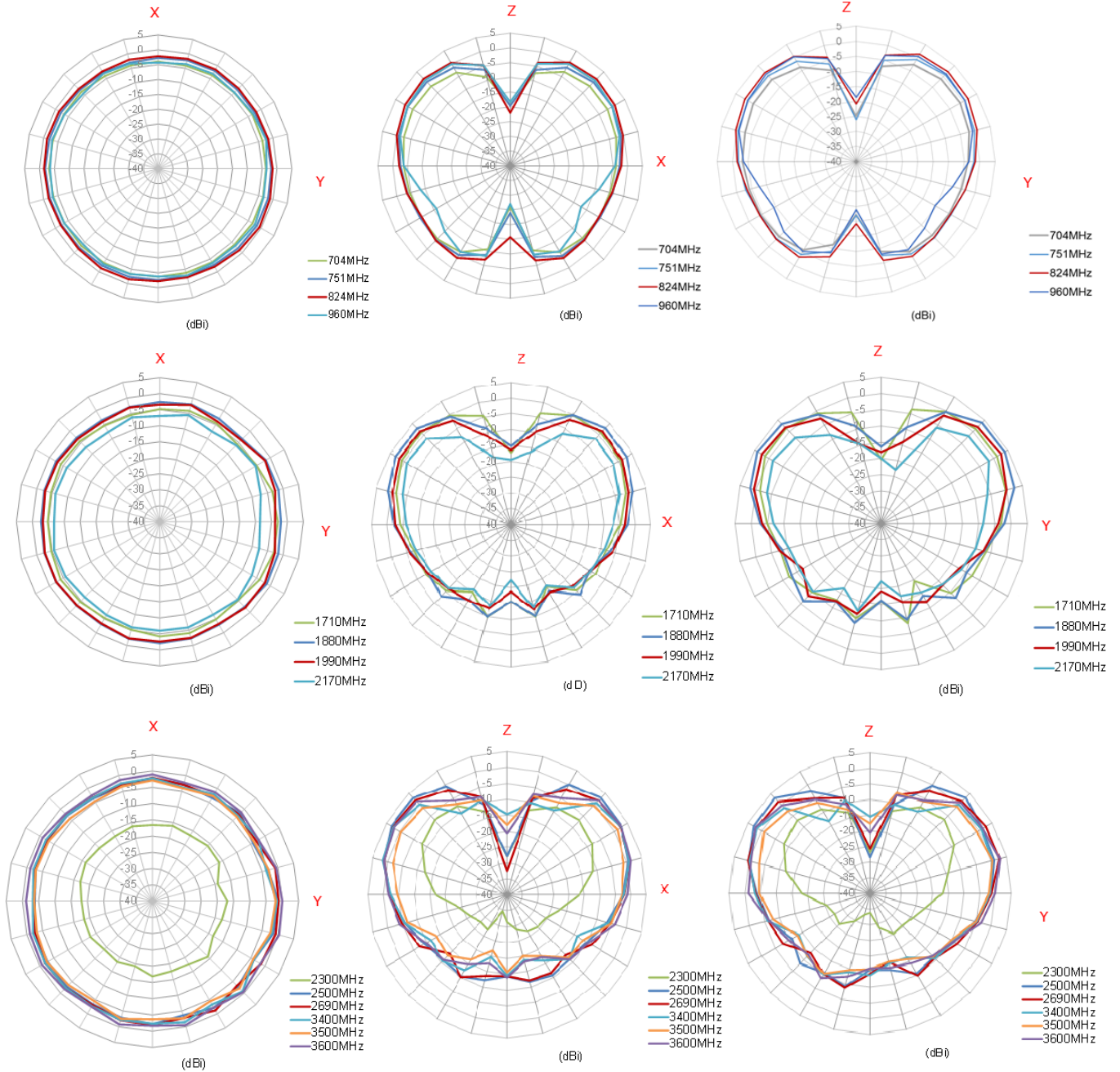

### 4.6 TG.09 on 300\*300mm Ground Plane Centre – 90°

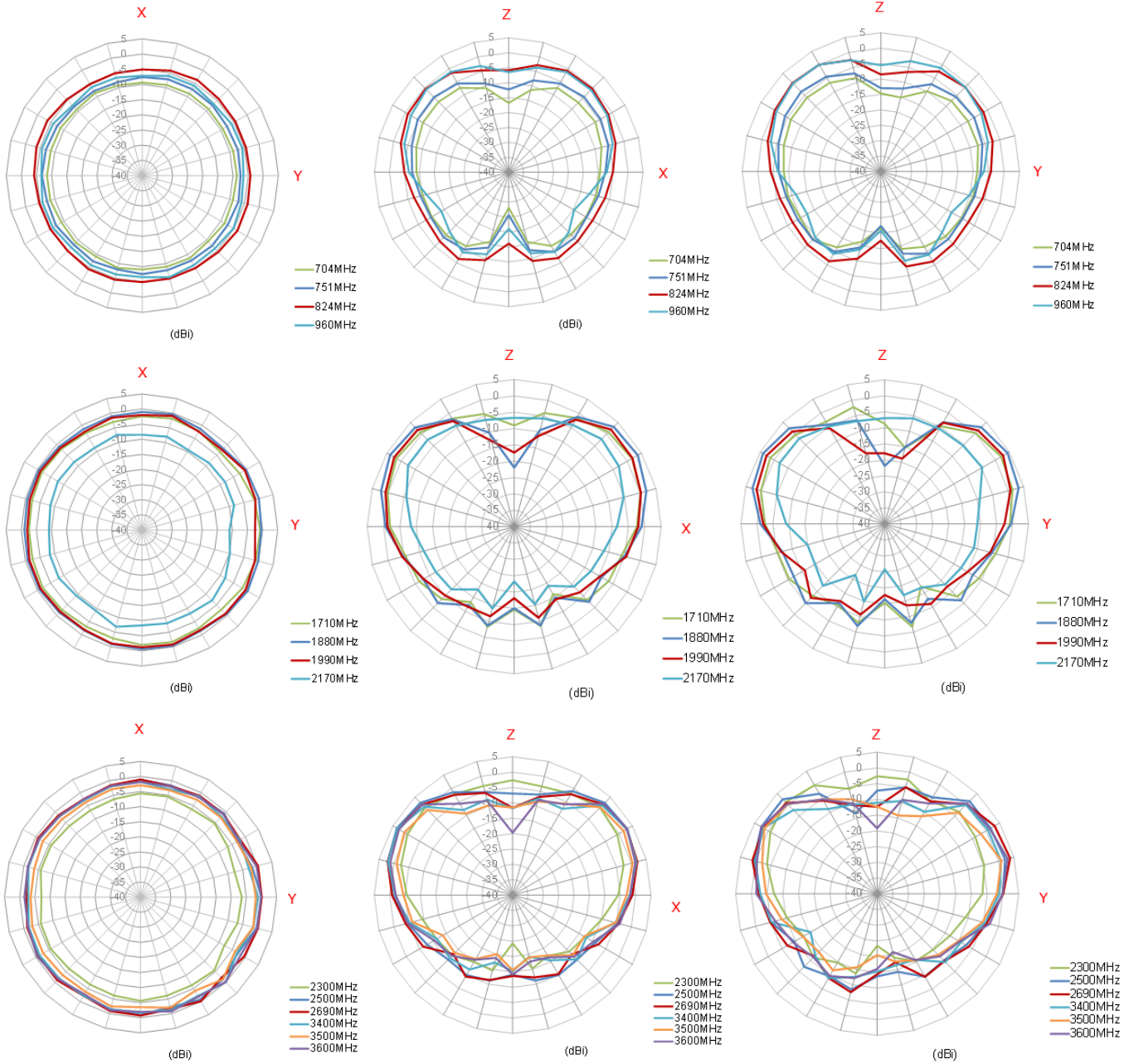



### 4.7 TG.09 on 300\*300mm Ground Plane Edge – Straight

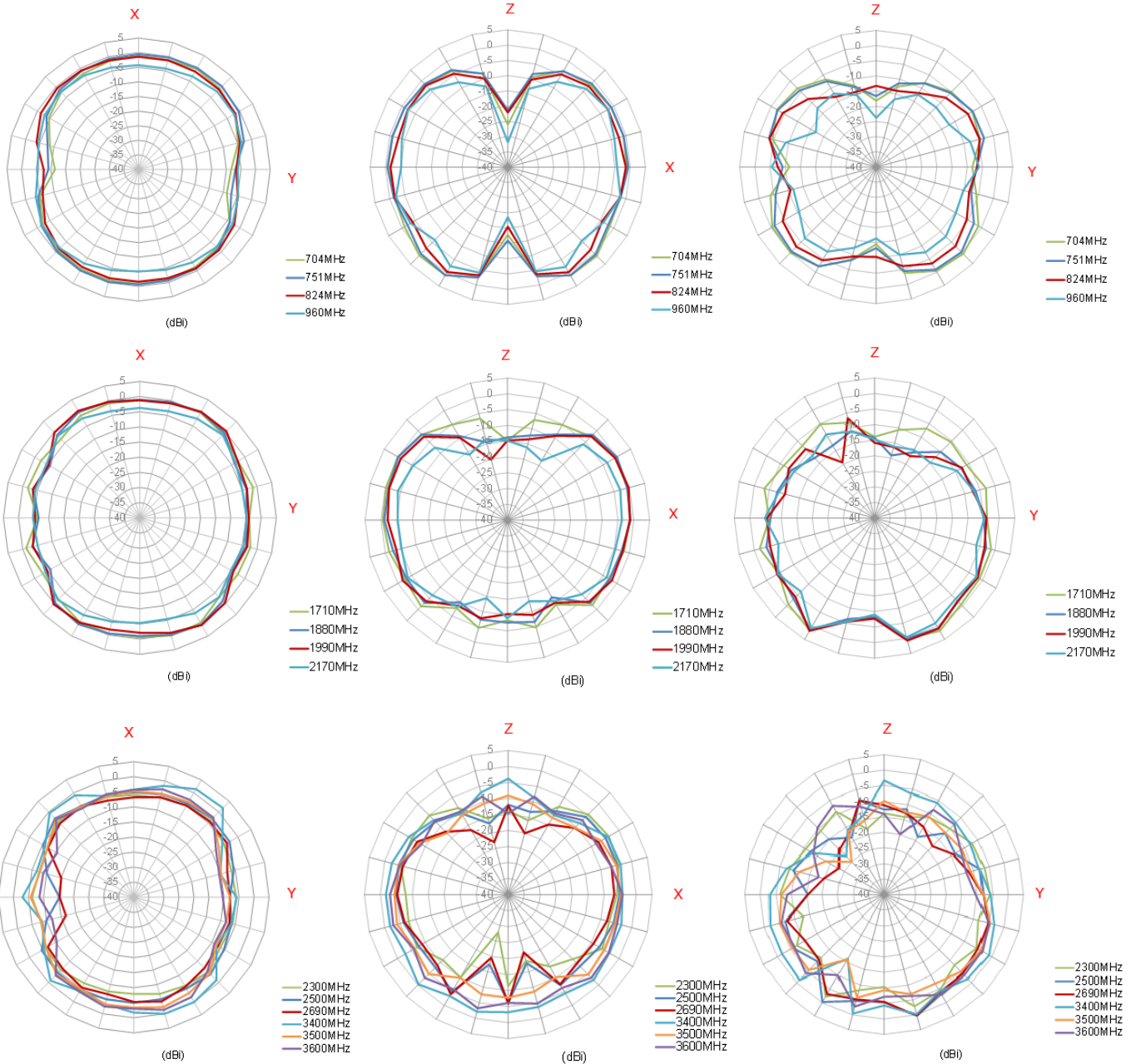

### 4.8 TG.09 on 300\*300mm Ground Plane Edge – 90°

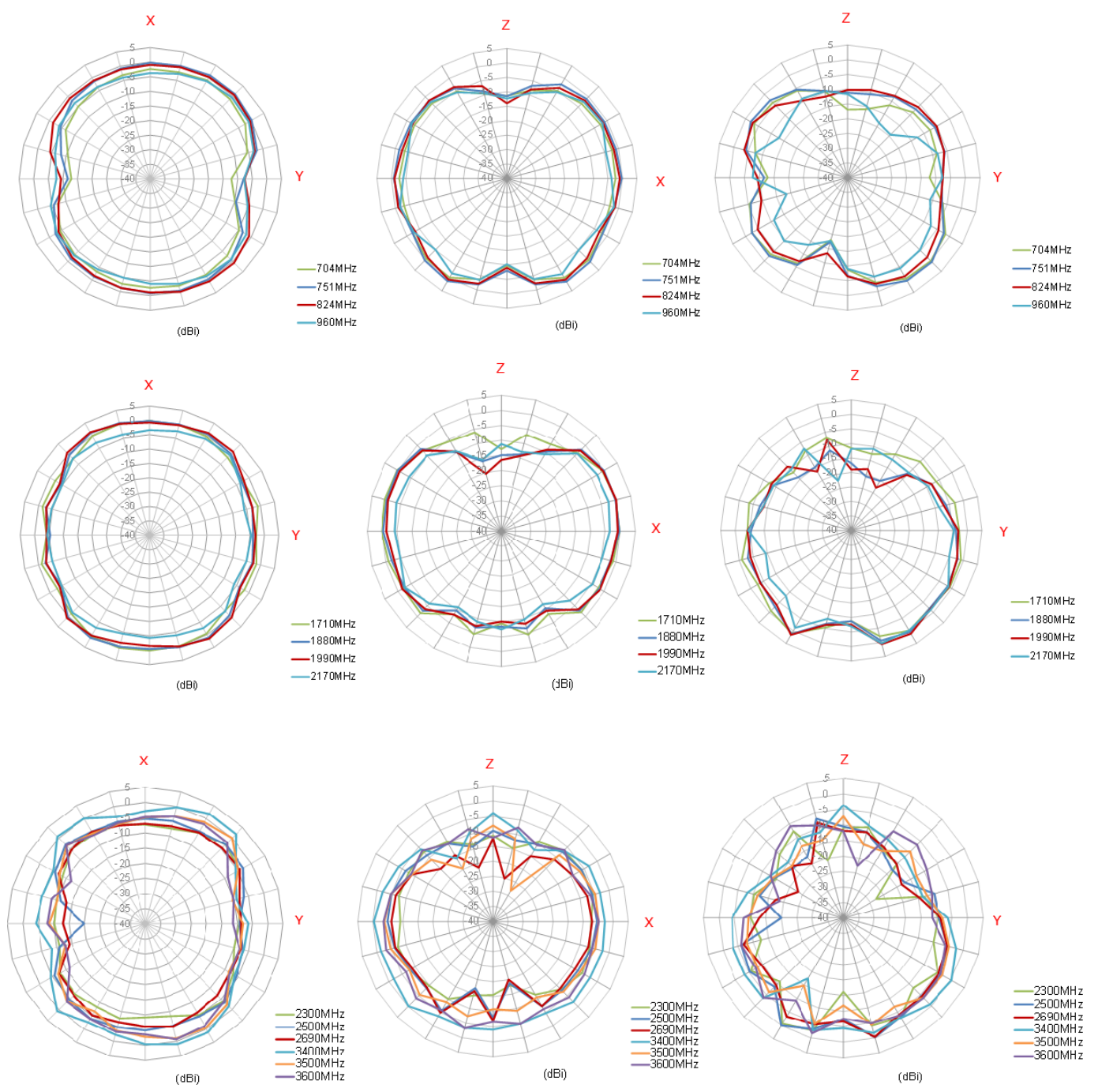

# 5. 3D Radiated Pattern

## 5.1 Free Space – Straight

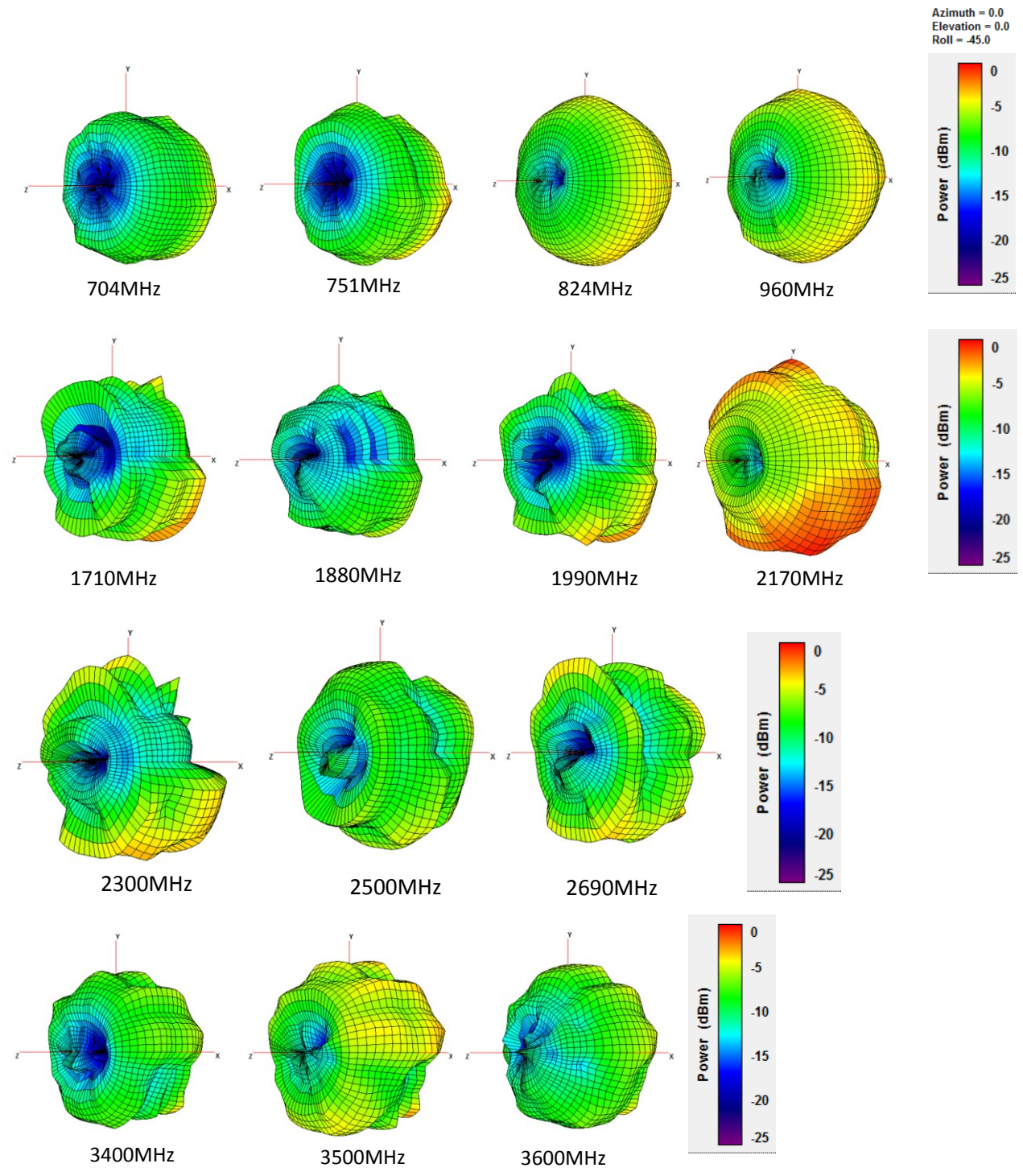

## 5.2 Free Space – 90°

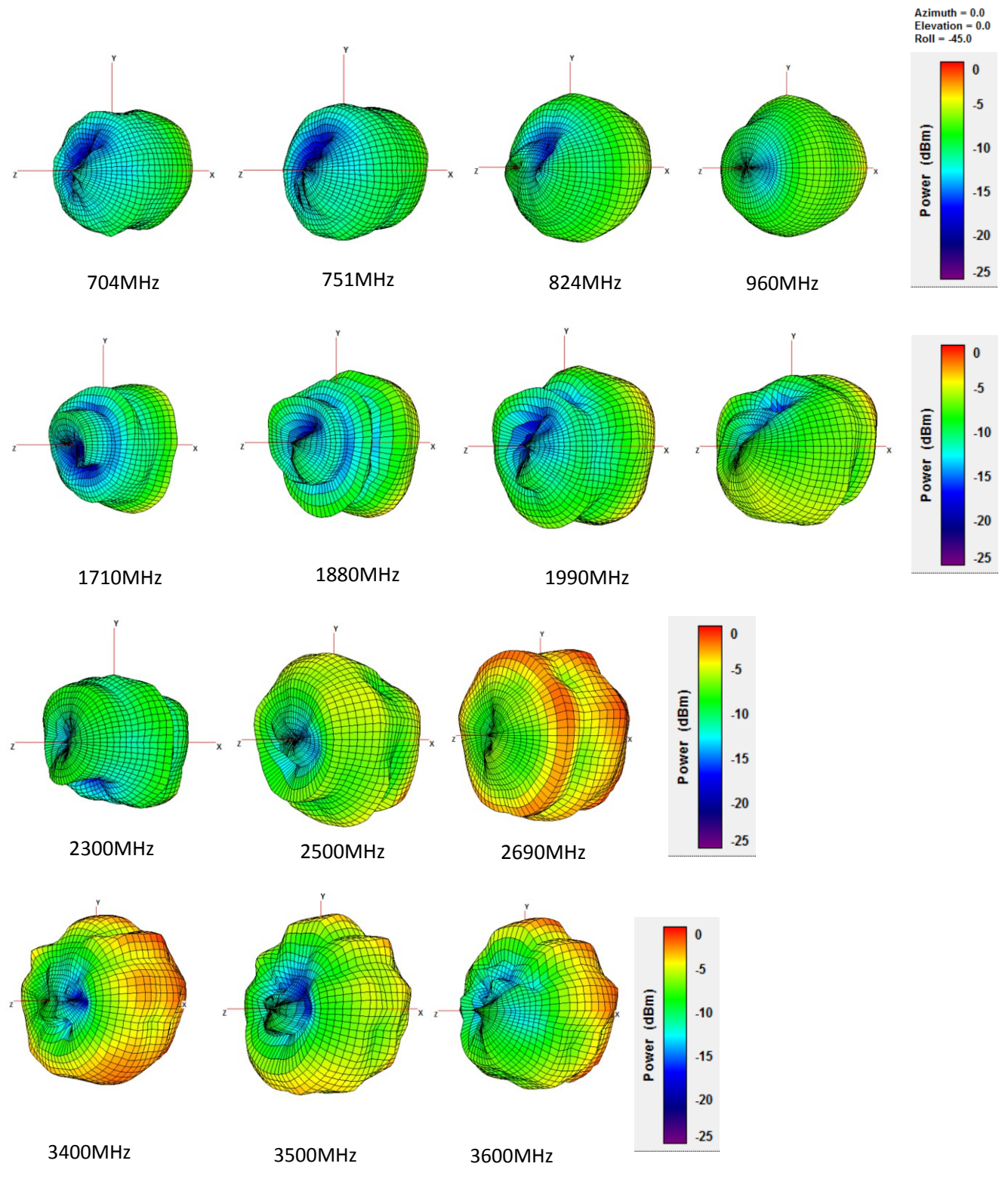

### 5.3 150\*90mm Ground Plane – Straight

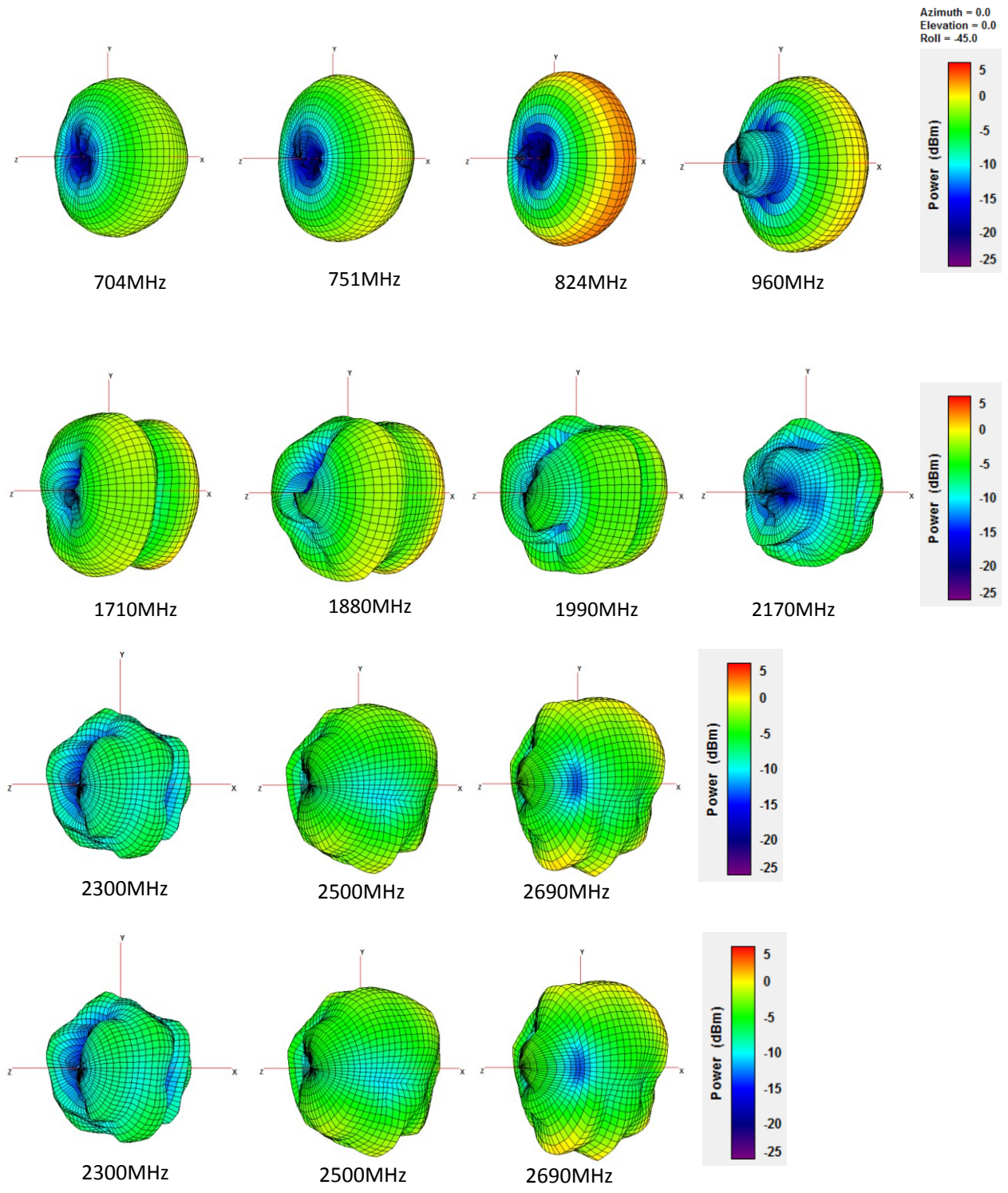

### 5.4 150\*90mm Ground Plane – 90°

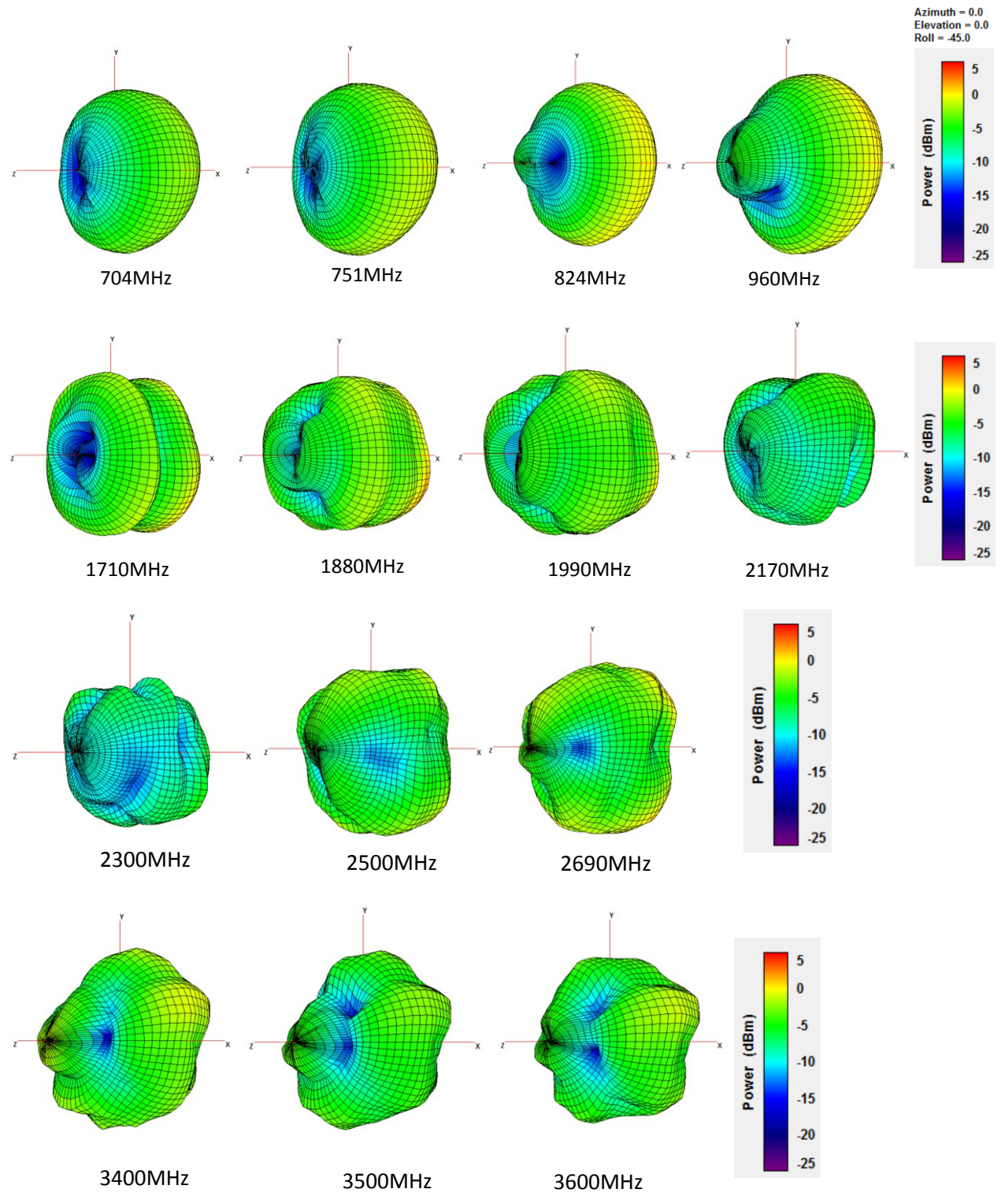

## 5.5 300\*300mm Ground Plane Center – Straight

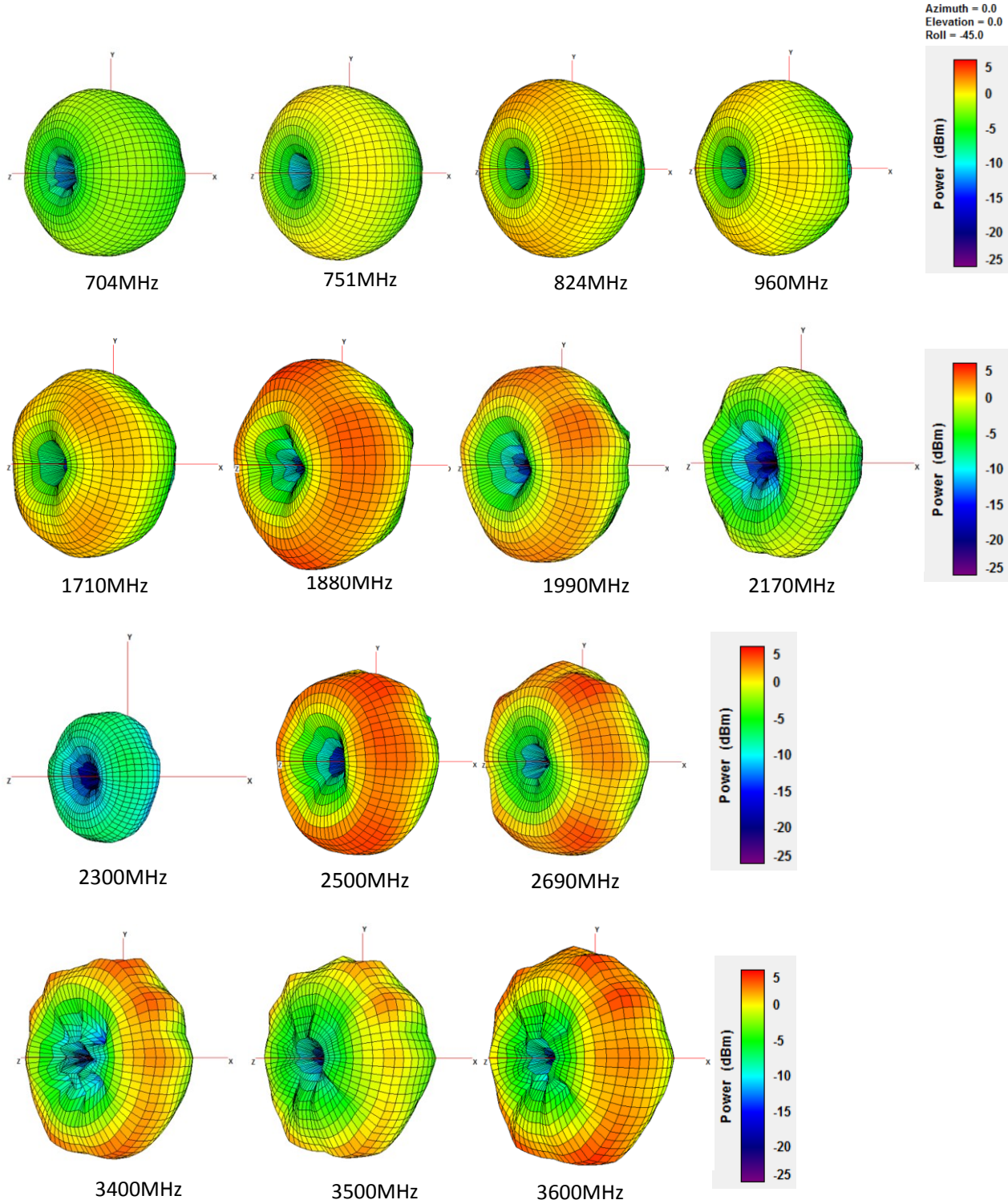

## 5.6 300\*300mm Ground Plane Center – 90°

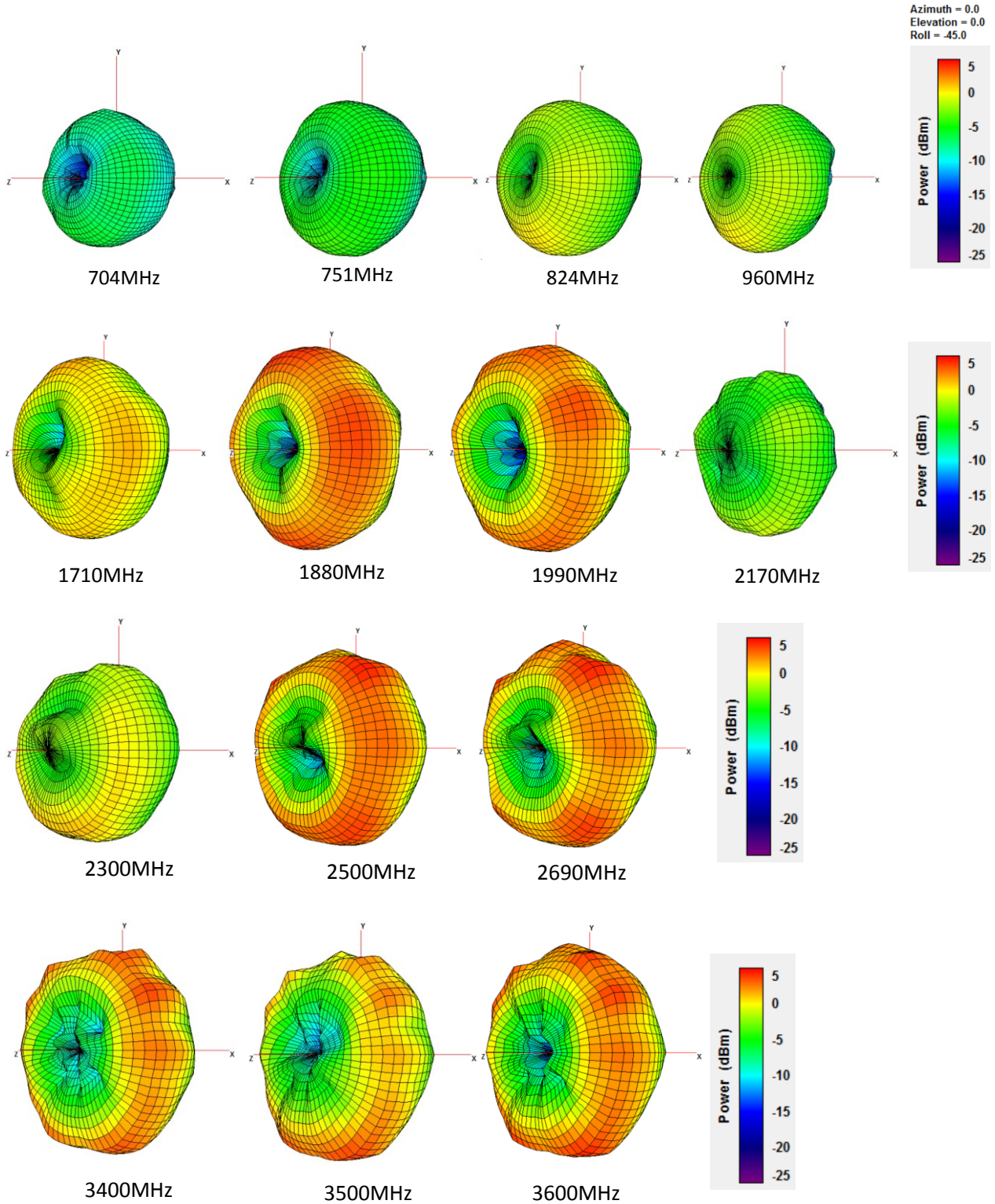



## 5.7 300\*300mm Ground Plane Edge – Straight

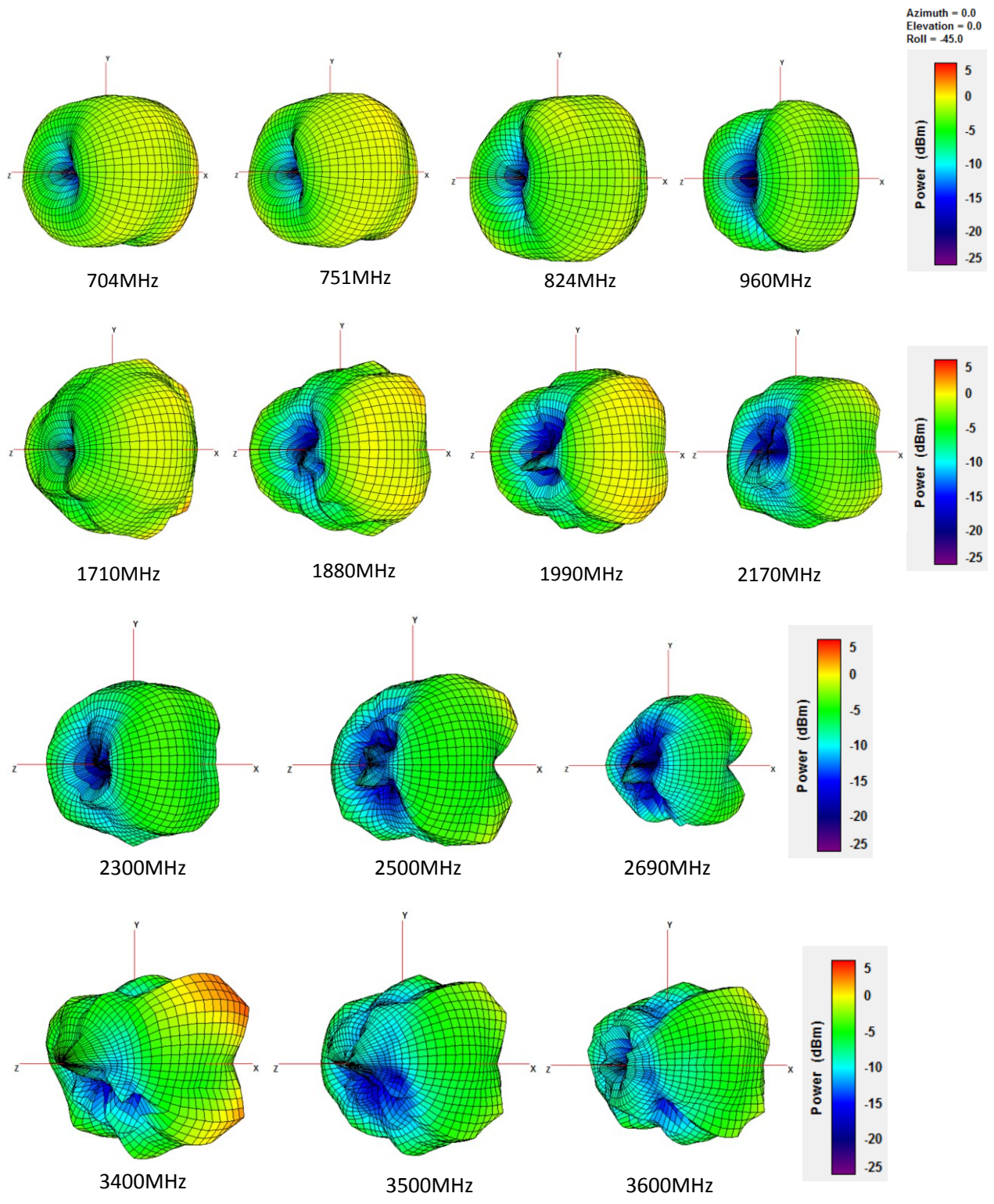

### 5.8 300\*300mm Ground Plane Edge – 90°

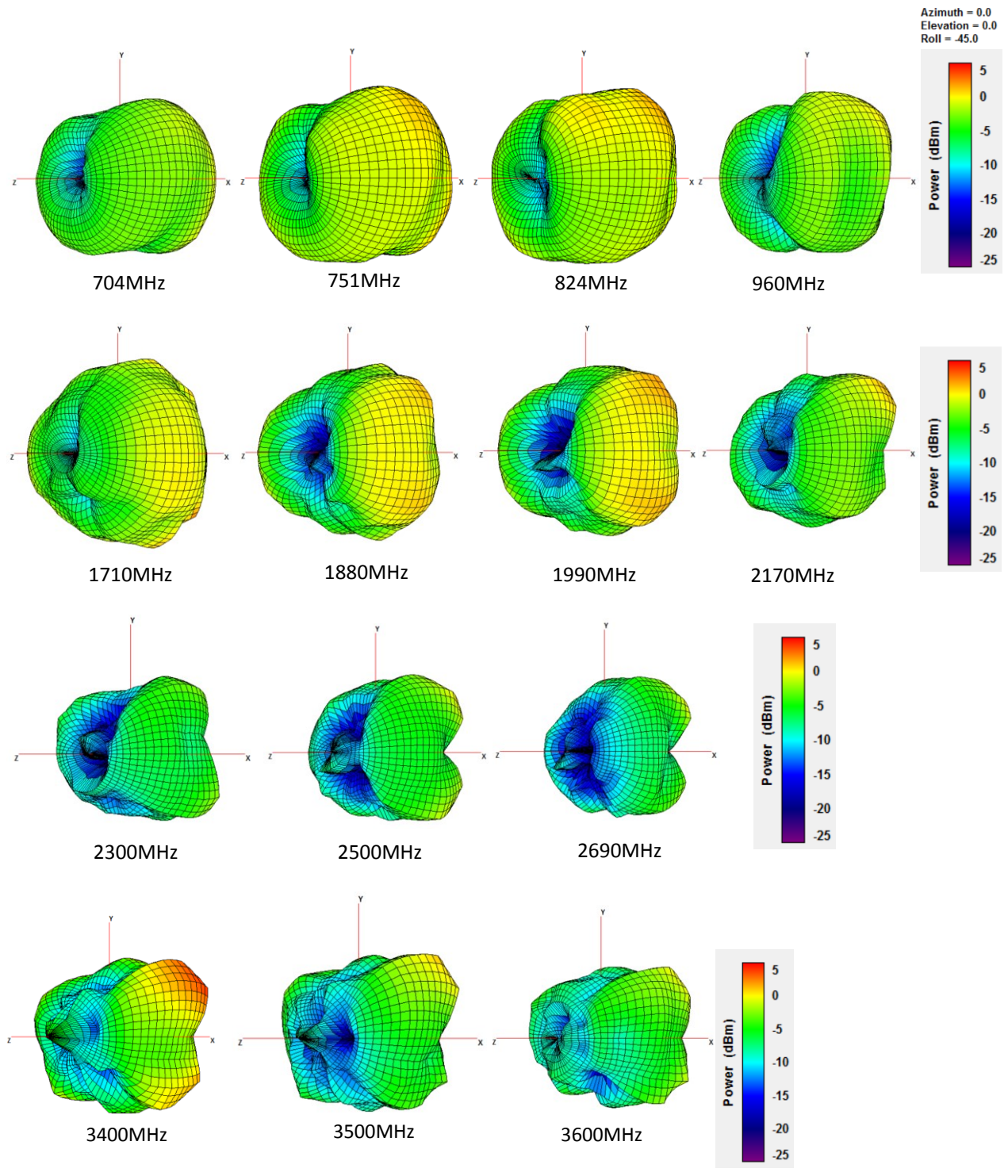

## 6. Mechanical Drawing (Unit: mm)

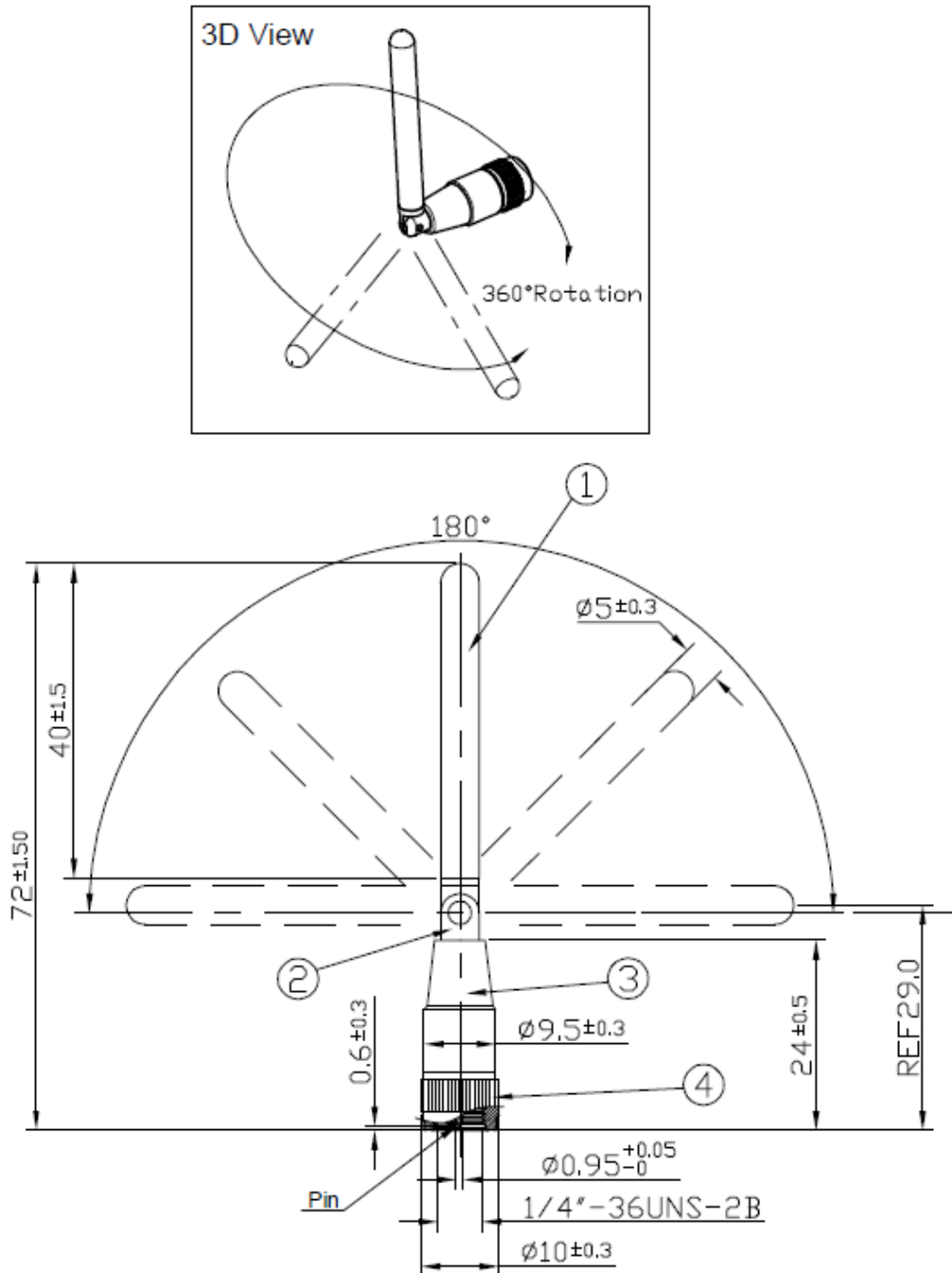

1	Housing	POM Black
2	Hinge	Brass Ni Plated
3	Cap	POM Black
4	Connector	SMA Male (Brass)

## 7. Installation

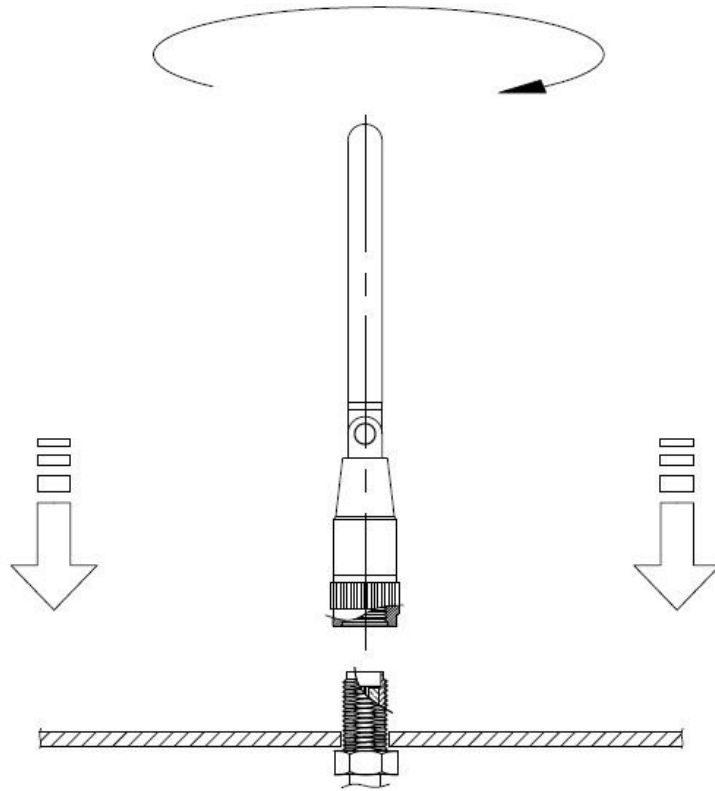

Recommended torque for mounting is 0.9 N·m  
Maximum torque for mounting is 1.176 N·m

## 8. Minimum Ground Plane for LTE Efficiency

Different Ground Plane lengths were considered for acceptable efficiency for LTE bands.

Three different ground planes were chosen. They were all 30mm wide and the lengths were varied beginning at 90mm then 70mm and finally 60mm

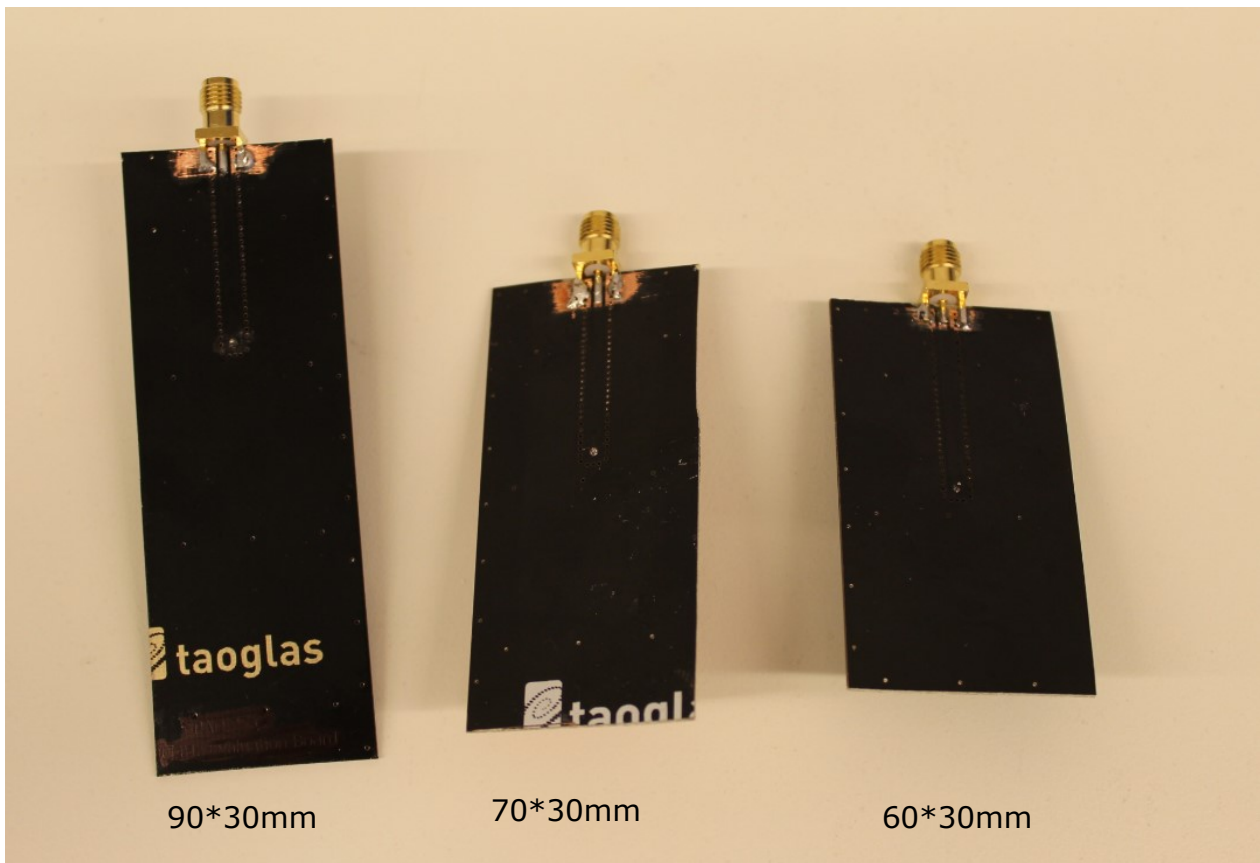

It was also considered whether the TG.09 antenna was positioned straight or at an angle of 90°.

The antenna was positioned on the edge of the Ground Plane for all tests.



Parameter										
Straight Pose										
Band	700 LTE	GSM	DCS	PCS	UMTS/ HSPA	2300 LTE	2700 LTE	3500 LTE	3700LTE	
Frequency (MHz)	703~ 803	824~ 960	1710~ 1880	1850~ 1990	1920~ 2170	2300~ 2400	2490~ 2690	3400~3600	3600~ 3800	
Average Gain (dBi)	90*30mm Ground	-1.4	-3.2	-3.2	-1.9	-2.3	-5.1	-2.0	-3.8	-2.9
Efficiency (%)		72%	49%	48%	64%	59%	31%	63%	42%	54%
Peak Gain (dBi)		2.0	1.9	2.7	3.2	3.6	1.3	5.2	2.7	4.2
Return Loss (dB)		9	4.8	5.1	11.4	11.1	5.3	9.6	9.5	7.9
Average Gain (dBi)	70* 30mm Ground	-2.7	-2.7	-3.4	-2.2	-1.8	-5.7	-1.5	-3.9	-2.0
Efficiency (%)		53%	54%	45%	60%	67%	28%	70%	42%	62%
Peak Gain (dBi)		1.8	2.0	1.5	3.5	4.3	1.7	4.3	3.7	5.0
Return Loss (dB)		7.3	7.1	4.2	7.3	12.4	4.4	14.7	8.9	9.9
Average Gain (dBi)	60* 30mm Ground	-3.9	-2.9	-2.9	-2.4	-1.6	-7.3	-1.4	-4.3	-3.0
Efficiency (%)		41%	50%	51%	58%	69%	20%	72%	37%	49%
Peak Gain (dBi)		1.1	1.3	2.1	3.0	4.1	0.4	4.5	3.0	4.5
Return Loss (dB)		6.5	7.7	5.0	6.4	9.9	3.4	12.4	6.3	6.4
90° Bend Pose										
Average Gain (dBi)	90*30mm Ground	-1.7	-2.4	-3.5	-2.1	-2.1	-5.3	-2.1	-3.3	-2.6
Efficiency (%)		68%	58%	45%	61%	61%	30%	61%	47%	54%
Peak Gain (dBi)		2.7	2.5	2.1	3.1	3.5	1.6	5.2	3.4	4.3
Return Loss (dB)		7.5	7.6	4.5	9.1	12.5	5.1	8.7	12.3	7.8
Average Gain (dBi)	70*30mm Ground	-4.2	-2.3	-3.7	-2.5	-1.8	-4.6	-1.5	-3.4	-2.0
Efficiency (%)		39%	59%	42%	56%	67%	35%	70%	46%	62%
Peak Gain (dBi)		1.4	1.7	1.4	3.2	4.3	2.1	4.1	4.1	5.1
Return Loss (dB)		4.9	11.2	3.9	6.4	13.5	5.2	12.6	10.6	9.5
Average Gain (dBi)	60*30mm Ground	-5.6	-3.0	-3.2	-2.6	-1.7	-5.9	-1.4	-3.9	-3.1
Efficiency (%)		28%	50%	47%	54%	68%	26%	73%	41%	49%
Peak Gain (dBi)		0.0	1.0	1.8	3.0	3.8	1.1	4.3	3.3	4.5
Return Loss (dB)		4.4	11.5	4.6	6.0	10.8	3.9	11.2	7.0	6.2

## 8.1 Return Loss

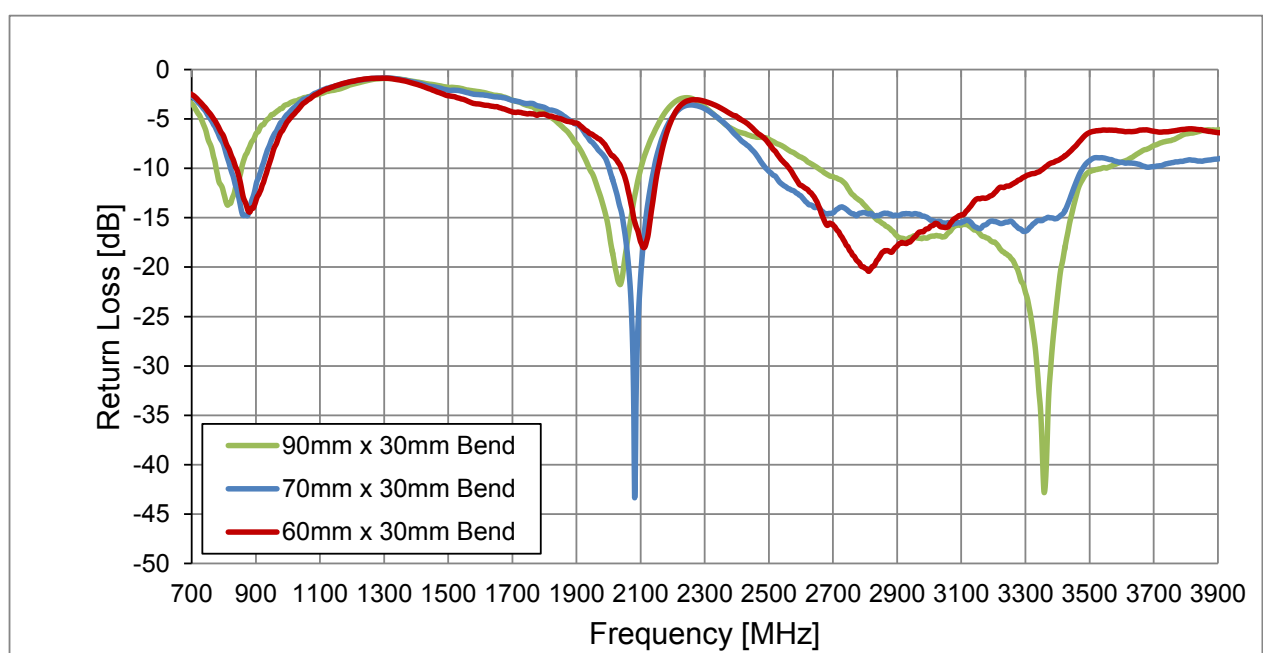
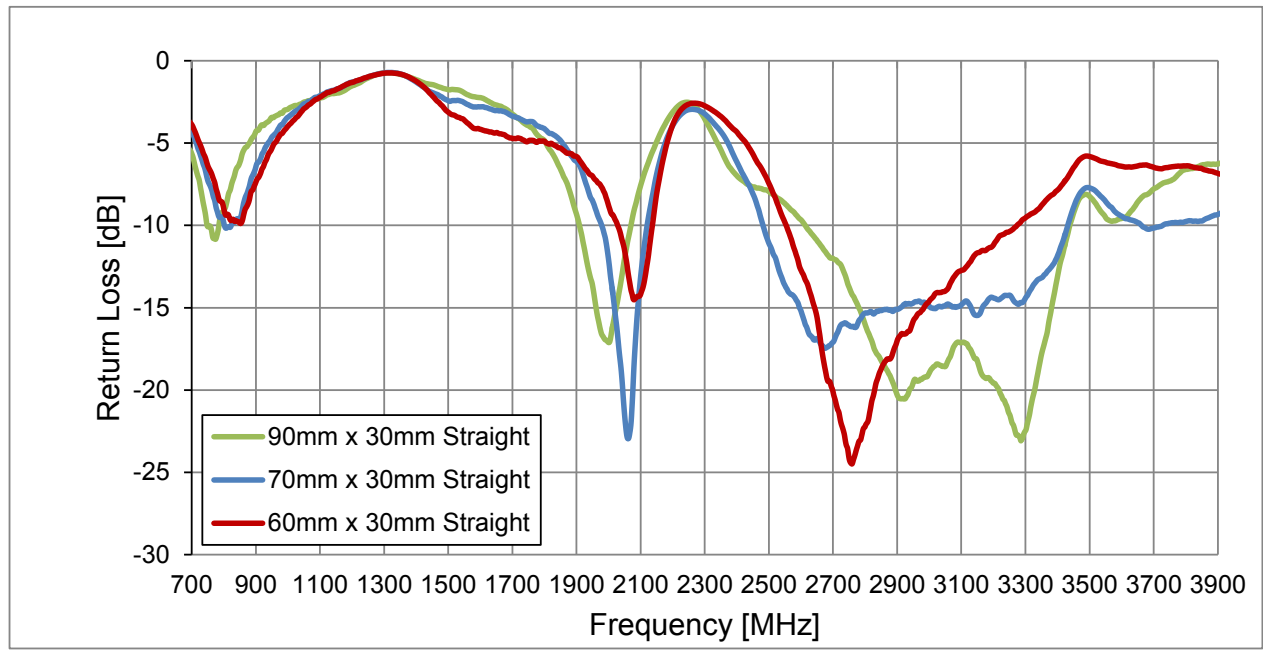

## 8.2 VSWR

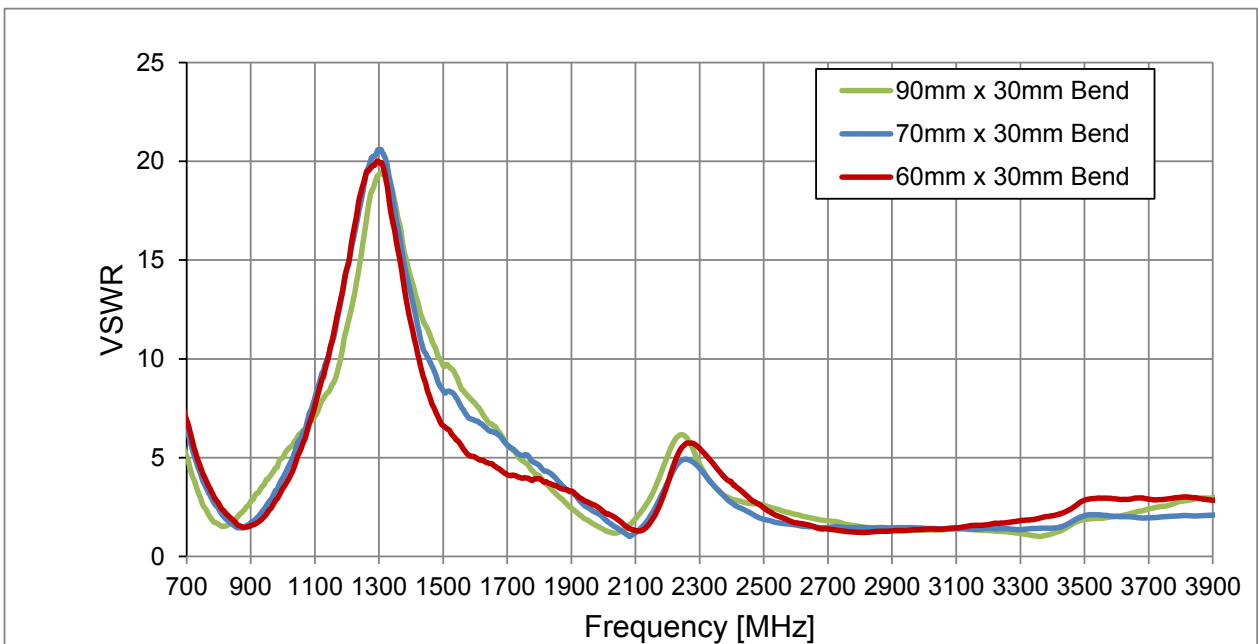
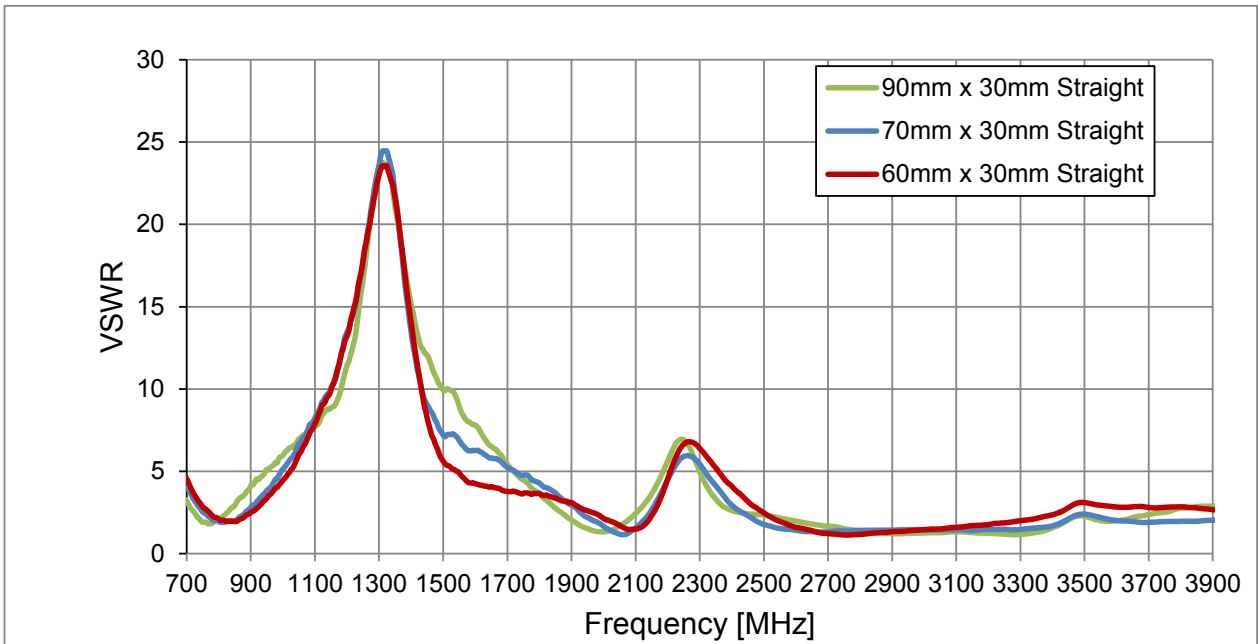



### 8.3 Efficiency for Straight Antenna

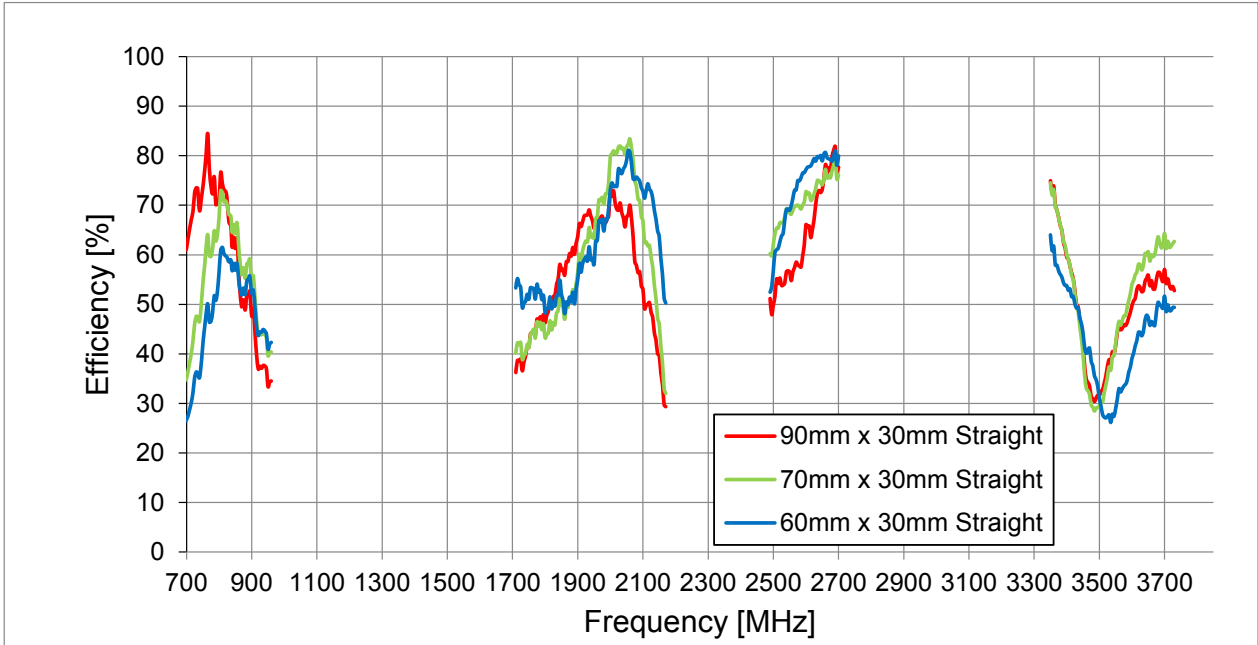

### 8.4 Peak Gain for Straight Antenna

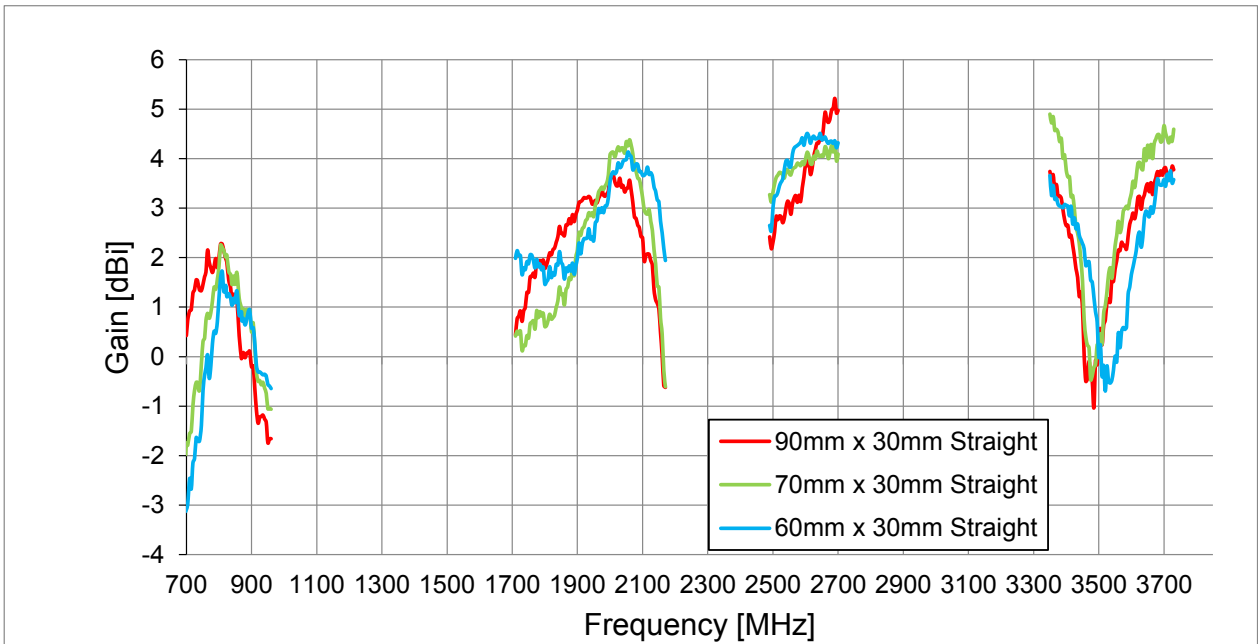

## 8.5 Average Gain for Straight Antenna

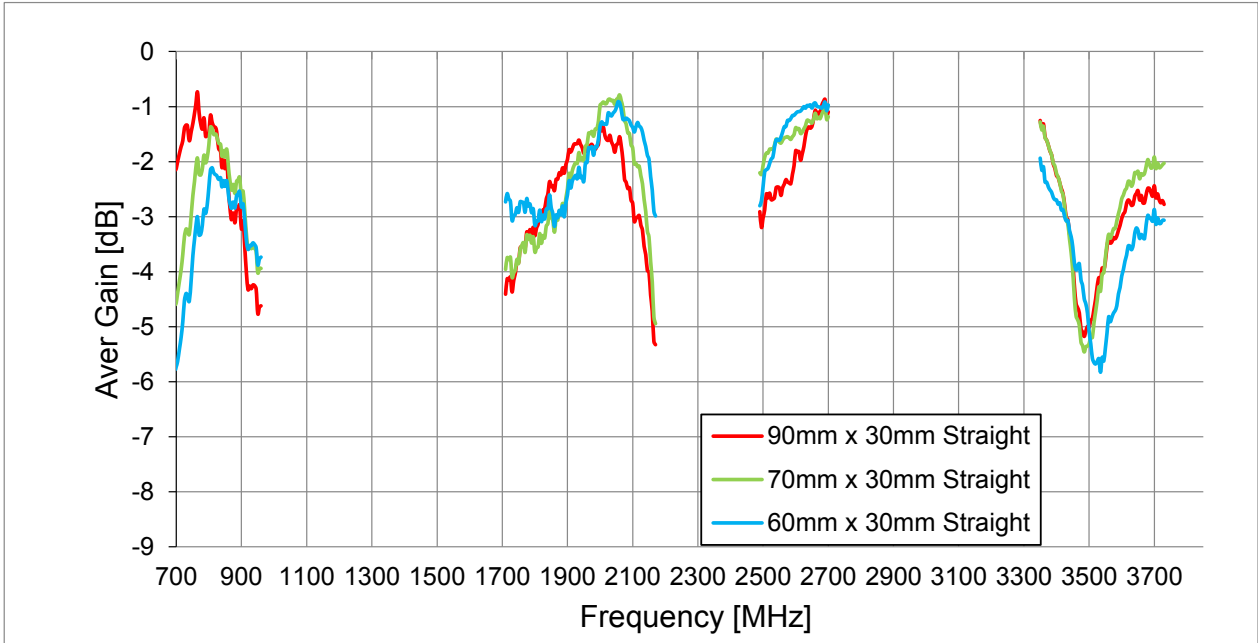

## 8.6 Efficiency for 90° Bend

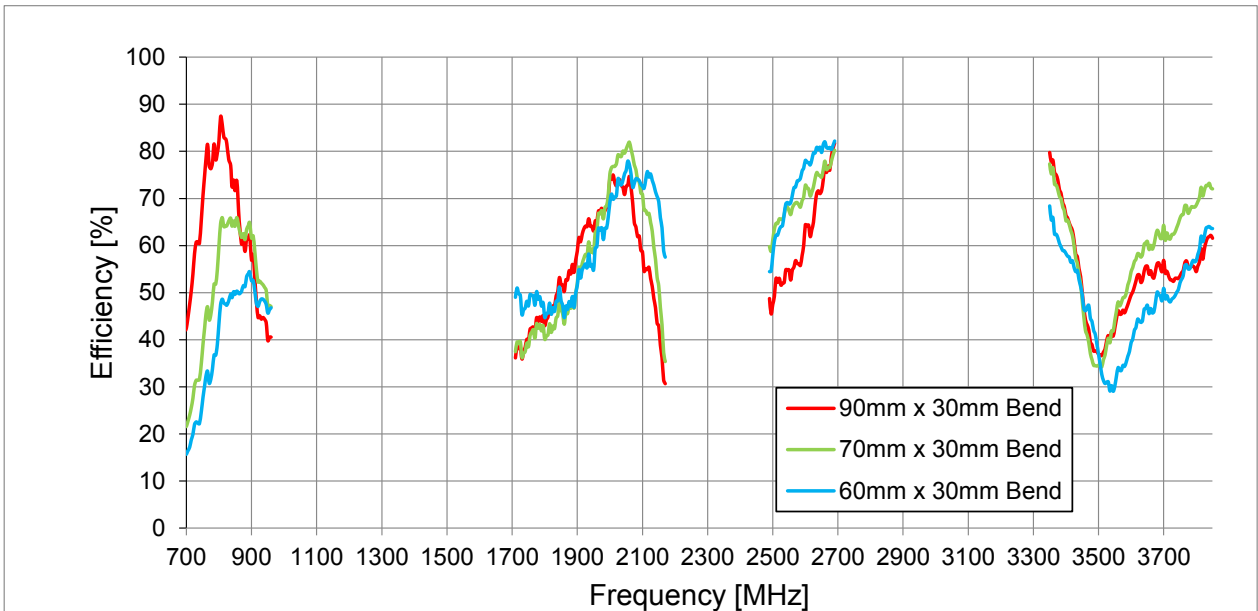

### 8.7 Peak Gain for 90° Bend

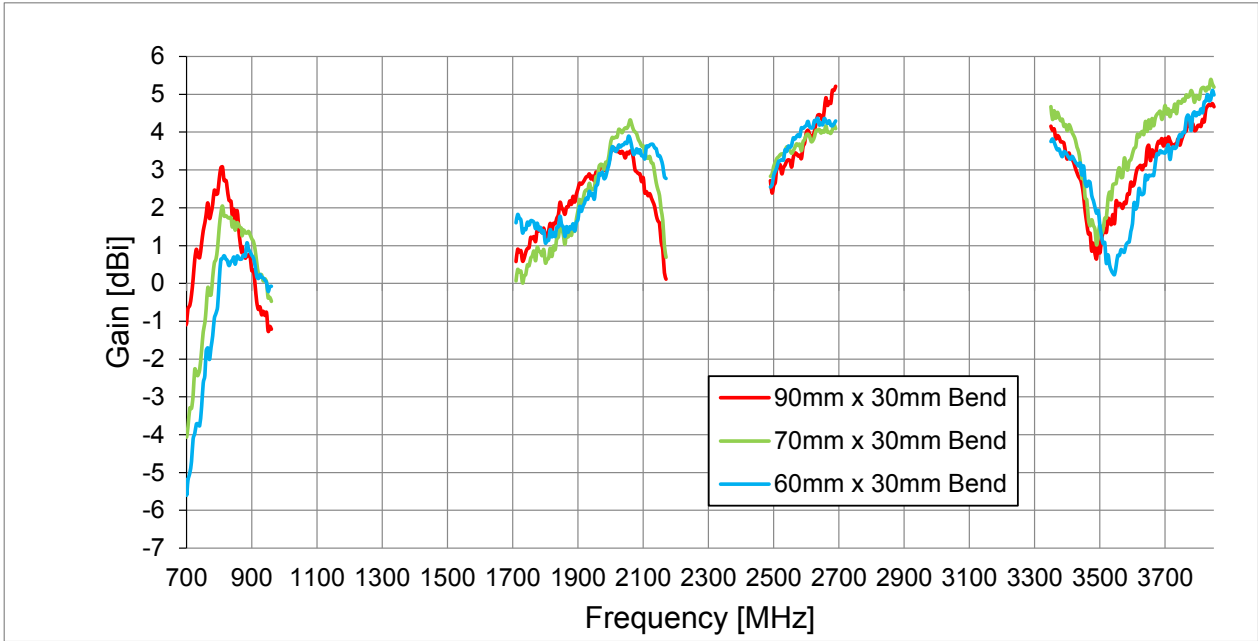

### 8.8 Average Gain for 90° Bend

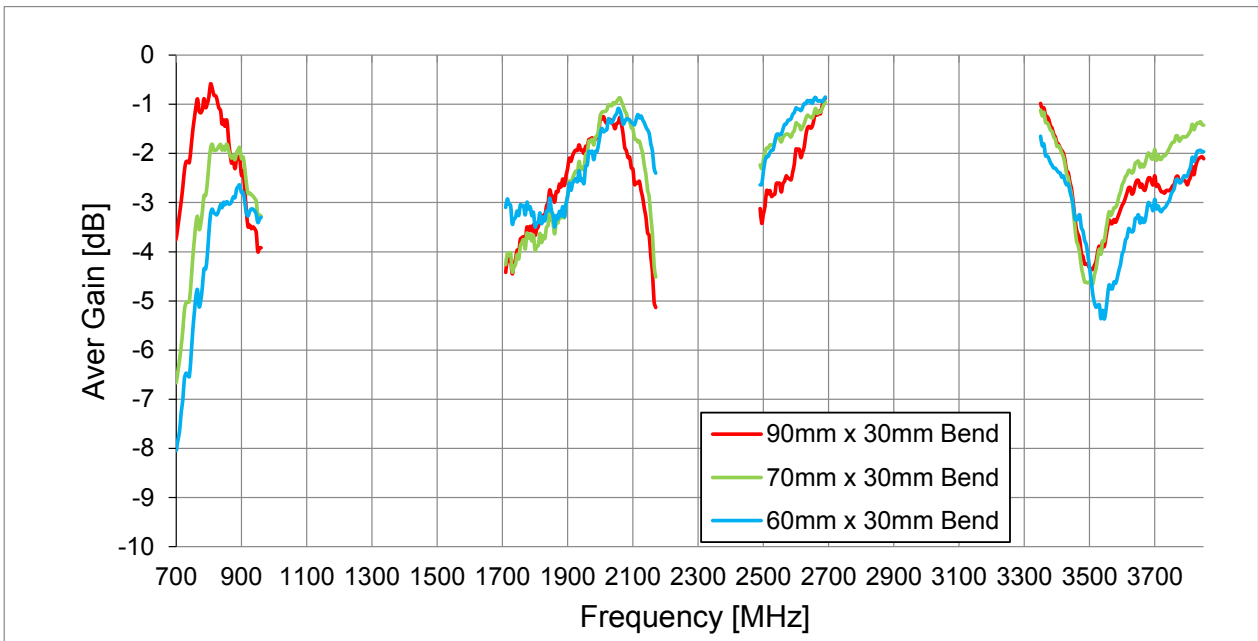

## 9. Packaging

1 pc TG.09.0113 per small zipper bag  
 PE Bag Dimensions - 74\*42mm  
 Weight - 8.6g

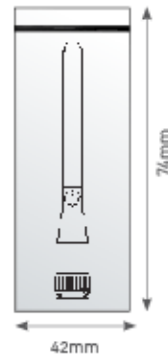

100 PE bags per large PE bags  
 100 pcs TG.09.0113 per large PE bags  
 Weight - .86kg

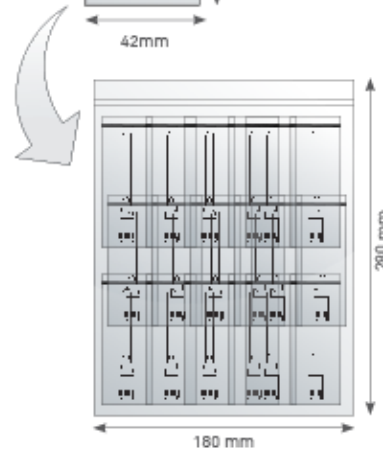

1500 pcs TG.09.0113 per carton  
 Carton Dimensions - 360\*310\*160mm  
 Weight - 13.6kg

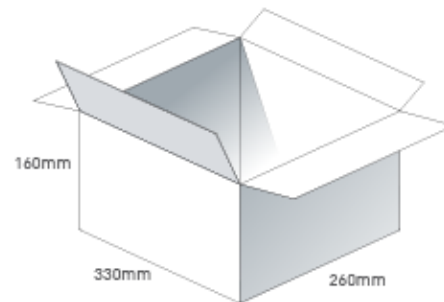

Pallet Dimensions 1080\*930\*1430mm  
 72 Cartons per Pallet  
 6 Cartons per layer  
 12 Layers

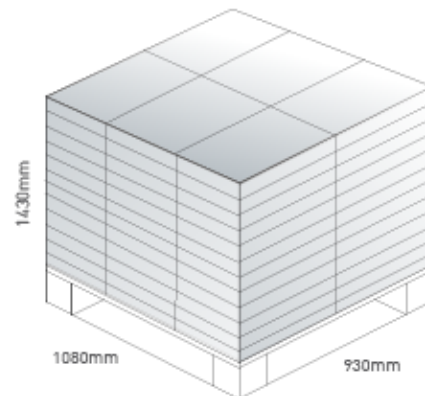



Taoglas makes no warranties based on the accuracy or completeness of the contents of this document and reserves the right to make changes to specifications and product descriptions at any time without notice. Taoglas reserves all rights to this document and the information contained herein.

Reproduction, use or disclosure to third parties without express permission is strictly prohibited.

Copyright © Taoglas Ltd.

# Mouser Electronics

Authorized Distributor

Click to View Pricing, Inventory, Delivery & Lifecycle Information:

[Taoglas:](#)

[TG.09.0113w](#)