

Parameter	Rating	Units
LED Operating Range	2-10	mA
K3, Transfer Gain	0.773-1.072	-
Isolation, Input to Output	3750	V _{rms}

Features

- 0.01% Servo Linearity
- THD -87dB Typical
- Wide Bandwidth (>200kHz)
- Couples Analog and Digital Signals
- High Gain Stability
- Low Input/Output Capacitance
- Low Power Consumption
- 16-Pin SOIC Package (PCMCIA Compatible)
- Machine Insertable, Wave Solderable
- Surface Mount Tape & Reel Version Available

Applications

- Modem Transformer Replacement With No Insertion Loss
- Digital Telephone Isolation
- Power Supply Feedback Voltage/Current
- Medical Sensor Isolation
- Audio Signal Interfacing
- Isolation of Process Control Transducers

Pin Configuration

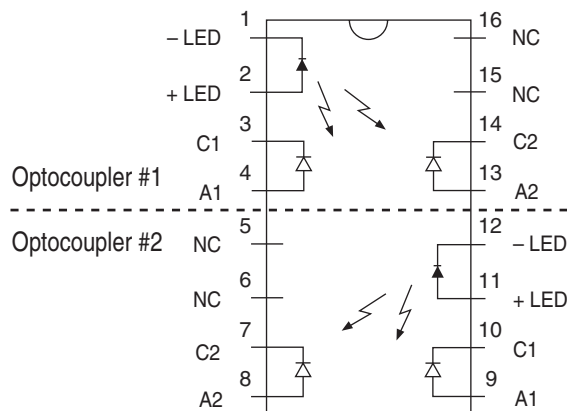

Description

The LOC211P Dual Linear Optocoupler features an infrared LED optically coupled with two photodiodes. A feedback (input) photodiode is used to generate a control signal that provides a servomechanism to the LED drive current, thus compensating for the LED's nonlinear time and temperature characteristics. The other (output) photodiode provides an output signal that is linear with respect to the servo LED current. The product features wide bandwidth, high input to output isolation, and excellent servo linearity.

Approvals

- UL Recognized Component: File # E76270
- CSA Certified Component: Certificate # 1175739
- EN/IEC 60950-1 Certified Component:
TUV Certificate # B 13 12 82667 003

Ordering Information

Part #	Description
LOC211P	16-Pin SOIC (50/tube)
LOC211PTR	16-Pin SOIC (1000/Reel)

K3 Sorted Bins

Bin	K3 Range
Bin 1	0.773 - 0.886
Bin 2	0.887 - 1.072

Bin Matrix

Suffix	Top Pole Optocoupler*	Bottom Pole Optocoupler**
	Bin	
K	1	1
L	1	2
M	2	1
N	2	2

*Top Optocoupler: Pins 1,2,3,4,13, and 14

**Bottom Optocoupler: Pins 7 through 12

Part Number Information

The LOC211P is shipped in anti-static tubes (50 pieces each) or tape/reel (1,000 pieces each). Each container has only 1 bin combination which will be branded on each part with the appropriate bin letter K, L, M, or N in the lower right hand corner. Suffix representation is described in the "Bin Matrix".



Absolute Maximum Ratings @ 25°C

Parameter	Ratings	Units
Reverse LED Voltage	5	V
Input Control Current	100	mA
Peak (10ms)	1	A
Input Power Dissipation ¹	150	mW
Power Dissipation Total Package Dissipation ²	800	mW
Isolation Voltage, Input to Output	3750	V _{rms}
Operational Temperature	-40 to +85	°C
Storage Temperature	-40 to +125	°C

Absolute Maximum Ratings are stress ratings. Stresses in excess of these ratings can cause permanent damage to the device. Functional operation of the device at conditions beyond those indicated in the operational sections of this data sheet is not implied.

¹ Derate linearly 1.33 mW / °C

² Derate linearly 6.67 mW / °C

Electrical Characteristics @ 25°C

Parameter	Conditions	Symbol	Min	Typ	Max	Units
Input Characteristics						
LED Voltage Drop	I _F =2 - 10mA	V _F	0.9	1.2	1.4	V
Reverse LED Current	V _R =5V	I _R	-	-	10	μA
Coupler/Detector Characteristics						
Dark Current	I _F =0mA, V _{C1-A1} =V _{C2-A2} =15V	I _D	-	1	25	nA
K1, Servo Gain (I _{C1} /I _F)	I _F =2 - 10mA, V _{C1-A1} =V _{C2-A2} =15V	K1	0.008	-	0.030	-
K2, Forward Gain (I _{C2} /I _F)		K2	0.006	-	0.030	-
K3, Transfer Gain (K2/K1=I _{C2} /I _{C1})		K3	0.773	-	1.072	-
ΔK3, Transfer Gain Linearity (non-servoed)	I _F =2 - 10mA	ΔK3	-	-	1	%
K3 Temperature Coefficient	I _F =2 - 10mA, V _{C1-A1} =V _{C2-A2} = 5V	ΔK3/ΔT	-	0.005	-	%/°C
Common Mode Rejection Ratio	V=20V _{p,p} , R _L =2kΩ, f=100Hz	CMRR	-	130	-	dB
Total Harmonic Distortion	f ₀ =350Hz, 0dBm	THD	-96	-87	-80	dB
Frequency Response ²	Photoconductive Configuration	f _{-3dB}	-	200	-	kHz
	Photovoltaic Configuration		-	40	-	kHz
Common Characteristics						
Input/Output Capacitance	-	C _{IO}	-	3	-	pF

¹ All parameters above are for each optocoupler.

² See Application Note, AN-107, for LOC211P configurations.

PERFORMANCE DATA @25°C (Unless Otherwise Noted)*

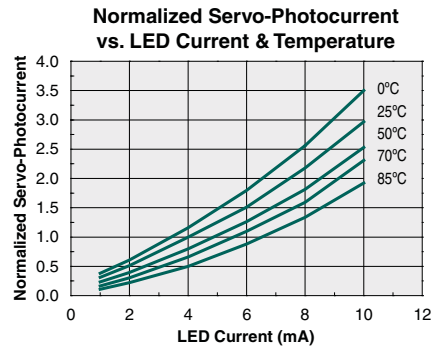
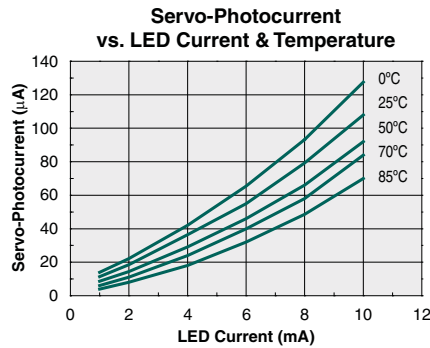
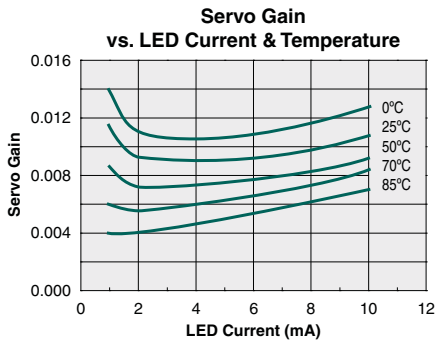
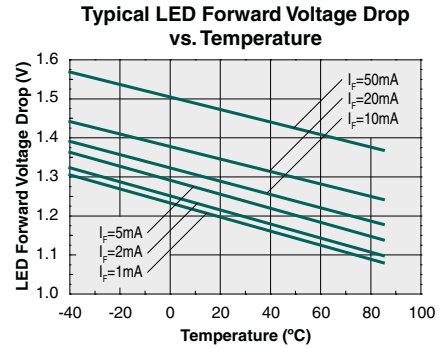
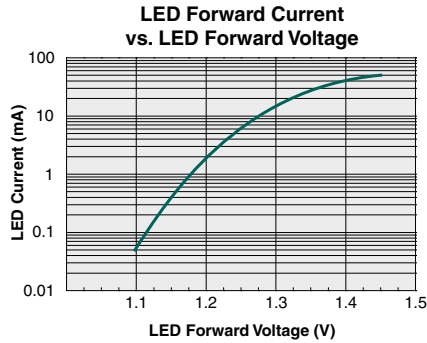
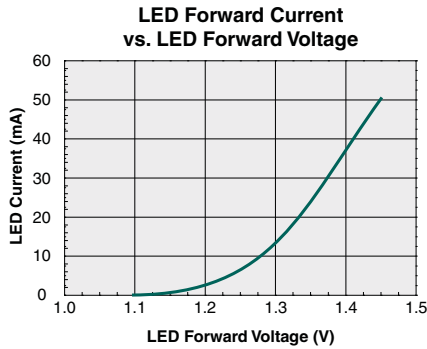

*The Performance data shown in the graphs above is typical of device performance. For guaranteed parameters not indicated in the written specifications, please contact our application department.

Manufacturing Information

Moisture Sensitivity



All plastic encapsulated semiconductor packages are susceptible to moisture ingress. IXYS Integrated Circuits Division classified all of its plastic encapsulated devices for moisture sensitivity according to the latest version of the joint industry standard, **IPC/JEDEC J-STD-020**, in force at the time of product evaluation. We test all of our products to the maximum conditions set forth in the standard, and guarantee proper operation of our devices when handled according to the limitations and information in that standard as well as to any limitations set forth in the information or standards referenced below.

Failure to adhere to the warnings or limitations as established by the listed specifications could result in reduced product performance, reduction of operable life, and/or reduction of overall reliability.

This product carries a **Moisture Sensitivity Level (MSL) rating** as shown below, and should be handled according to the requirements of the latest version of the joint industry standard **IPC/JEDEC J-STD-033**.

Device	Moisture Sensitivity Level (MSL) Rating
LOC211P	MSL 1

ESD Sensitivity



This product is **ESD Sensitive**, and should be handled according to the industry standard **JESD-625**.

Soldering Profile

This product has a maximum body temperature and time rating as shown below. All other guidelines of **J-STD-020** must be observed.

Device	Maximum Temperature x Time
LOC211P	260°C for 30 seconds

Board Wash

IXYS Integrated Circuits Division recommends the use of no-clean flux formulations. However, board washing to remove flux residue is acceptable. Since IXYS Integrated Circuits Division employs the use of silicone coating as an optical waveguide in many of its optically isolated products, the use of a short drying bake could be necessary if a wash is used after solder reflow processes. Chlorine- or Fluorine-based solvents or fluxes should not be used. Cleaning methods that employ ultrasonic energy should not be used.



Mechanical Dimensions

LOC211P

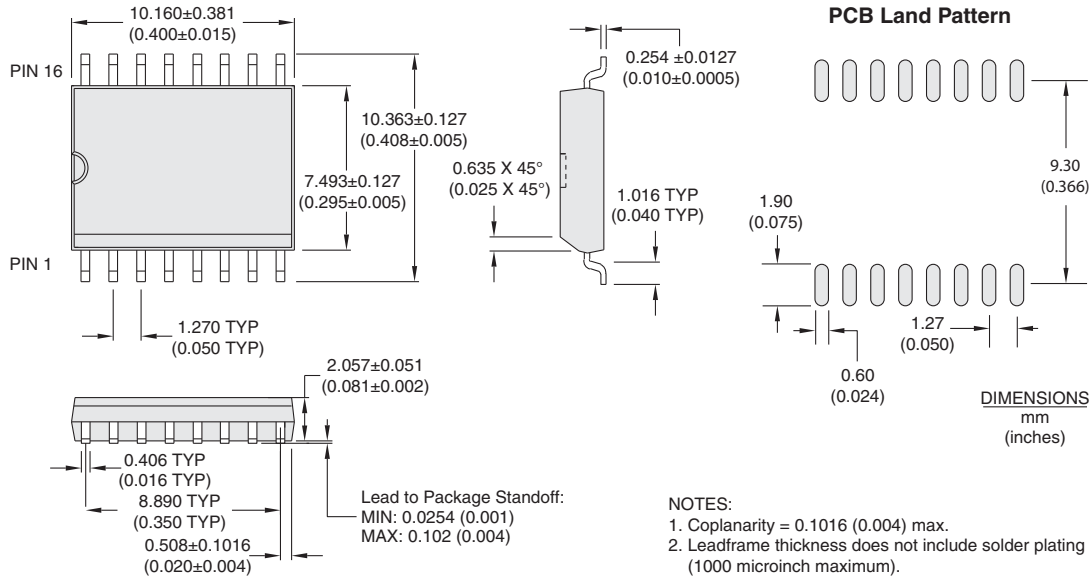

LOC211PTR Tape & Reel

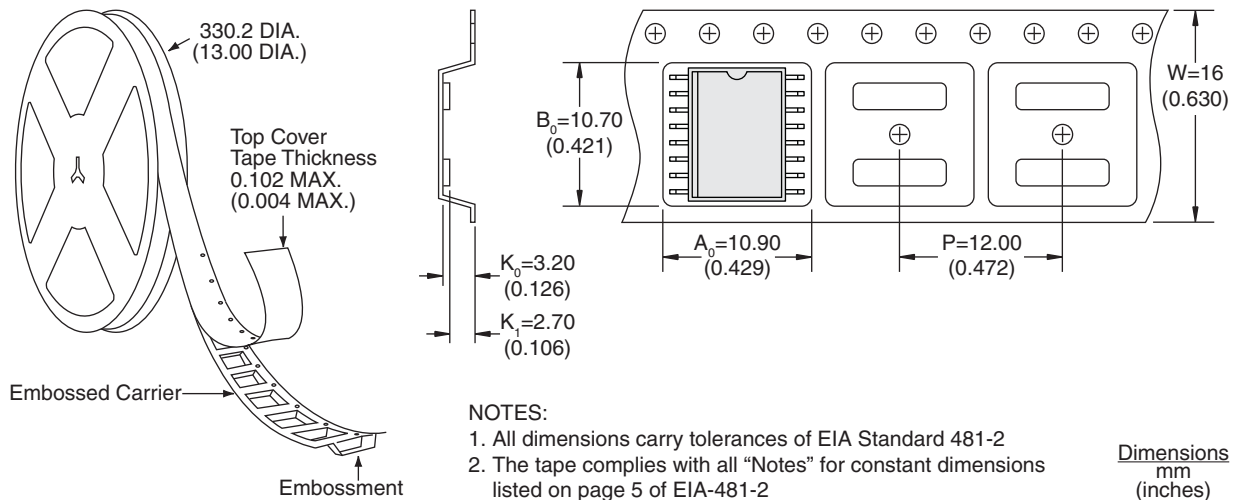

For additional information please visit our website at: www.ixysic.com

IXYS Integrated Circuits Division makes no representations or warranties with respect to the accuracy or completeness of the contents of this publication and reserves the right to make changes to specifications and product descriptions at any time without notice. Neither circuit patent licenses nor indemnity are expressed or implied. Except as set forth in IXYS Integrated Circuits Division's Standard Terms and Conditions of Sale, IXYS Integrated Circuits Division assumes no liability whatsoever, and disclaims any express or implied warranty, relating to its products including, but not limited to, the implied warranty of merchantability, fitness for a particular purpose, or infringement of any intellectual property right.

The products described in this document are not designed, intended, authorized or warranted for use as components in systems intended for surgical implant into the body, or in other applications intended to support or sustain life, or where malfunction of IXYS Integrated Circuits Division's product may result in direct physical harm, injury, or death to a person or severe property or environmental damage. IXYS Integrated Circuits Division reserves the right to discontinue or make changes to its products at any time without notice.

Mouser Electronics

Authorized Distributor

Click to View Pricing, Inventory, Delivery & Lifecycle Information:

[IXYS:](#)

[LOC211P](#) [LOC211PTR](#)