

PART NAME

JUNCTION BOX

PART No.

JB-3958

REVISION DATE

7-18-11

MATERIAL - 16 GA. [1.5mm] STEEL
FINISH - SMOOTH GRAY POWDERCOAT

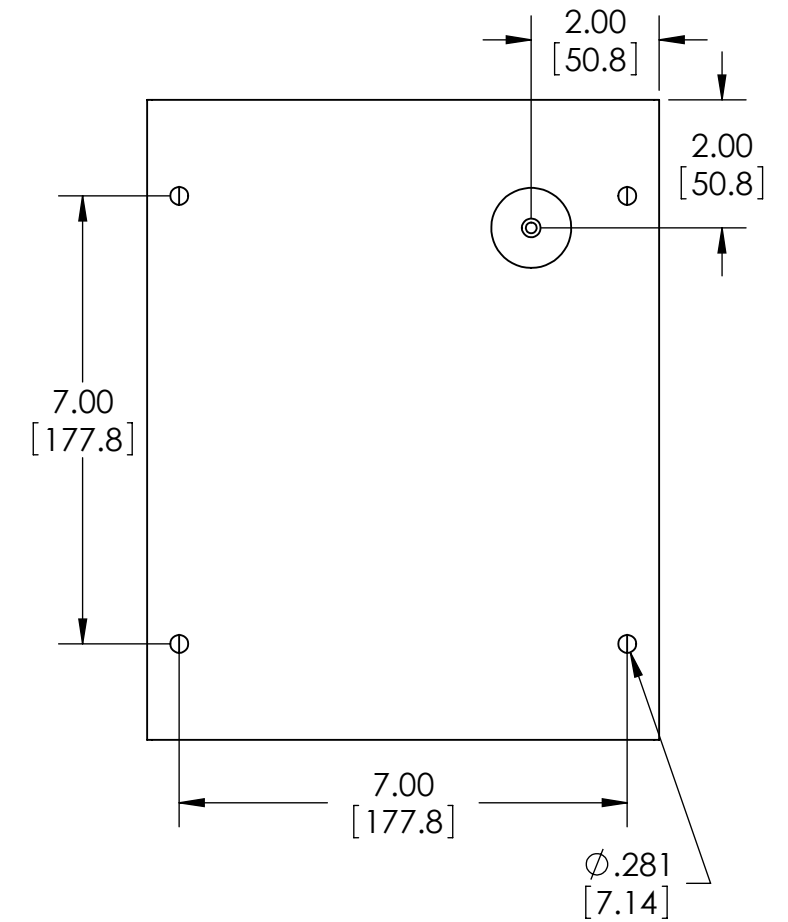
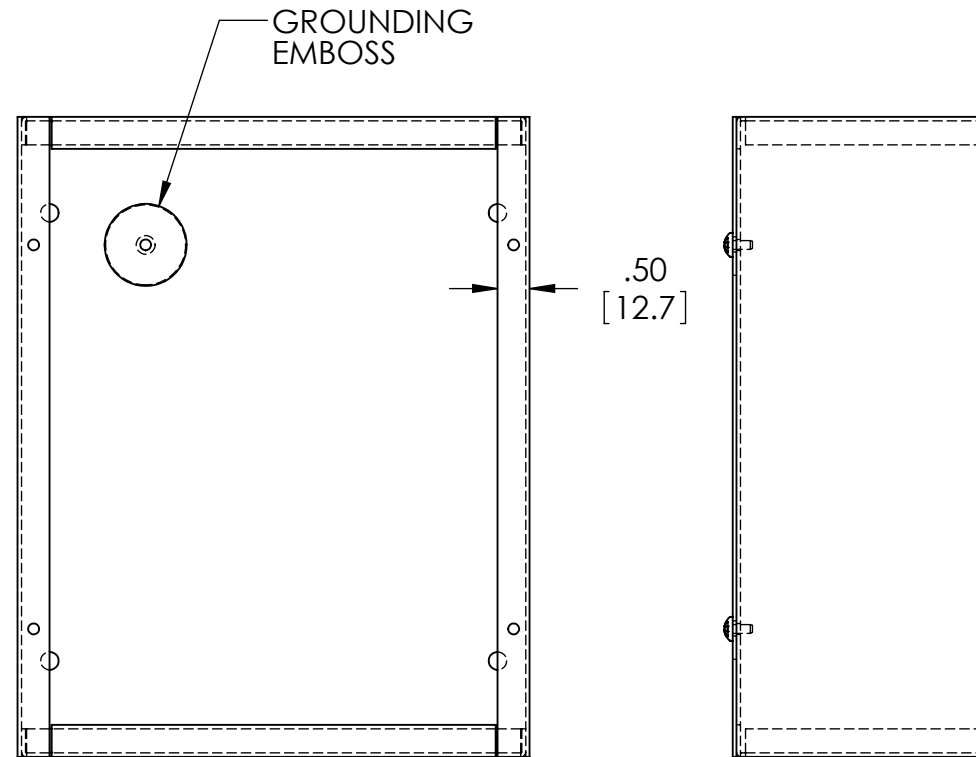
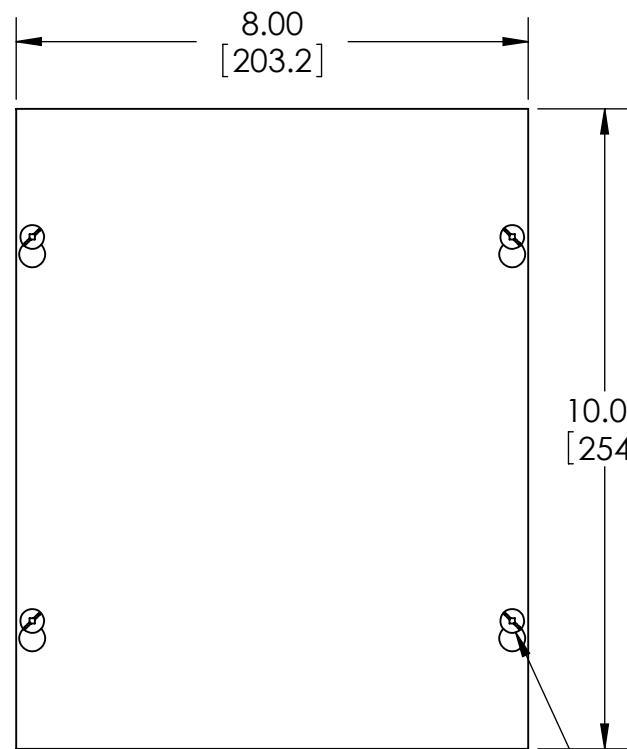
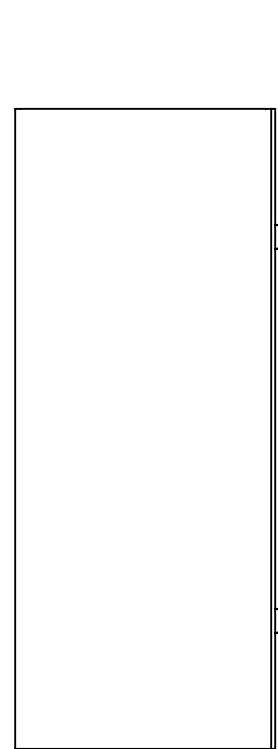
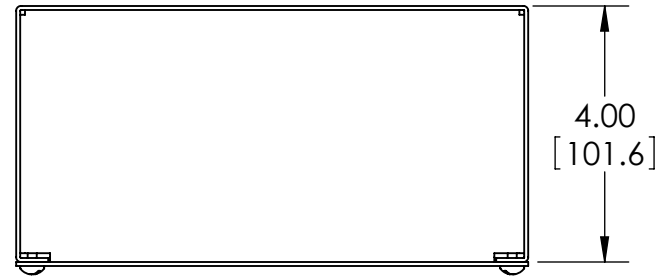
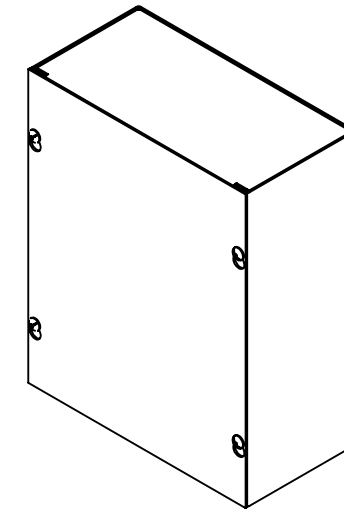

COVER REMOVED

SCREWS: #10-32 x .31"[8mm] LG.
MACHINE, PAN HEAD, SLOTTED/SQUARE
COMBINATION STYLE DRIVE, STEEL, ZINC PLATED.
(SUPPLIED FOR COVER MOUNTING AND
FOR GROUND POINT).

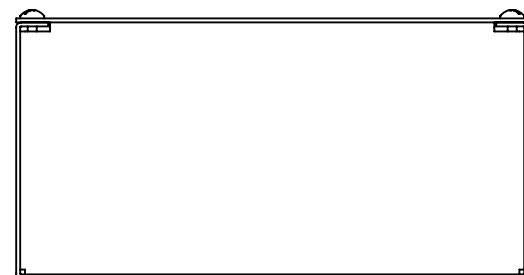

Mouser Electronics

Authorized Distributor

Click to View Pricing, Inventory, Delivery & Lifecycle Information:

[Bud Industries:](#)

[JB-3958](#) [JB-3958-KO](#)