

TUNING FORK CRYSTAL UNIT (SMD · Cylinder Type)

RoHS compliant / Pb free

CMR200T

2,000pcs/reel



■ FEATURES

- Reflowable cylinder type
- Frequency range : 32.768kHz
- External dimensions (mm)
Φ : 2.0 x L : 6.1
- Applications
Smart Meters / Consumer products

■ DIMENSION [mm]

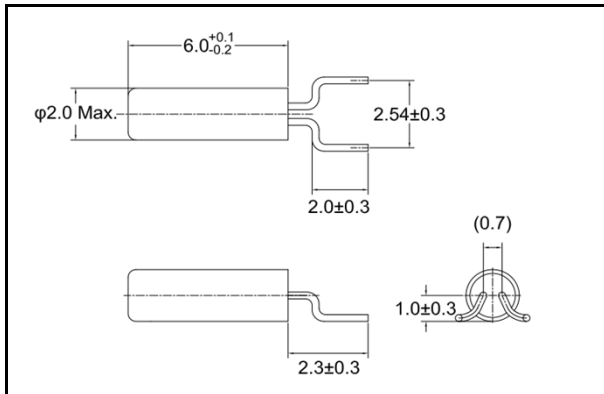

■ SOLDER PAD LAYOUT [mm]

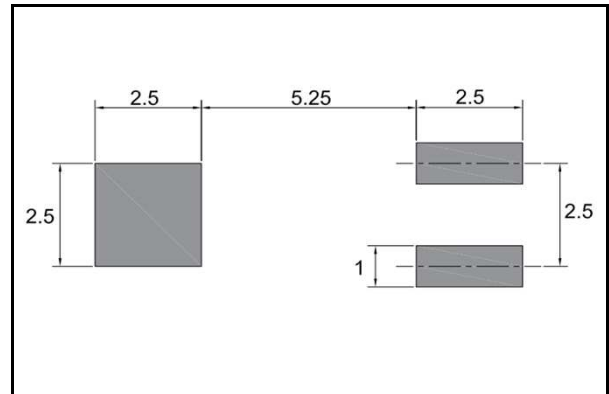

■ STANDARD SPECIFICATIONS

Item	Model	CMR200T	Conditions
Nominal Frequency	f_0	32.768kHz	
Frequency Tolerance	$\Delta f/f_0$	$\pm 10\text{ppm} / \pm 20\text{ppm}$	at 25°C
Load capacitance	C_L	6.0pF / 7.0pF / 12.5pF	Please specify your requirement
Operating Temperature Range	T_{OPR}	-40°C ~ +85°C	
Storage Temperature Range	T_{STR}	-55°C ~ +125°C	
Turnover Temperature	T_M	25°C ± 5°C	
Temperature Coefficient	β	$-0.034 \pm 0.006\text{ppm}/^\circ\text{C}^2$	
Motional (series) resistance	R_1	50K Ω Max.	at 25°C
Level of drive	D_L	1 μW Max.	
Aging (first year)	$\Delta f/f_0$	$\pm 3\text{ppm Max.}$	25°C ± 3°C
Shunt capacitance	C_0	1.35pF Typ.	

■ PART NUMBERING SYSTEM

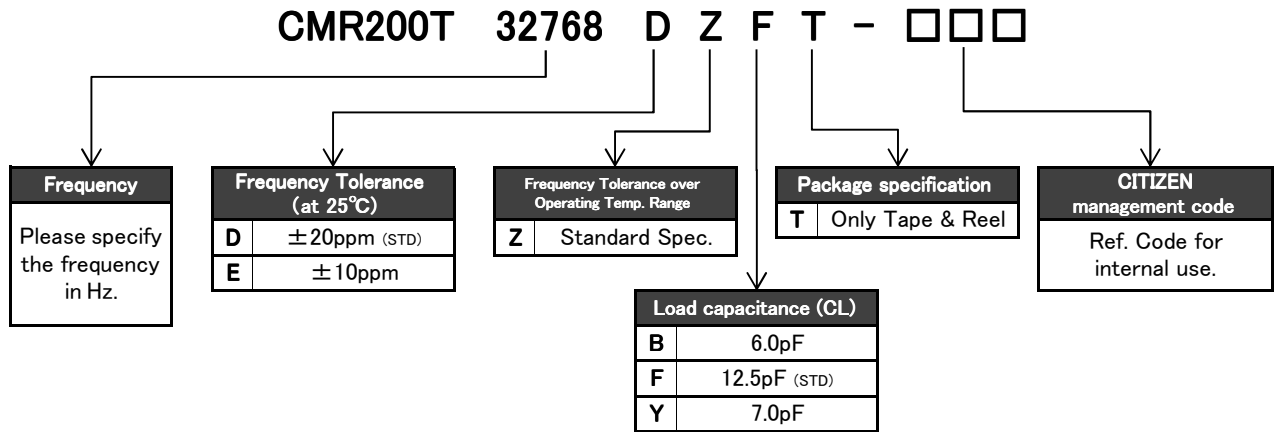

*Please contact us for specifications available.

■ Part Marking [standard]

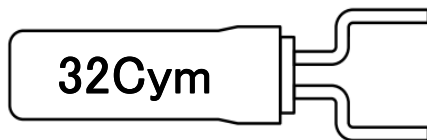

32C : Manufacture's ID Code

y : The last digit of production year

m : Production month (See Table.1)

Table.1

Month	Jan	Feb	...	Sep	Oct	Nov	Dec
Code	1	2	...	9	X	Y	Z

■ Reflow profile

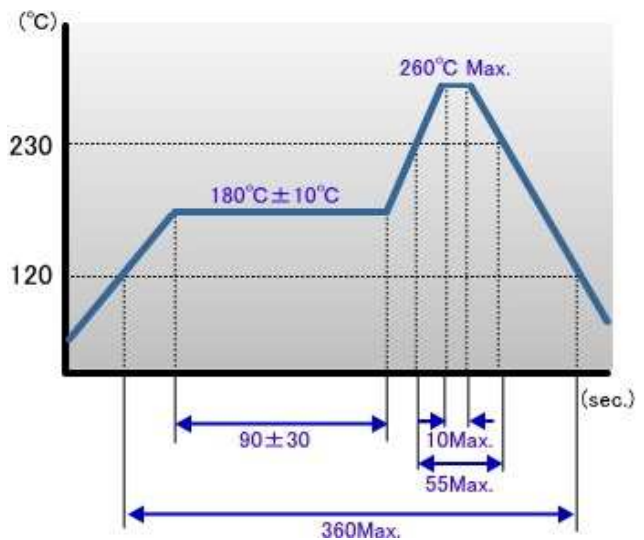

■ Packing

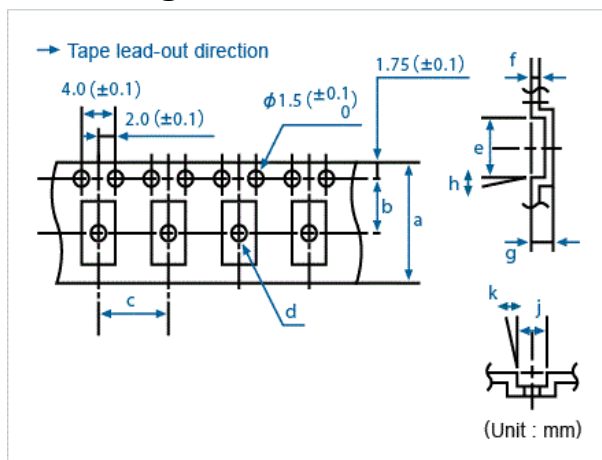

Conforming to JIS C 0806 TB1208NEIAJ and RC-1009B TE1208N

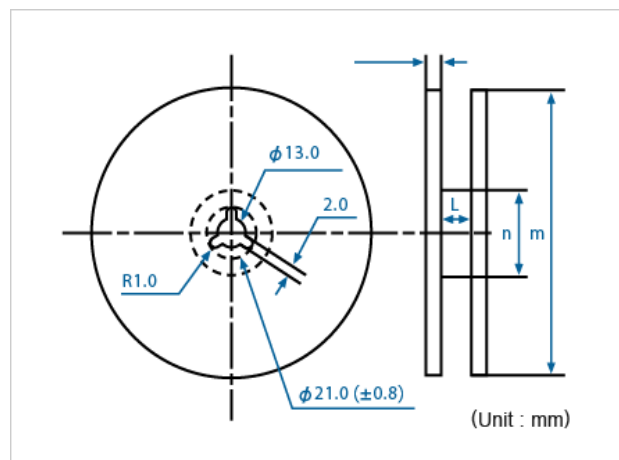

Conforming to JIS C 0806 R12R and EIAJ RC-1009B R15

Q'ty/reel	a	b	c	d (φ)	e	f	g	h	j	k	l	m (φ)	n (φ)
2,000	16.0	7.5	8.0	-	9.4	0.3	2.15	-	5.0	-	17.5	330	100

Product specifications are subject to change without notice.

Rev.2

Mouser Electronics

Authorized Distributor

Click to View Pricing, Inventory, Delivery & Lifecycle Information:

Citizen:

[CMR200T-32.768KDZF-UT](#) [CMR200T-32.768KDZB-UT](#) [CMR200T-32.768KDZY-UT](#) [CMR200T-B32.768KDZBTR](#)
[CMR200T32768DZBT](#) [CMR200T32768DZFT](#) [CMR200T32768DZYT](#)