

THIS DRAWING IS UNPUBLISHED.

RELEASED FOR PUBLICATION

© COPYRIGHT - BY - TE CONNECTIVITY

ALL RIGHTS RESERVED.

LOC - -

DIST - -

REVISIONS

P	LTR	DESCRIPTION	DATE	DWN	APVD
F		ECR-15-007519	19AUG2015	A.Q	D.Z
G		ECR-15-015566	19OCT2015	A.Q	D.Z
GI		ECR-17-017050	23NOV2017	C.X	D.Z

(2 POS.)

(6 POS.)

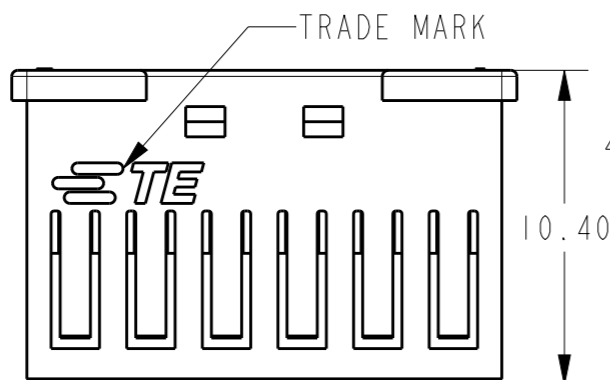
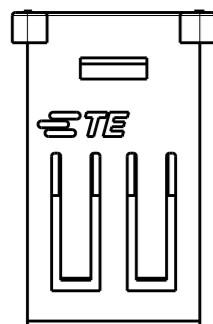

Notes:
 1 GENERAL TOLERANCE $\pm 0.3, \pm 3^\circ$
 2 MATERIAL: PA66 GF(UL94V-0)
 3 6-1971793-1 AS SHOWN ARE ONLY FOR P/N IN TABLE I
 4 APPLICABLE CONTACT P/N: 1971795-1
 5 RESTRICTED TO SPECIAL CUSTOMER (HAIER)

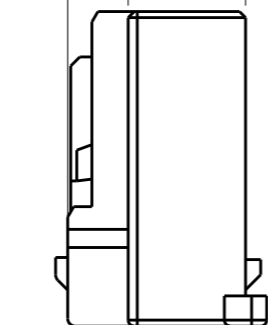
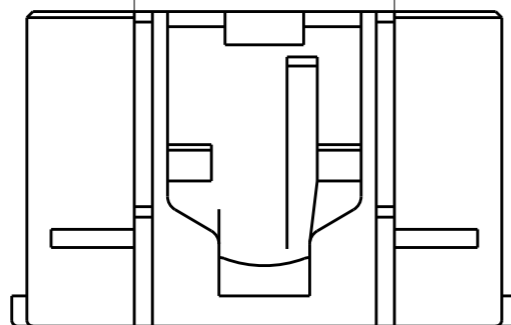
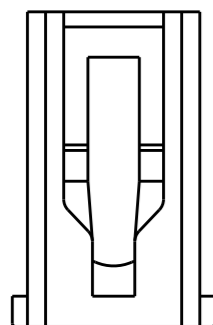
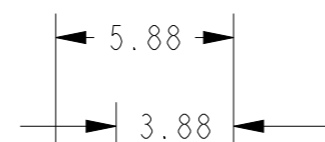
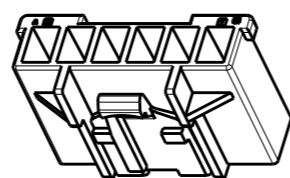
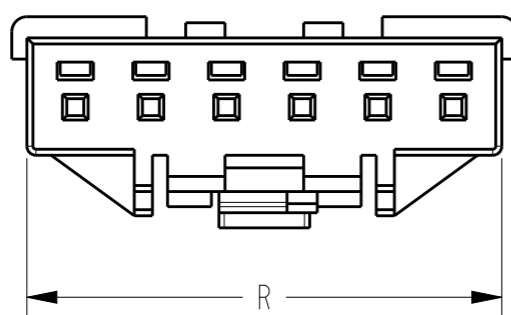
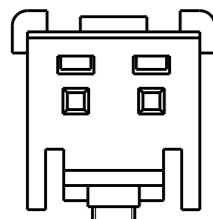

MATING CONN P/N	COLOR	KEYING	R	M	P	N(POS.)	P/N
3-1971798-4	YELLOW	D	8.2	5	6.2	3	3-2232701-4
3-1971798-2	BLUE	B					3-2232701-2
2-1971798-1	NATURAL	A	5.7	2.5	5.7	2	2-2232701-1
6-1971798-X 6-1971800-X	NATURAL	NA	15.7	12.5	8.6	6	6-1971793-6
	BLACK	D					6-1971793-5
	YELLOW	D					6-1971793-4
	RED	C					6-1971793-3
	BLUE	B					6-1971793-2
	NATURAL	A					6-1971793-1
5-1971798-X 5-1971800-X	BLACK	D	13.2	10	8.6	5	5-1971793-5
	YELLOW	D					5-1971793-4
	RED	C					5-1971793-3
	BLUE	B					5-1971793-2
	NATURAL	A					5-1971793-1
4-1971798-X 4-1971800-X	BLACK	D	10.7	7.5	7.4	4	4-1971793-5
	YELLOW	D					4-1971793-4
	RED	C					4-1971793-3
	BLUE	B					4-1971793-2
3-1971798-X 3-1971800-X	NATURAL	A	8.2	5	6.2	3	4-1971793-1
	BLACK	D					3-1971793-5
	YELLOW	D					3-1971793-4
	RED	C					3-1971793-3
	BLUE	B					3-1971793-2
2-1971798-X 2-1971800-X	NATURAL	A	5.7	2.5	5.7	2	3-1971793-1
	BLACK	D					2-1971793-5
	YELLOW	D					2-1971793-4
	RED	C					2-1971793-3
	BLUE	B					2-1971793-2
	NATURAL	A					2-1971793-1

$M = 2.5 \times (N - 1)$
 2.50 Pitch

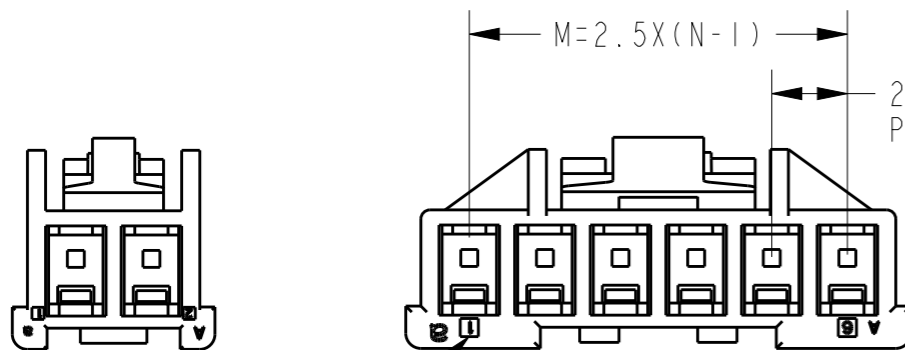

CIRCUIT NO. 1

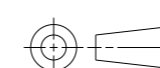
THIS DRAWING IS A CONTROLLED DOCUMENT.		DWN HJ.Z 28MAY2013	 TE Connectivity	NAME			
DIMENSIONS: mm		CHK HJ.Z 28MAY2013		NEXT GENERATION GRACE INERTIA CONNECTOR 2.5 PLUG HOUSING			
		APVD YH.M 28MAY2013		SIZE A3	CAGE CODE -	DRAWING NO. C-1971793	RESTRICTED TO -
TOLERANCES UNLESS OTHERWISE SPECIFIED:		PRODUCT SPEC 108-106077		SCALE 5:1 SHEET 1 OF 3 REV GI			
0 PLC ± 0.3 1 PLC ± 0.3 2 PLC ± 0.13 3 PLC ± 0.013 4 PLC $\pm 0.000J$ ANGLES ± 3		APPLICATION SPEC 114-106077	Customer Drawing				
MATERIAL SEE NOTE		WEIGHT -					

THIS DRAWING IS UNPUBLISHED.

RELEASED FOR PUBLICATION

20

© COPYRIGHT 20 BY -

ALL RIGHTS RESERVED.

LOC	DIST	REVISIONS					
		P	LTR	DESCRIPTION	DATE	DWN	APVD
-	-		-	SEE SHEET 1	-	-	-

7-1971793-1 AS SHOWN FOR P/N IN TABLE 2

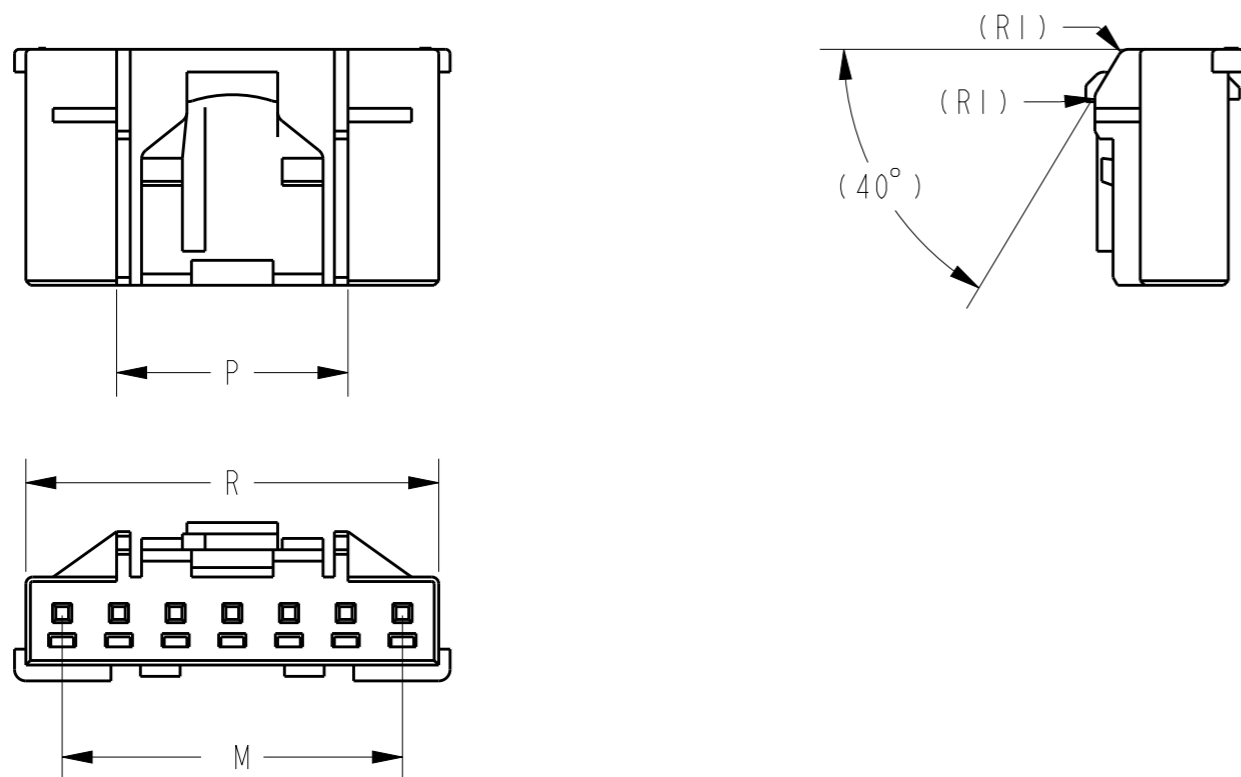

Notes:
 1 DIMENSIONS SHOWING IN SHEET 2 ARE ONLY FOR P/N IN TABLE 2
 2 DIMENSIONS NOT SHOWING IN SHEET 2 ARE THE SAME WITH DIMENSIONS IN SHEET 1

TABLE 2							
MATING CONN P/N	COLOR	KEYING	R	M	P	N (POS.)	P/N
8-1971798-X 8-1971800-X	BLACK	D	20.7	17.5	10.2	8	8-1971793-5
	YELLOW	D					8-1971793-4
	RED	C					8-1971793-3
	BLUE	B					8-1971793-2
	NATURAL	A					8-1971793-1
7-1971798-X 7-1971800-X	BLACK	D	18.2	15	10.2	7	7-1971793-5
	YELLOW	D					7-1971793-4
	RED	C					7-1971793-3
	BLUE	B					7-1971793-2
	NATURAL	A					7-1971793-1

THIS DRAWING IS A CONTROLLED DOCUMENT.		DWN ANNIE QIAN 08MAY2015	 TE Connectivity													
DIMENSIONS: mm		CHK ANNIE QIAN 08MAY2015														
TOLERANCES UNLESS OTHERWISE SPECIFIED		APVD DANIEL AHGN 08MAY2015	NAME NEXT GENERATION GRACE INERTIA CONNECTOR 2.5 PLUG HOUSING													
<table border="1"> <tr> <td>0 PLC</td> <td>±</td> </tr> <tr> <td>1 PLC</td> <td>±0.3</td> </tr> <tr> <td>2 PLC</td> <td>±0.13</td> </tr> <tr> <td>3 PLC</td> <td>±0.013</td> </tr> <tr> <td>4 PLC</td> <td>±0.000J</td> </tr> <tr> <td>ANGLES</td> <td>±3</td> </tr> </table>		0 PLC	±	1 PLC	±0.3	2 PLC	±0.13	3 PLC	±0.013	4 PLC	±0.000J	ANGLES	±3	PRODUCT SPEC 108-106077	SIZE A3	CAGE CODE -
0 PLC	±															
1 PLC	±0.3															
2 PLC	±0.13															
3 PLC	±0.013															
4 PLC	±0.000J															
ANGLES	±3															
MATERIAL -		FINISH -	APPLICATION SPEC 114-106077	DRAWING NO C-1971793												
		WEIGHT -	RESTRICTED TO -													
CUSTOMER DRAWING			SCALE 5:1	SHEET 2 OF 3												
			REV G1													

THIS DRAWING IS UNPUBLISHED.

RELEASED FOR PUBLICATION

20

© COPYRIGHT 20 BY -

ALL RIGHTS RESERVED.

LOC -

DIST -

REVISIONS

P	LTR	DESCRIPTION	DATE	DWN	APVD
-	-	SEE SHEET 1	-	-	-

KEY A

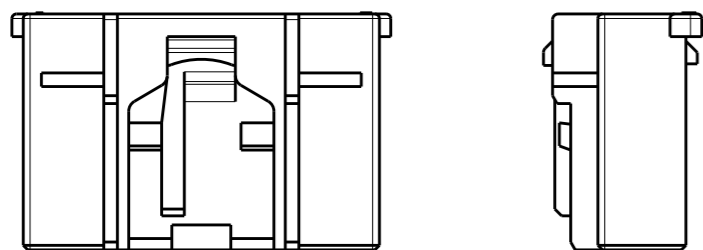

KEY B

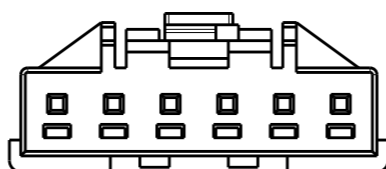
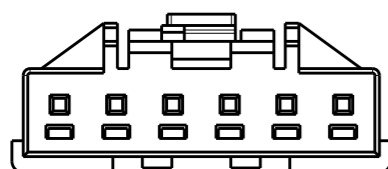
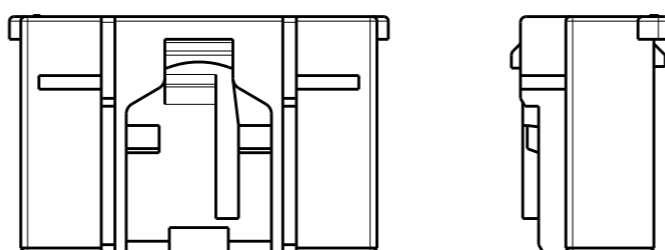

FOR 6-1971793-6 NO KEY

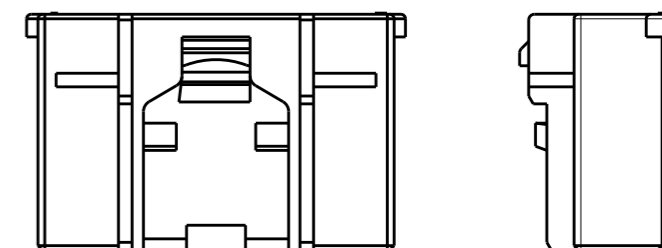

KEY C

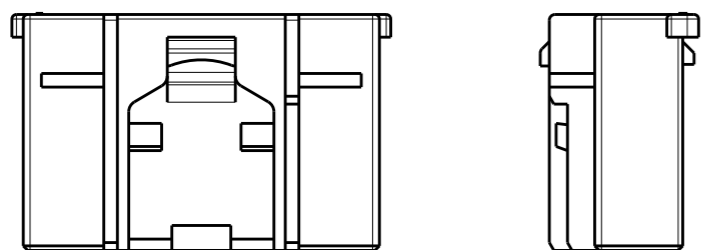

KEY D

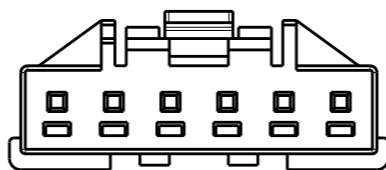
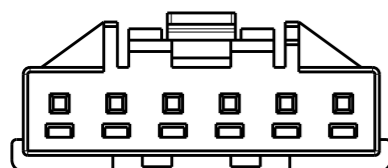
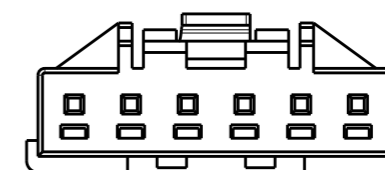
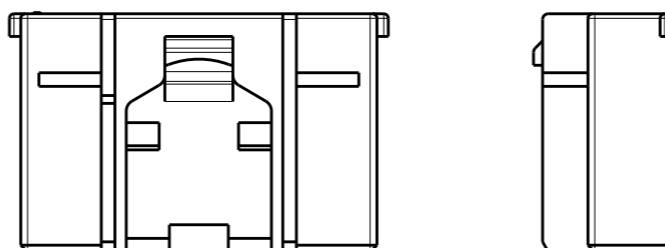

KEY TYPE 6-1971793-1 AS SHOWN

THIS DRAWING IS A CONTROLLED DOCUMENT.

DIMENSIONS:
mm

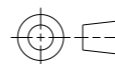

TOLERANCES UNLESS OTHERWISE SPECIFIED

- 0 PLC ±0.3
- 1 PLC ±0.3
- 2 PLC ±0.13
- 3 PLC ±0.013
- 4 PLC ±0.0001
- ANGLES ±3

MATERIAL -

FINISH -

DWN 15MAY2015

ANNIE QIAN

CHK 15MAY2015

ANNIE QIAN

APVD 15MAY2015

DANIEL ZHANG

PRODUCT SPEC

108-106077

APPLICATION SPEC

114-106077

WEIGHT -

CUSTOMER DRAWING



TE Connectivity

NAME
NEXT GENERATION
GRACE INERTIA CONNECTOR 2.5
PLUG HOUSING

SIZE A3 CAGE CODE - DRAWING NO. ©-1971793 RESTRICTED TO -

SCALE 5:1 SHEET 3 OF 3 REV G1

Mouser Electronics

Authorized Distributor

Click to View Pricing, Inventory, Delivery & Lifecycle Information:

[TE Connectivity:](#)

[5-1971793-3](#)