

# High-performance Clock Generator Series

## Compact 1ch Clock Generators for Digital Cameras

**BU3071HFV, BU3072HFV, BU3073HFV, BU3076HFV, BU7322HFV, BU7325HFV**

No.09005EAT01

### ●Description

These Clock Generators incorporate compact package compared to oscillators, which provides the generation of high-frequency CCD, USB, VIDEO clocks necessary for digital still cameras and digital video cameras.

### ●Features

- 1) SEL pin allowing for the selection of frequencies
- 2) Selection of OE pin enabling Power-down function
- 3) Crystal-oscillator-level clock precision with high C/N characteristics and low jitter
- 4) Micro miniature HVSO6 Package incorporated
- 5) Single power supply of 3.3 V

### ●Applications

Digital Still Camera, Digital Video Camera, and others

### ●Lineup

Parameter	BU3071HFV	BU3072HFV	BU3073HFV	BU3076HFV	BU7322HFV	BU7325HFV
Supply voltage	3.0 V ~ 3.6V	3.0 V ~ 3.6V	3.0 V ~ 3.6V	2.85 V ~ 3.6V	2.85 V ~ 3.6V	2.85 V ~ 3.6V
Operating temperature range	-5°C ~ 70°C	-5°C ~ 70°C	-5°C ~ 70°C	-5°C ~ 75°C	-5°C ~ 75°C	-30°C ~ 85°C
Reference input clock	28.6363MHz	48.0000MHz	48.0000MHz	27.0000MHz	27.0000MHz	27.0000MHz
Output clock	54.0000MHz	27.0000MHz	24.3750MHz	54.0000MHz	49.5000MHz	48.0000MHz
	-	36.0000MHz	24.5454MHz	67.5000MHz	36.0000MHz	78.0000MHz
Power-down function	Provided	Provided	Provided	Provided	Provided	Provided
Operating current (Typ.)	10mA	11mA	11mA	12mA	10mA	12mA
Package	HVSO6	HVSO6	HVSO6	HVSO6	HVSO6	HVSO6

### ●Absolute Maximum Ratings(Ta=25°C)

Parameter	Symbol	Ratings	Unit
Supply voltage	VDD	-0.3 ~ 4.0	V
Input voltage	VIN	-0.3 ~ VDD+0.3	V
Storage temperature range	Tstg	-30 ~ 125	°C
Power dissipation	Pd	410	mW

\*1 Operating is not guaranteed.

\*2 In the case of exceeding Ta = 25°C, 4.1mW should be reduced per 1°C.

\*3 The radiation-resistance design is not carried out.

\*4 Power dissipation is measured when the IC is mounted to the printed circuit board.

### ●Recommended Operating Range

Parameter	Symbol	Limits	Unit
Supply voltage	VDD	3.0 ~ 3.6	V
Input H voltage	VINH	0.8VDD ~ VDD	V
Input L voltage	VINL	0.0 ~ 0.2VDD	V
Operating temperature	Topr	-5 ~ 70	°C
Output load	CL	15(MAX)	pF

### ●Electrical Characteristics

BU3071HFV (Ta=25°C, VDD=3.3V, Crystal frequency=28.6363MHz, unless otherwise specified.)

Parameter	Symbol	Limits			Unit	Conditions
		Min.	Typ.	Max.		
Output H voltage	VOH	2.8	-	-	V	IOH=-4.0mA
Output L voltage	VOL	-	-	0.5	V	IOL=4.0mA
Consumption current 1	IDD1	-	10	15	mA	OE=H, at no load
Consumption current 2	IDD2	-	1	1.3	mA	OE=L
Output frequency		-	54.0000	-	MHz	IN*264/35/4
The following parameters represent design guaranteed performance.						
Duty	Duty	45	50	55	%	Measured at a voltage of 1/2 of VDD
Period-Jitter 1σ	PJsSD	-	50	-	psec	※1
Period-Jitter MIN-MAX	PJsABS	-	300	-	psec	※2
Rise time	tr	-	2.5	-	nsec	Period of transition time required for the output to reach 80% from 20% of VDD. Provided with 15pF output load.
Fall time	tf	-	2.5	-	nsec	Period of transition time required for the output to reach 20% from 80% of VDD. Provided with 15pF output load.
Output Lock time	tLOCK	-	-	1	msec	※3

Note) The output frequency is determined by the arithmetic (frequency division) expression of a frequency input to IN.  
If the input frequency is set to 28.6363MHz, the output frequency will be as listed above.

BU3072HFV (Ta=25°C, VDD=3.3V, Crystal frequency=48.0000MHz, unless otherwise specified.)

Parameter	Symbol	Limits			Unit	Conditions
		Min.	Typ.	Max.		
Output H voltage	VOH	2.8	-	-	V	IOH=-4.0mA
Output L voltage	VOL	-	-	0.5	V	IOL=4.0mA
Consumption current 1	IDD1	-	11	16	mA	PD=H, at no load
Consumption current 2	IDD2	-	-	5	μA	PD=L
Output frequency	CLK_27	-	27.0000	-	MHz	SEL=L, IN*18/8/4
	CLK_36	-	36.0000	-	MHz	SEL=H, IN*24/8/4
The following parameters represent design guaranteed performance.						
Duty	Duty	45	50	55	%	Measured at a voltage of 1/2 of VDD
Period-Jitter 1σ	PJsSD	-	35	-	psec	※1
Long-Term-Jitter MIN-MAX	LTJsABS	-	0.9	1.5	nsec	MIN-MAX of long-term jitter (100 μsec from trigger)
Rise time	tr	-	2.5	-	nsec	Period of transition time required for the output to reach 80% from 20% of VDD. Provided with 15pF output load.
Fall time	tf	-	2.5	-	nsec	Period of transition time required for the output to reach 20% from 80% of VDD. Provided with 15pF output load.
Output Lock time	tLOCK	-	-	1	msec	※3

Note) The output frequency is determined by the arithmetic (frequency division) expression of a frequency input to IN.  
If the input frequency is set to 48.0000MHz, the output frequency will be as listed above.

BU3073HFV(Ta=25°C, VDD=3.3V, Crystal frequency=48.0000MHz, unless otherwise specified.)

Parameter	Symbol	Limits			Unit	Conditions
		Min.	Typ.	Max.		
Output H voltage	VOH	2.8	-	-	V	IOH=-4.0mA
Output L voltage	VOL	-	-	0.5	V	IOL=4.0mA
Consumption current 1	IDD1	-	11	16	mA	PD=H, at no load
Consumption current 2	IDD2	-	-	5	mA	PD=L
Output frequency	CLK_375	-	24.3750	-	MHz	SEL=L, IN*65/16/8
	CLK_545	-	24.5454	-	MHz	SEL=H, IN*45/11/8
The following parameters represent design guaranteed performance.						
Duty	Duty	45	50	55	%	Measured at a voltage of 1/2 of VDD
Period-Jitter 1σ	PJsSD	-	45	-	psec	※1
Long-Term-Jitter MIN-MAX	LTJsABS	-	0.9	1.5	nsec	MIN-MAX of long-term jitter (100 μsec from trigger)
Rise time	tr	-	2.5	-	nsec	Period of transition time required for the output to reach 80% from 20% of VDD. Provided with 15pF output load.
Fall time	tf	-	2.5	-	nsec	Period of transition time required for the output to reach 20% from 80% of VDD. Provided with 15pF output load.
Output Lock time	tLOCK	-	-	1	msec	※3

Note) The output frequency is determined by the arithmetic (frequency division) expression of a frequency input to IN.  
If the input frequency is set to 48.0000MHz, the output frequency will be as listed above.

BU3076HFV(Ta=25°C, VDD=3.3V, Crystal frequency=27.0000MHz, unless otherwise specified.)

Parameter	Symbol	Limits			Unit	Conditions
		Min.	Typ.	Max.		
Output H voltage	VOH	2.8	-	-	V	IOH=-4.0mA
Output L voltage	VOL	-	-	0.5	V	IOL=4.0mA
Pull-down resistance	Rpd	25	50	100	KΩ	Pull-down resistance on input pin
Consumption current 1	IDD1	-	10	15	mA	54MHz output, at no load
Consumption current 2	IDD2	-	12	18	mA	67.5MHz output, at no load
Standby current	IDDst	-	-	1	μA	OE=L
Output frequency	CLK_54	-	54.0000	-	MHz	SEL=L, IN*48/6/4
	CLK_67.5	-	67.5000	-	MHz	SEL=H, IN*60/6/4
The following parameters represent design guaranteed performance.						
Duty	Duty	45	50	55	%	Measured at a voltage of 1/2 of VDD
Period-Jitter 1σ	PJsSD	-	50	-	psec	※1
Period-Jitter MIN-MAX	PJsABS	-	300	-	psec	※2
Rise time	tr	-	1.5	-	nsec	Period of transition time required for the output to reach 80% from 20% of VDD. Provided with 15pF output load.
Fall time	tf	-	1.5	-	nsec	Period of transition time required for the output to reach 20% from 80% of VDD. Provided with 15pF output load.
Output Lock time	tLOCK	-	-	200	μsec	※3

Note) The output frequency is determined by the arithmetic (frequency division) expression of a frequency input to IN.  
If the input frequency is set to 27.0000MHz, the output frequency will be as listed above.

BU7322HFV (Ta=25°C, VDD=3.3V, Crystal frequency=27.0000MHz, unless otherwise specified.)

Parameter	Symbol	Limits			Unit	Conditions
		Min.	Typ.	Max.		
Output H voltage	VOH	2.8	-	-	V	IOH=-4.0mA
Output L voltage	VOL	-	-	0.5	V	IOL=4.0mA
Pull-down resistance	Rpd	25	50	100	kΩ	Pull-down resistance on input pin
Consumption current 1	IDD	-	10	13.5	mA	49.5MHz output, at no load
Consumption current 2	IDD2	-	9.5	13.0	mA	36.0MHz output, at no load
Standby current	IDDst	-	-	1	μA	OE=L
Output frequency	CLK_49.5	-	49.5000	-	MHz	SEL=L, IN*66/6/6
	CLK_36	-	36.0000	-	MHz	SEL=H, IN*64/6/8
The following parameters represent design guaranteed performance.						
Duty	Duty	45	50	55	%	Measured at a voltage of 1/2 of VDD
Period-Jitter 1σ	PJsSD	-	50	-	psec	※1
Period-Jitter MIN-MAX	PJsABS	-	300	-	psec	※2
Rise time	tr	-	2.5	-	nsec	Period of transition time required for the output to reach 80% from 20% of VDD. Provided with 15pF output load.
Fall time	tf	-	2.5	-	nsec	Period of transition time required for the output to reach 20% from 80% of VDD. Provided with 15pF output load.
Output Lock time	tLOCK	-	-	200	μsec	※3

Note) The output frequency is determined by the arithmetic (frequency division) expression of a frequency input to IN.  
If the input frequency is set to 27.0000MHz, the output frequency will be as listed above.

BU7325HFV (Ta=25°C, VDD=3.3V, Crystal frequency=27.0000MHz, unless otherwise specified.)

Parameter	Symbol	Limits			Unit	Conditions
		Min.	Typ.	Max.		
Output H voltage	VOH	2.8	-	-	V	IOH=-4.0mA
Output L voltage	VOL	-	-	0.5	V	IOL=4.0mA
Pull-down resistance	Rpd	25	50	100	kΩ	Pull-down resistance on input pin
Consumption current 1	IDD1	-	11	15	mA	OE=H, SEL=L, at no load
Consumption current 2	IDD2	-	12	16.5	mA	OE=H, SEL=H, at no load
Standby current	IDDst	-	-	1	μA	OE=L
Output frequency	CLK_48	-	48.0000	-	MHz	SEL=L, IN*96/9/6
	CLK_78	-	78.0000	-	MHz	SEL=H, IN*104/9/4
The following parameters represent design guaranteed performance.						
Duty	Duty	45	50	55	%	Measured at a voltage of 1/2 of VDD
Period-Jitter 1σ	PJsSD	-	50	-	psec	※1
Period-Jitter MIN-MAX	PJsABS	-	300	-	psec	※2
Rise time	tr	-	1.5	-	nsec	Period of transition time required for the output to reach 80% from 20% of VDD. Provided with 15pF output load.
Fall time	tf	-	1.5	-	nsec	Period of transition time required for the output to reach 20% from 80% of VDD. Provided with 15pF output load.
Output Lock time	tLOCK	-	-	200	μsec	※3

Note) The output frequency is determined by the arithmetic (frequency division) expression of a frequency input to IN.  
If the input frequency is set to 27.0000MHz, the output frequency will be as listed above.

Common to BU3071HFV, BU3072HFV, BU3073HFV, BU3076HFV, BU7322HFV, BU7325HFV

- ※1 Period-Jitter 1σ  
This parameter represents standard deviation (=1σ) on cycle distribution data at the time when the output clock cycles are sampled 1000 times consecutively with the TDS7104 Digital Phosphor Oscilloscope of Tektronix Japan, Ltd.
- ※2 Period-Jitter MIN-MAX  
This parameter represents a maximum distribution width on cycle distribution data at the time when the output clock cycles are sampled 1000 times consecutively with the TDS7104 Digital Phosphor Oscilloscope of Tektronix Japan, Ltd.
- ※3 Output Lock Time  
This parameter represents elapsed time after power supply turns ON to reach a voltage of 3.0 V, after the system is switched from Power-Down state to normal operation state, or after the output frequency is switched, until it is stabilized at a specified frequency, respectively.

●Reference data (BU3071HFV basic data)

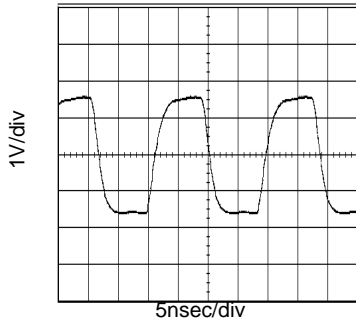

Fig.1 54MHz output waveform  
(VDD=3.3V, CL=15pF, Ta=25°C)

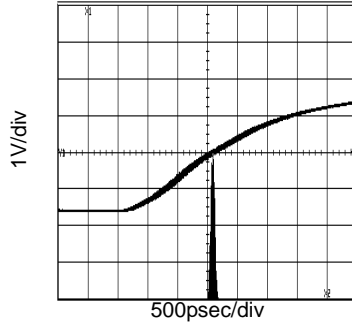

Fig.2 54MHz Period-Jitter  
(VDD=3.3V, CL=15pF, Ta=25°C)

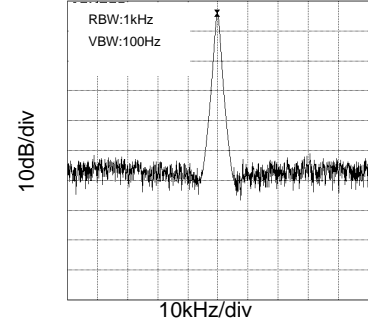

Fig.3 54MHz spectrum  
(VDD=3.3V, CL=15pF, Ta=25°C)

●Reference data (BU3072HFV basic data)

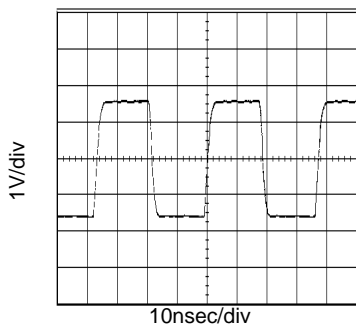

Fig.4 27MHz output waveform  
(VDD=3.3V, CL=15pF, Ta=25°C)

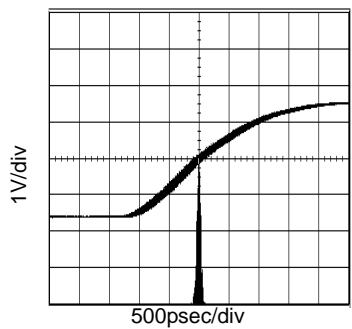

Fig.5 27MHz Period-Jitter  
(VDD=3.3V, CL=15pF, Ta=25°C)

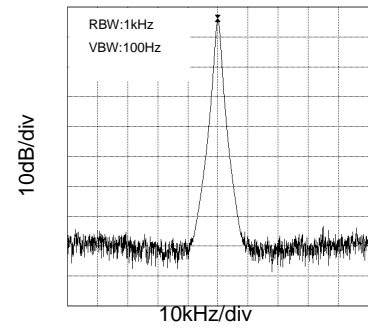

Fig.6 27MHz spectrum  
(VDD=3.3V, CL=15pF, Ta=25°C)

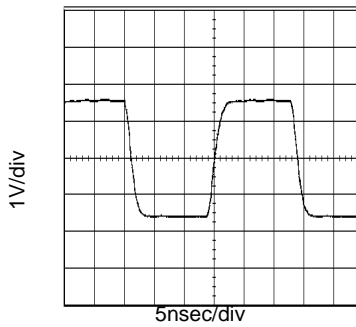

Fig.7 36MHz output waveform  
(VDD=3.3V, CL=15pF, Ta=25°C)

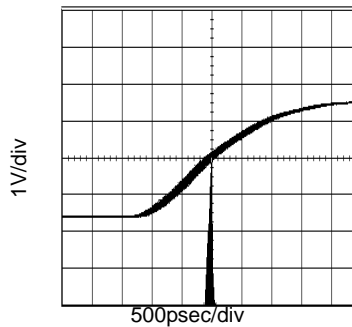

Fig.8 36MHz Period-Jitter  
(VDD=3.3V, CL=15pF, Ta=25°C)

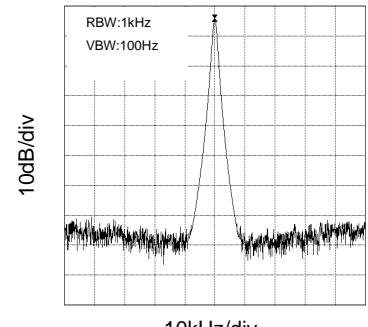

Fig.9 36MHz spectrum  
(VDD=3.3V, CL=15pF, Ta=25°C)

●Reference data (BU3073HFV basic data)

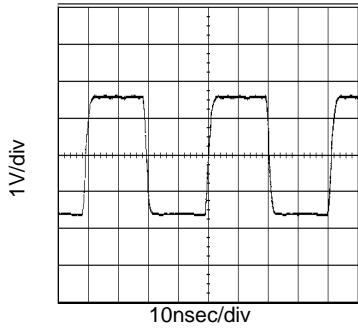

Fig.10 24.375MHz output waveform (VDD=3.3V, CL=15pF, Ta=25°C)

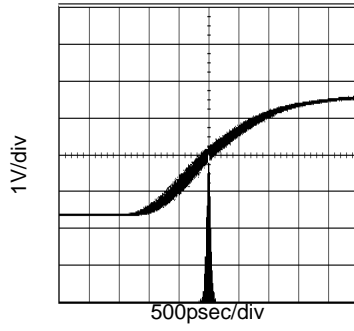

Fig.11 24.375MHz Period-Jitter (VDD=3.3V, CL=15pF, Ta=25°C)

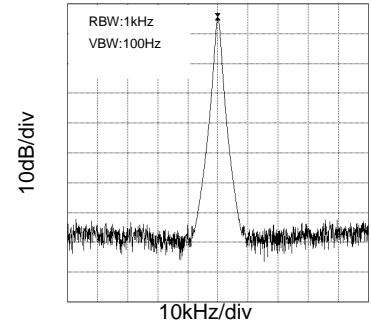

Fig.12 24.375MHz spectrum (VDD=3.3V, CL=15pF, Ta=25°C)

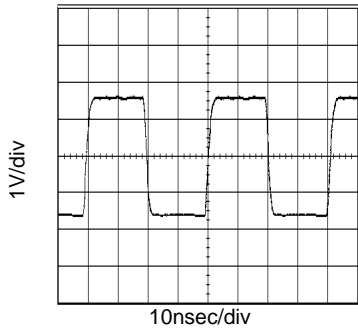

Fig.13 24.5454MHz output waveform (VDD=3.3V, CL=15pF, Ta=25°C)

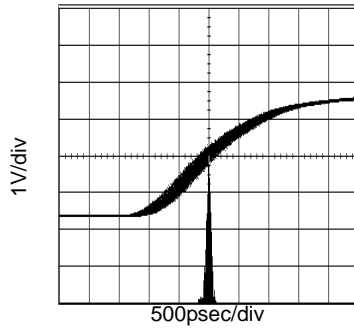

Fig.14 24.5454MHz Period-Jitter (VDD=3.3V, CL=15pF, Ta=25°C)

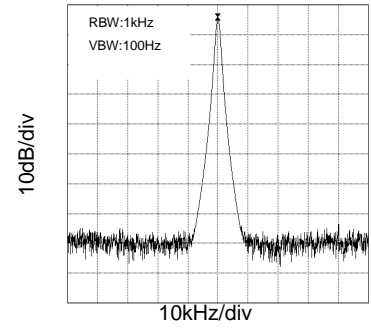

Fig.15 24.5454MHz spectrum (VDD=3.3V, CL=15pF, Ta=25°C)

●Reference data (BU3076HFV basic data)

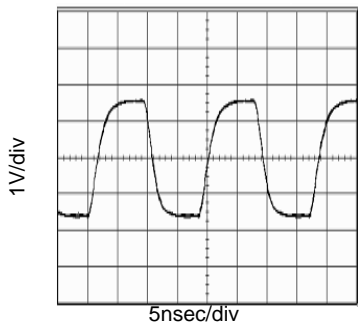

Fig.16 54MHz output waveform (VDD=3.3V, CL=15pF, Ta=25°C)

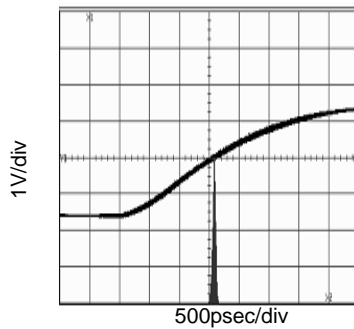

Fig.17 54MHz Period-Jitter (VDD=3.3V, CL=15pF, Ta=25°C)

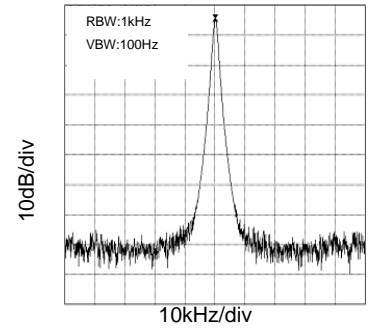

Fig.18 54MHz spectrum (VDD=3.3V, CL=15pF, Ta=25°C)

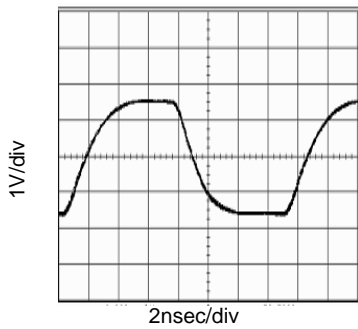

Fig.19 67.5MHz output waveform (VDD=3.3V, CL=15pF, Ta=25°C)

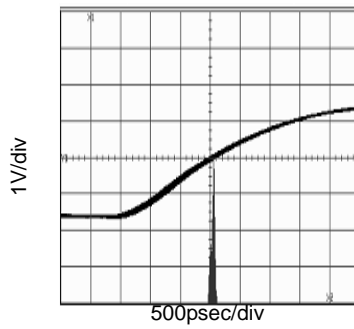

Fig.20 67.5MHz Period-Jitter (VDD=3.3V, CL=15pF, Ta=25°C)

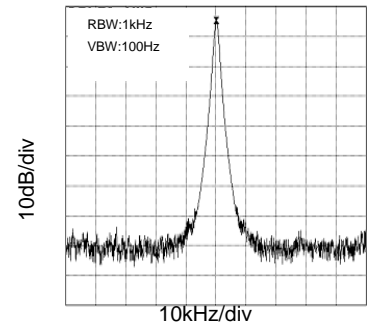

Fig.21 67.5MHz spectrum (VDD=3.3V, CL=15pF, Ta=25°C)

●Reference data (BU7322HFV basic data)

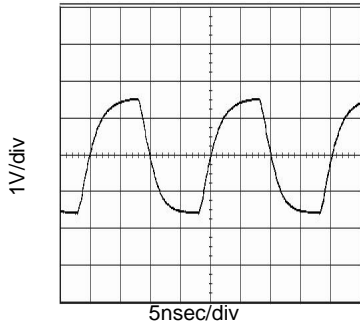

Fig.22 49.5MHz output waveform (VDD=3.3V,CL=15pF,Ta=25°C)

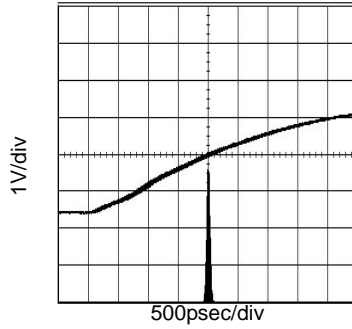

Fig.23 49.5MHz Period-Jitter (VDD=3.3V,CL=15pF,Ta=25°C)

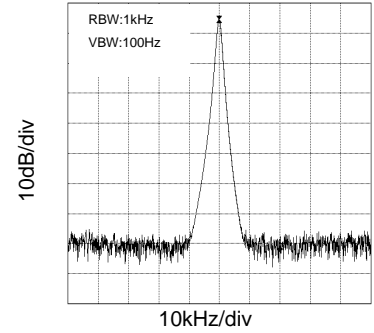

Fig.24 49.5MHz spectrum (VDD=3.3V,CL=15pF,Ta=25°C)

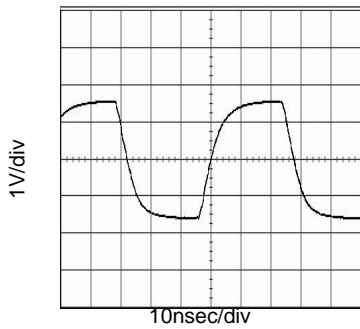

Fig.25 36MHz output waveform (VDD=3.3V,CL=15pF,Ta=25°C)

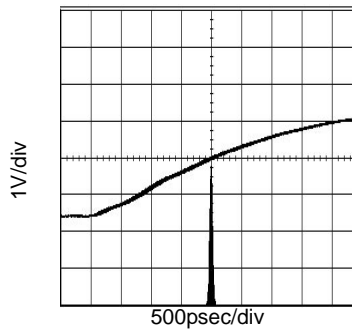

Fig.26 36MHz Period-Jitter (VDD=3.3V,CL=15pF,Ta=25°C)

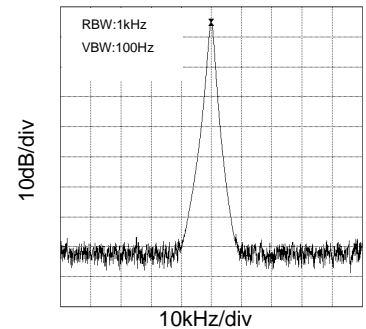

Fig.27 36MHz spectrum (VDD=3.3V,CL=15pF,Ta=25°C)

●Reference data (BU7325HFV basic data)

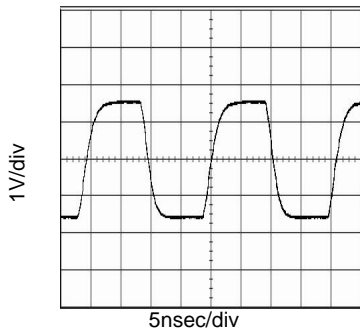

Fig.28 48MHz output waveform (VDD=3.3V,CL=15pF,Ta=25°C)

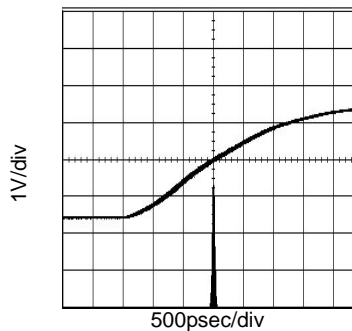

Fig.29 48MHz Period-Jitter (VDD=3.3V,CL=15pF,Ta=25°C)

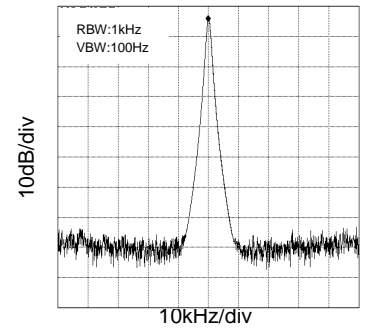

Fig.30 48MHz spectrum (VDD=3.3V,CL=15pF,Ta=25°C)

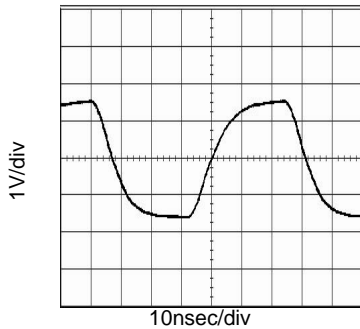

Fig.31 78MHz output waveform (VDD=3.3V,CL=15pF,Ta=25°C)

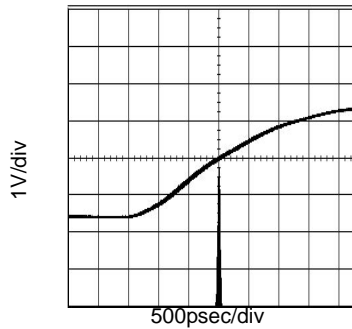

Fig.32 78MHz Period-Jitter (VDD=3.3V,CL=15pF,Ta=25°C)

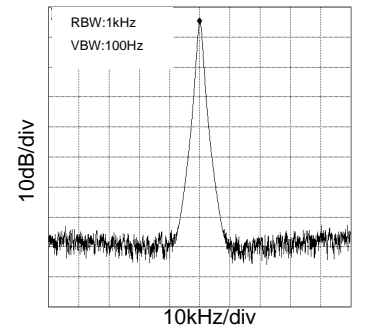

Fig.33 78MHz spectrum (VDD=3.3V,CL=15pF,Ta=25°C)

●Reference data (BU3071HFV Temperature and Supply voltage variations data)

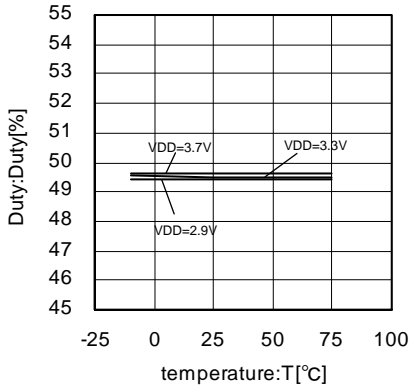

Fig.34 54MHz  
Duty temperature characteristics

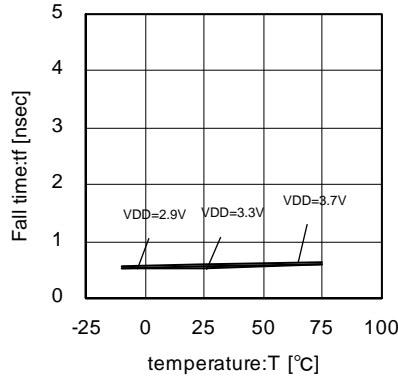

Fig.35 54MHz  
Rise-time temperature characteristics

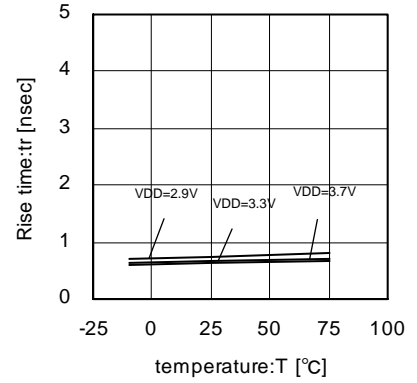

Fig.36 54MHz  
Fall-time temperature characteristics

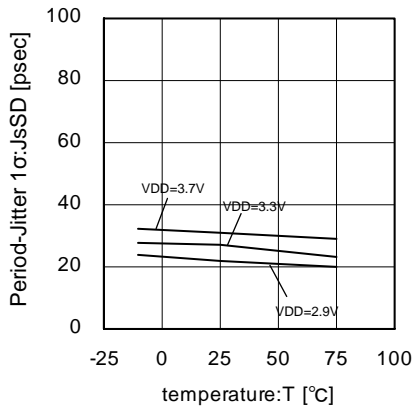

Fig.37 54MHz Period-Jitter 1σ  
temperature characteristics

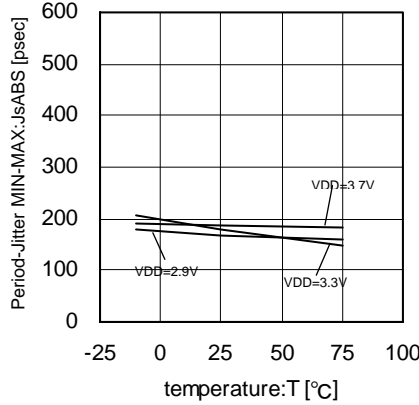

Fig.38 54MHz Jitter-Min Max  
temperature characteristics

●Reference data (BU3072HFV Temperature and Supply voltage variations data)

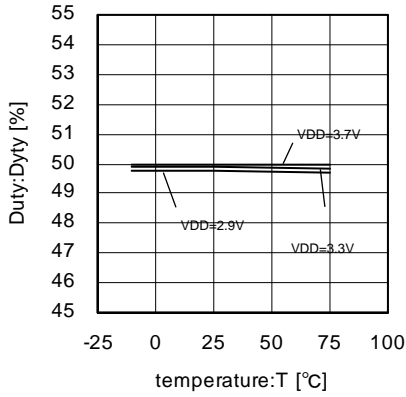

Fig.39 27MHz Duty temperature characteristics

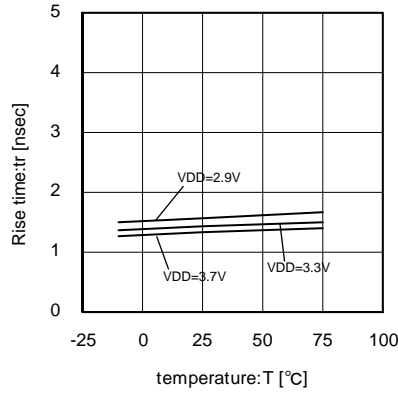

Fig.40 27MHz Rise-time temperature characteristics

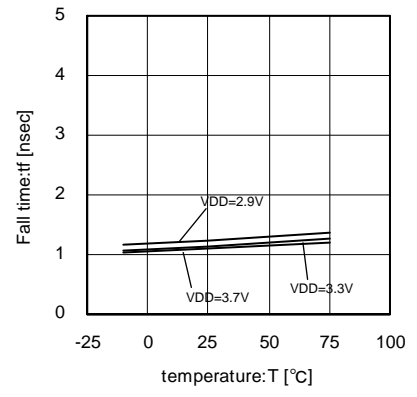

Fig.41 27MHz Fall-time temperature characteristics

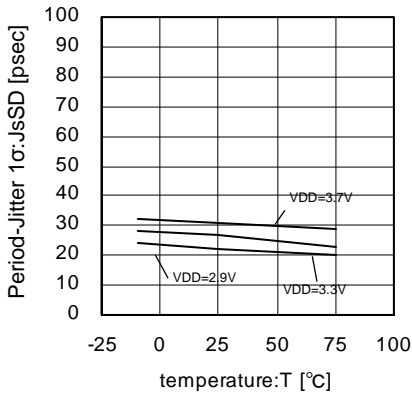

Fig.42 27MHz Period-Jitter 1σ temperature characteristics

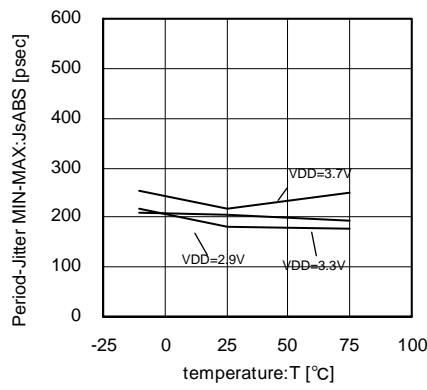

Fig.43 27MHz Jitter-MinMax temperature characteristics

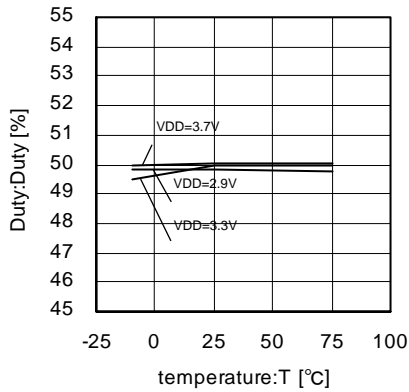

Fig.44 36MHz Duty temperature characteristic

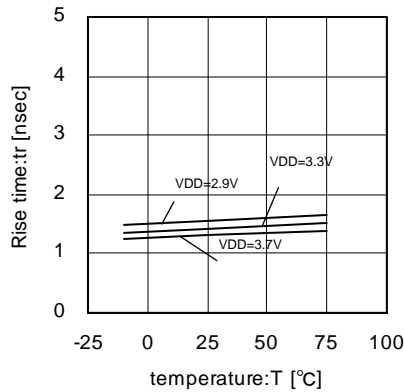

Fig.45 36MHz Rise-time temperature characteristics

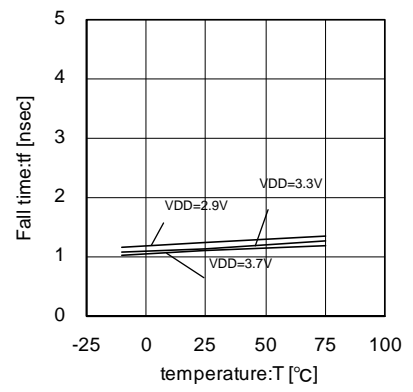

Fig.46 36MHz Fall-time temperature characteristics

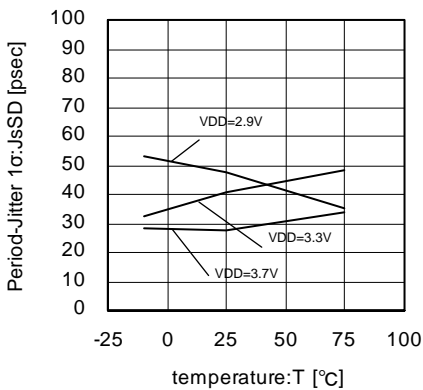

Fig.47 36MHz Period-Jitter 1σ temperature characteristic s

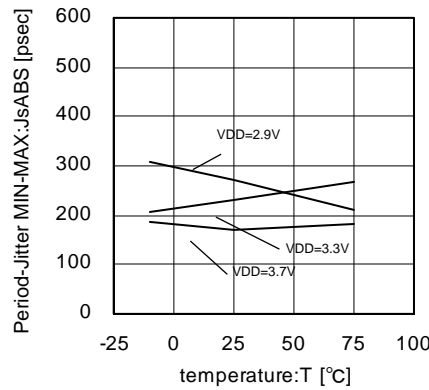

Fig.48 36MHz Jitter-Min Max temperature characteristics

●Reference data (BU3073HFV Temperature and Supply voltage variations data)

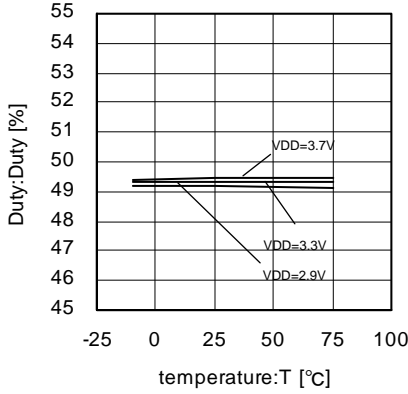

Fig.49 24.375MHz Duty temperature characteristics

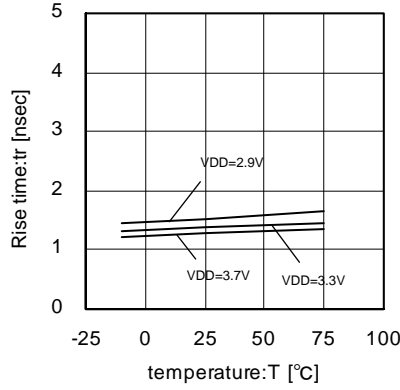

Fig.50 24.375MHz Rise-time temperature characteristics

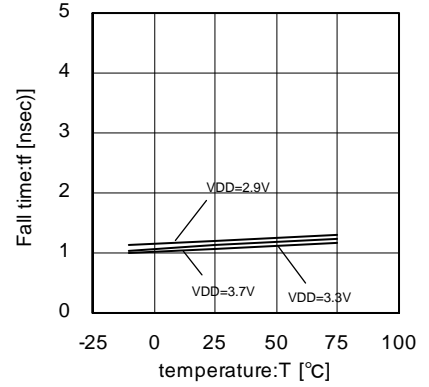

Fig.51 24.375MHz Fall-time temperature characteristics

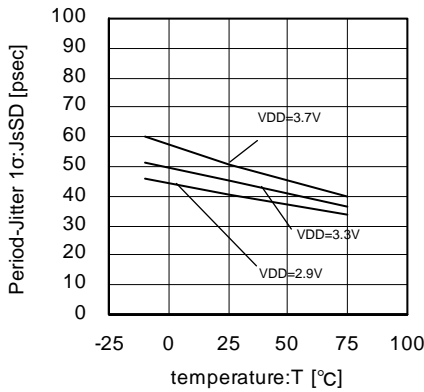

Fig.52 24.375MHz Period-Jitter 1σ temperature characteristics

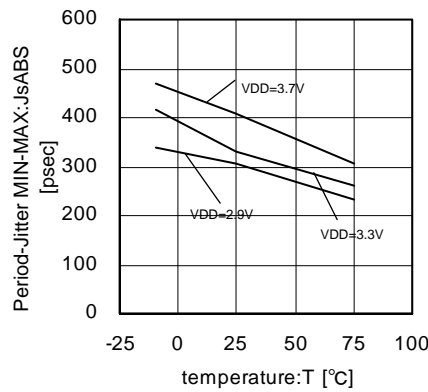

Fig.53 24.375MHz Jitter-Min Max temperature characteristics

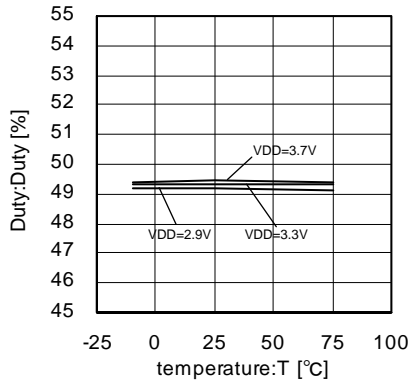

Fig.54 24.5454MHz Duty temperature characteristics

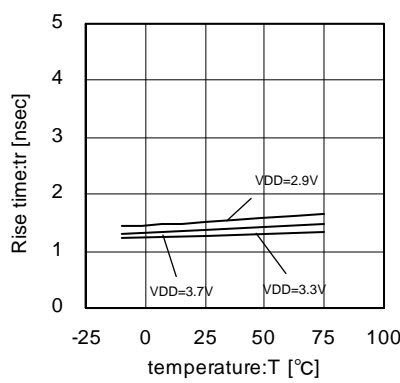

Fig.55 24.5454MHz Rise-time temperature characteristics

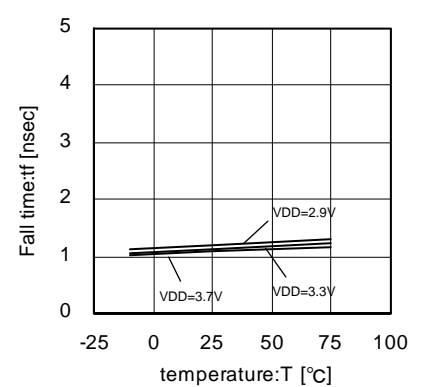

Fig.56 24.5454MHz Fall-time temperature characteristics

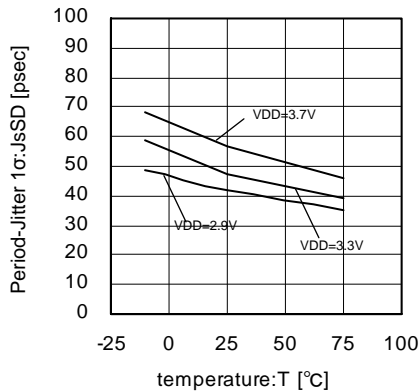

Fig.57 24.5454MHz Period-Jitter 1σ temperature characteristics

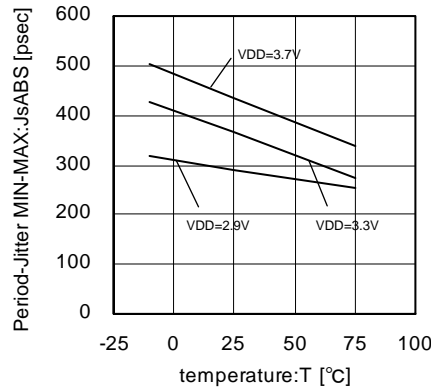

Fig.58 24.5454MHz Jitter-MinMax temperature characteristics

●Reference data (BU3076HFV Temperature and Supply voltage variations data)

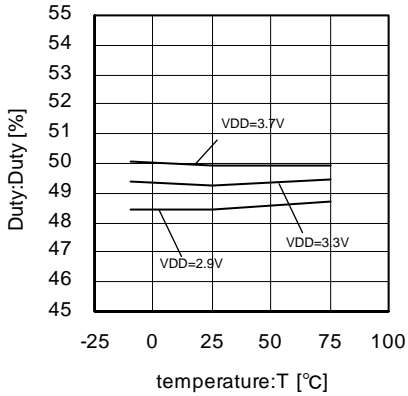

Fig.59 54MHz Duty temperature characteristics

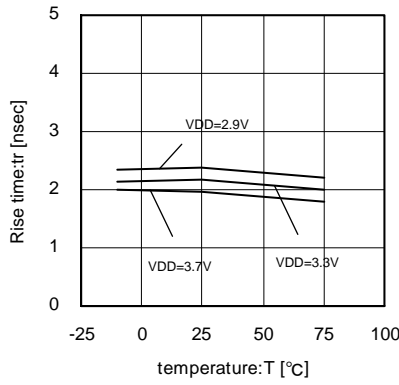

Fig.60 54MHz Rise-time temperature characteristics

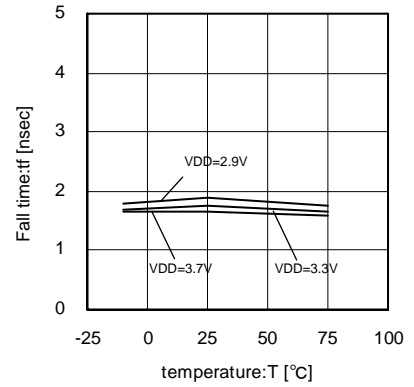

Fig.61 54MHz Fall-time temperature characteristics

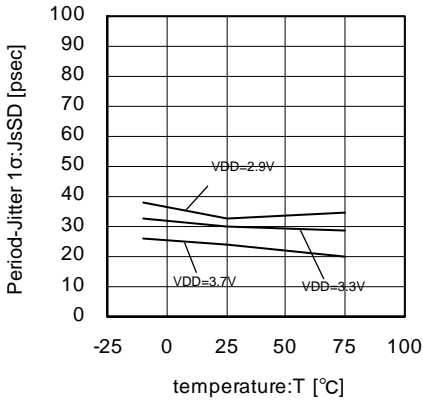

Fig.62 54MHz Period-Jitter 1σ temperature characteristics

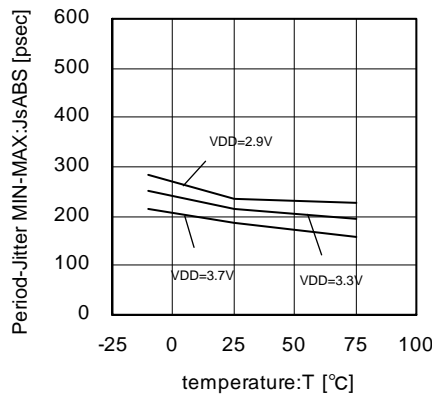

Fig.63 54MHz Jitter-Min Max temperature characteristics

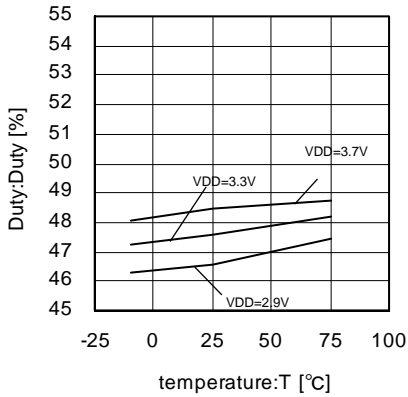

Fig.64 67.5MHz Duty temperature characteristics

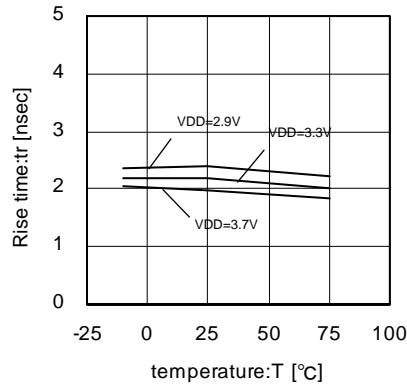

Fig.65 67.5MHz Rise-time temperature characteristics

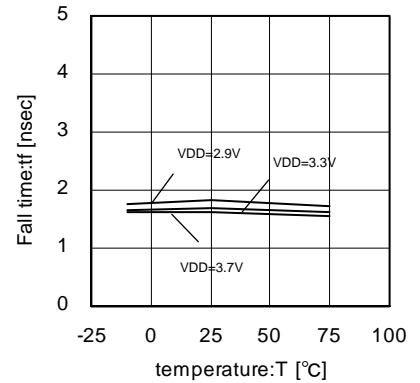

Fig.66 67.5MHz Fall-time temperature characteristics

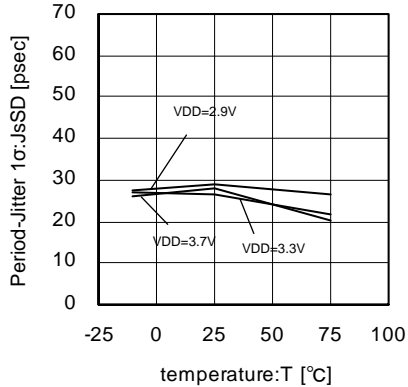

Fig.67 67.5MHz Period-Jitter 1σ temperature characteristics

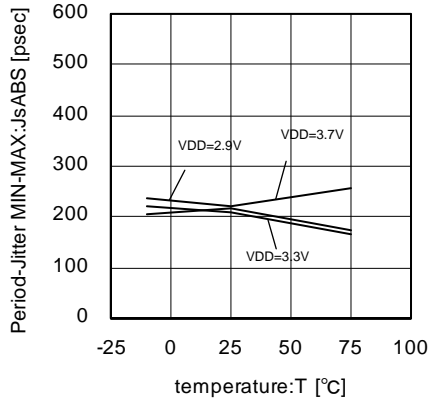

Fig.68 67.5MHz Jitter-MinMax temperature characteristics

●Reference data (BU7322HFV Temperature and Supply voltage variations data)

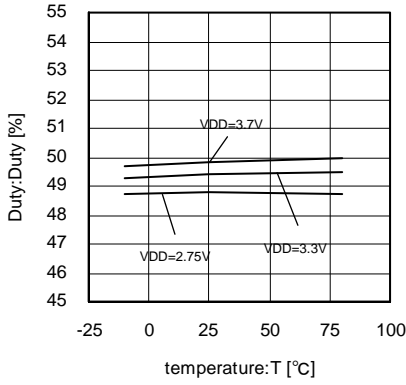

Fig.69 49.5MHz Duty temperature characteristics

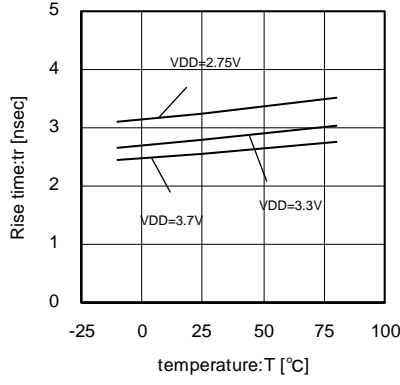

Fig.70 49.5MHz Rise-time temperature characteristics

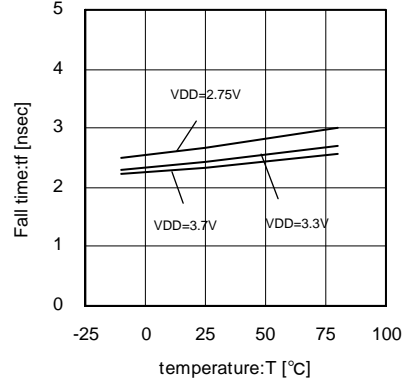

Fig.71 49.5MHz Fall-time temperature characteristics

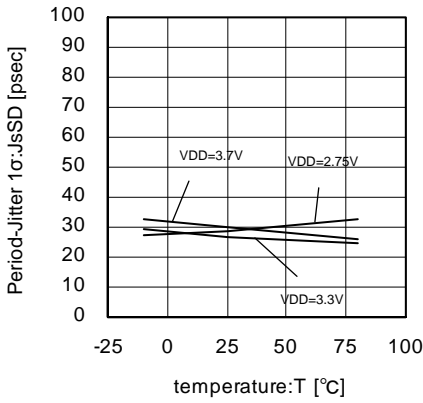

Fig.72 49.5MHz Period-Jitter 1σ temperature characteristics

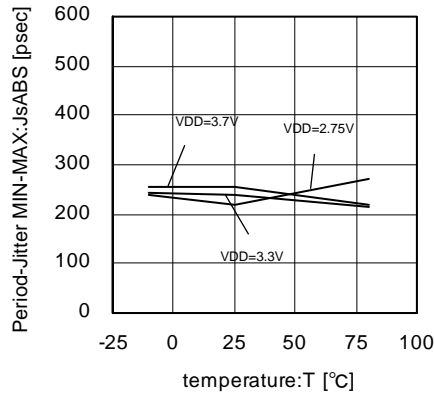

Fig.73 49.5MHz Jitter-Min Max temperature characteristics

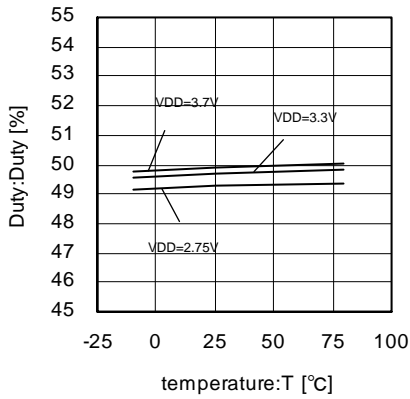

Fig.74 36MHz Duty temperature characteristics

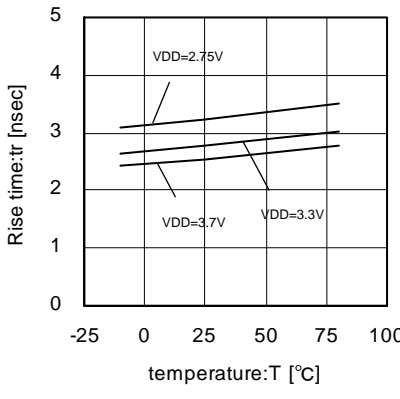

Fig.75 36MHz Rise-time temperature characteristics

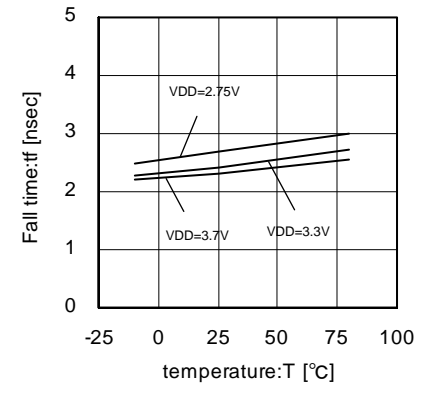

Fig.76 36MHz Fall-time temperature characteristics

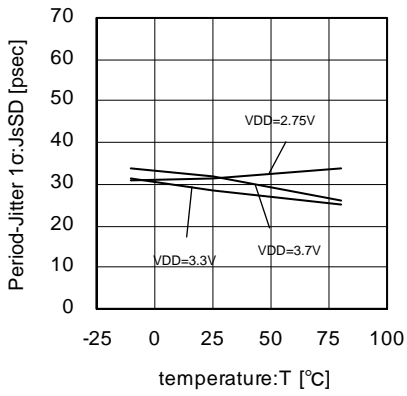

Fig.77 36MHz Period-Jitter 1σ temperature characteristics

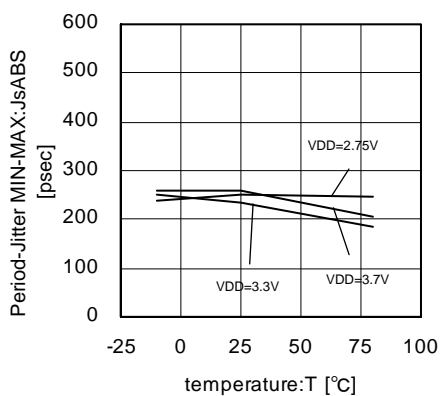

Fig.78 36MHz Jitter-MinMax temperature characteristics

●Reference data (BU7325HFV Temperature and Supply voltage variations data)

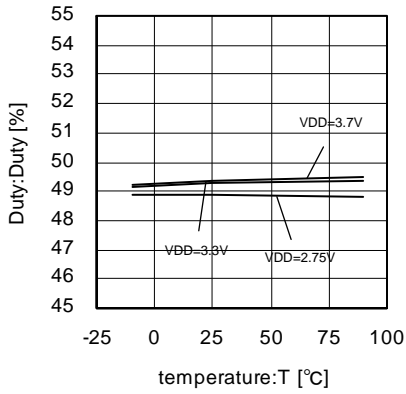

Fig.79 48MHz

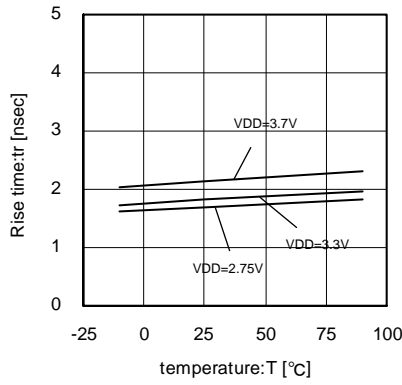

Fig.80 48MHz

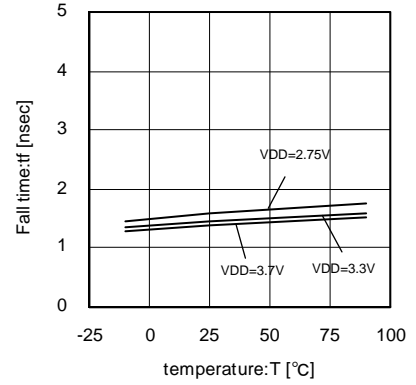

Fig.81 48MHz

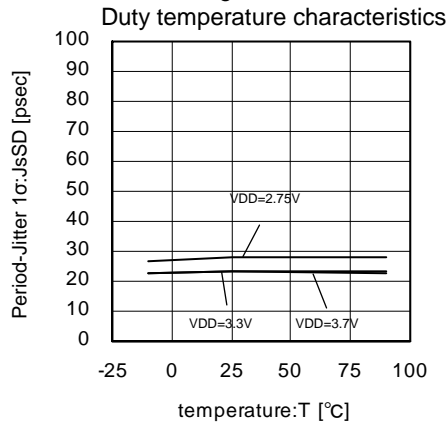

Fig.82 48MHz Period-Jitter 1σ temperature characteristics

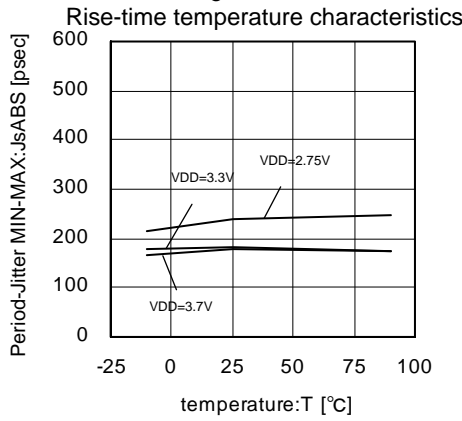

Fig.83 48MHz Jitter-Min Max temperature characteristics

Fall-time temperature characteristics

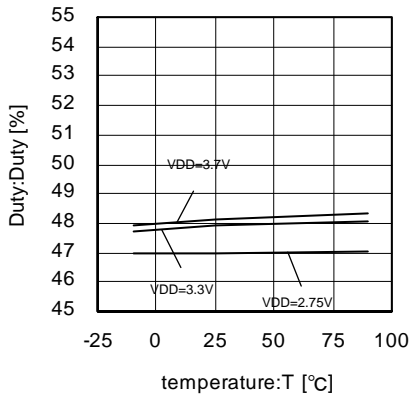

Fig.84 78MHz Duty temperature characteristics

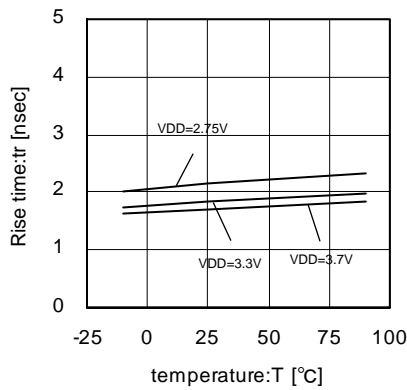

Fig.85 78MHz Rise-time temperature characteristics

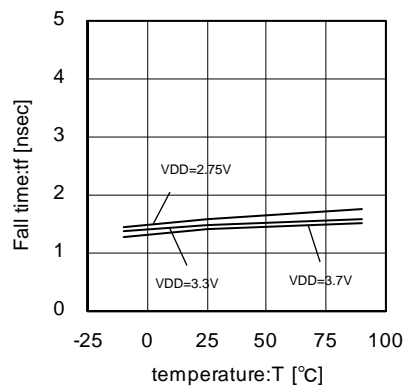

Fig.86 78MHz Fall-time temperature characteristics

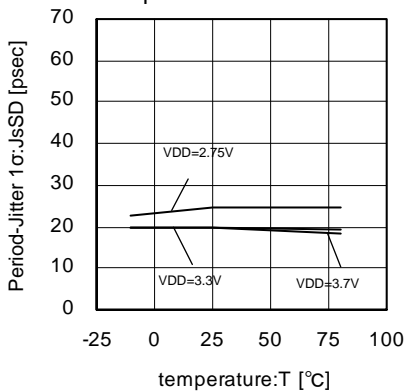

Fig.87 78MHz Period-Jitter 1σ temperature characteristics

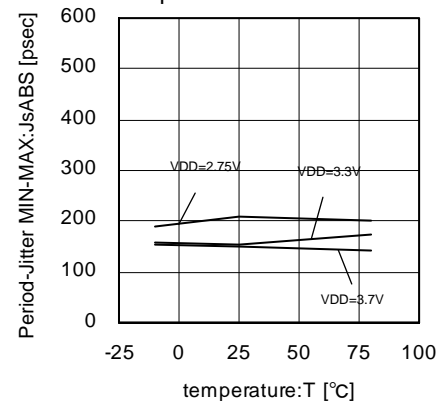

Fig.88 78MHz Jitter-MinMax temperature characteristic

●Block diagram, pin assignment/functions  
(BU3071HFV)

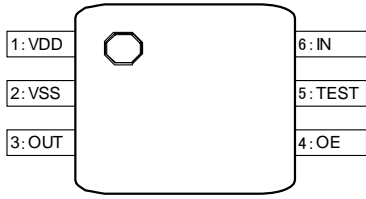

Fig.89

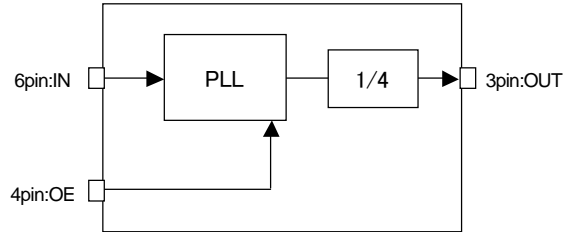

Fig.90

PIN NO.	PIN name	Function
1	VDD	Power supply
2	VSS	GND
3	OUT	Clock output terminal
4	OE	Output enable (L: disable, H: enable), equipped with Pull-down function, output fixed to L at disable
5	TEST	TEST pin, equipped with Pull-down function
6	IN	Clock input pin (28.6363 MHz input)

(BU3072HFV)

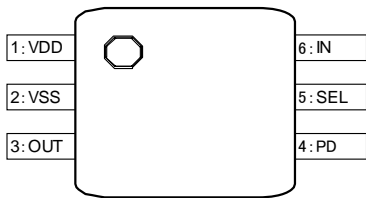

Fig.91

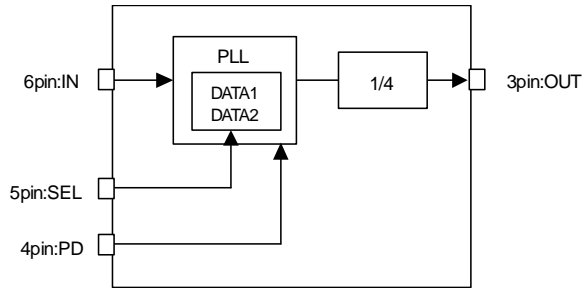

Fig.92

PIN NO.	PIN name	Function
1	VDD	Power supply
2	VSS	GND
3	OUT	Clock output terminal (L:27.0000MHz, H:36.0000MHz)
4	PD	Power-down (L: Hi-Z, H: enable), equipped with Pull-down function, output set to Hi-Z at disable
5	SEL	Output selection (L: 27.0000 MHz, H: 36.0000 MHz)
6	IN	Clock input pin (48.0000 MHz input)

(BU3073HFV)

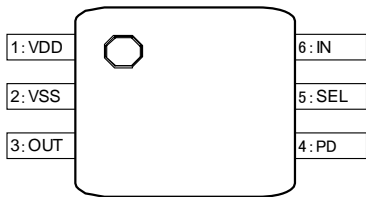

Fig.93

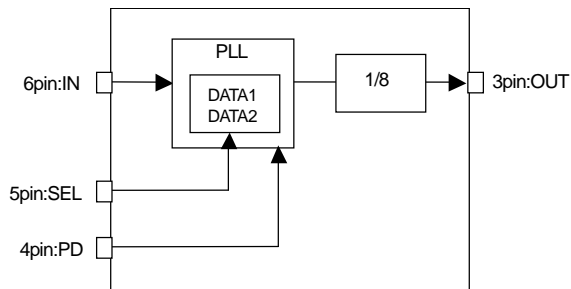

Fig.94

PIN NO.	PIN name	Function
1	VDD	Power supply
2	VSS	GND
3	OUT	Clock output terminal (L:24.3750MHz, H:24.5454MHz)
4	PD	Power-down (L: disable, H: enable), equipped with Pull-down function, output set to L at disable
5	SEL	Output selection (L:24.3750MHz, H:24.5454MHz)
6	IN	Clock input pin (48.0000MHz input)

(BU3076HFV)

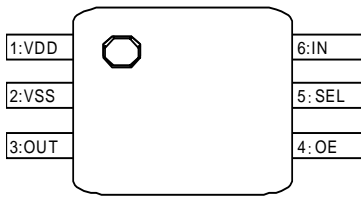

Fig.95

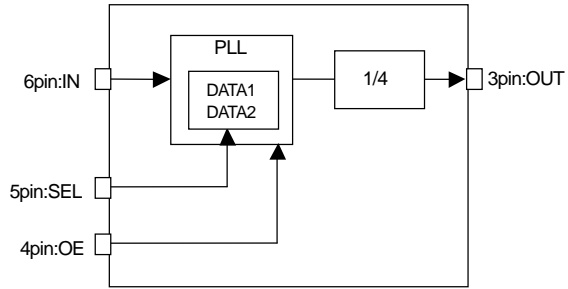

Fig.96

PIN NO.	PIN name	Function
1	VDD	Power supply
2	VSS	GND
3	OUT	Clock output terminal (L:54.0000MHz, H:67.5000MHz)
4	OE	Power-down (L: disable, H: enable), equipped with Pull-down function, output set to L at disable
5	SEL	Output selection (L:54.0000MHz, H:67.5000MHz)
6	IN	Clock input pin (27.0000MHz input)

(BU7322HFV)

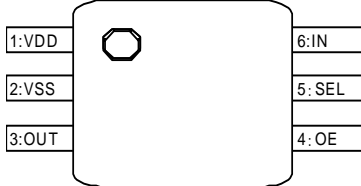

Fig.97

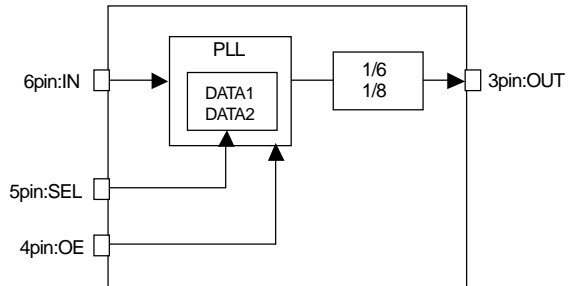

Fig.98

PIN NO.	PIN name	Function
1	VDD	Power supply
2	VSS	GND
3	OUT	Clock output terminal (L:49.5000MHz, H:36.0000MHz)
4	OE	Power-down (L:disable ,H:enable) equipped with Pull-down function, disable output set to L at disable
5	SEL	Output selection (L:49.5000MHz, H:36.0000MHz) equipped with Pull-down function
6	IN	Clock input pin (27.0000MHz input)

(BU7325HFV)

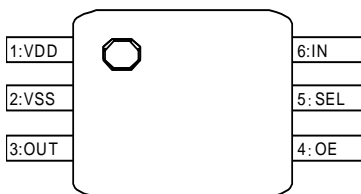

Fig.99

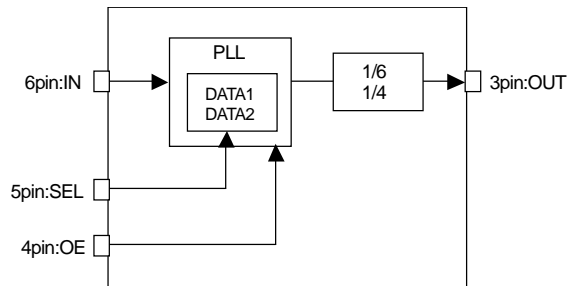

Fig.100

PIN NO.	PIN name	Function
1	VDD	Power supply
2	VSS	GND
3	OUT	Clock output terminal (L:48.0000MHz, H:78.0000MHz)
4	OE	Power-down (L:disable ,H:enable) equipped with Pull-down function, disable output set to L at disable
5	SEL	Output selection (L:48.0000MHz, H:78.0000MHz)
6	IN	Clock input pin (27.0000MHz input)

● Application circuit example

(BU3071HFV)

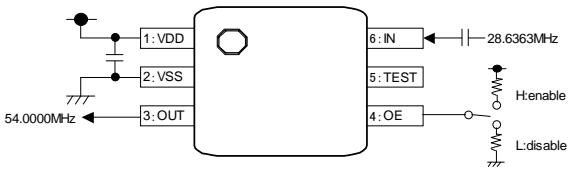

Fig.101

(BU3072HFV)

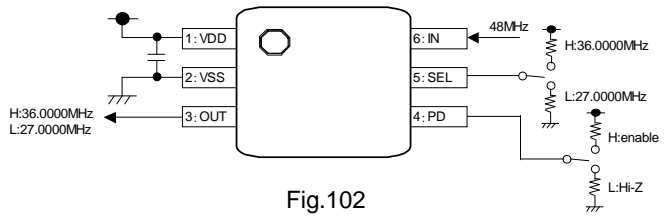

Fig.102

(BU3073HFV)

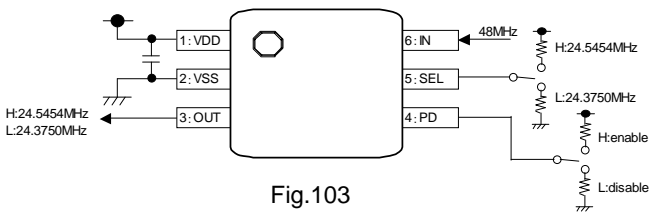

Fig.103

(BU3076HFV)

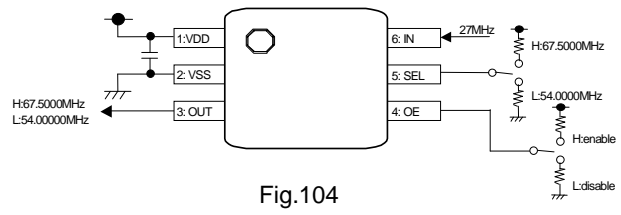

Fig.104

(BU7322HFV)

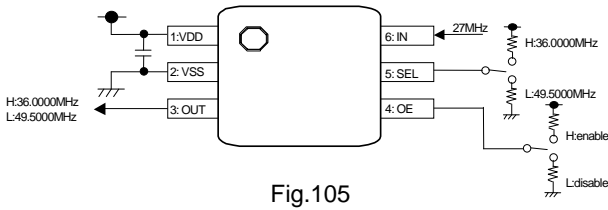

Fig.105

(BU7325HFV)

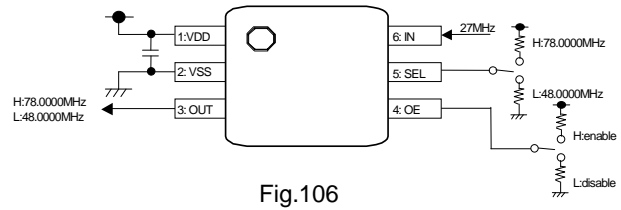

Fig.106

- \* For VDD and VSS, insert a bypass capacitor of approx. 0.1 μF as close as possible to the pin.
- \* Bypass capacitors with good high-frequency characteristics are recommended.
- \* Even though we believe that the typical application circuit is worth of a recommendation, please be sure to thoroughly recheck the characteristics before use.

●Equivalent circuit

3-pin (Output pin)

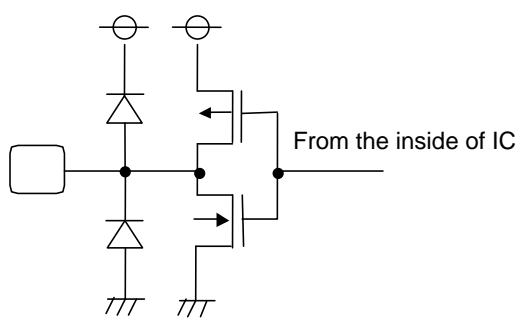

Fig.107

BU3071HFV, BU3073HFV, BU3076HFV  
BU7322HFV, BU7325HFV

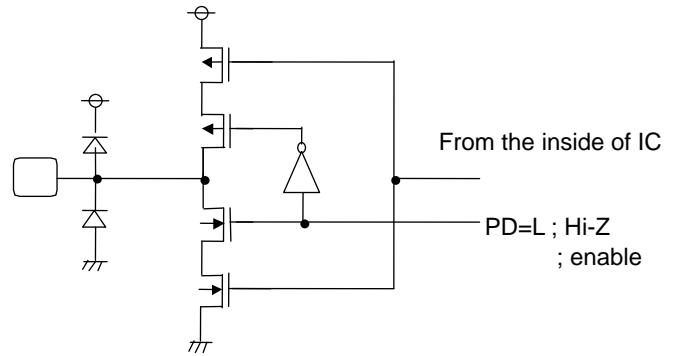

Fig.108

BU3072HFV

4-pin (Input pin)

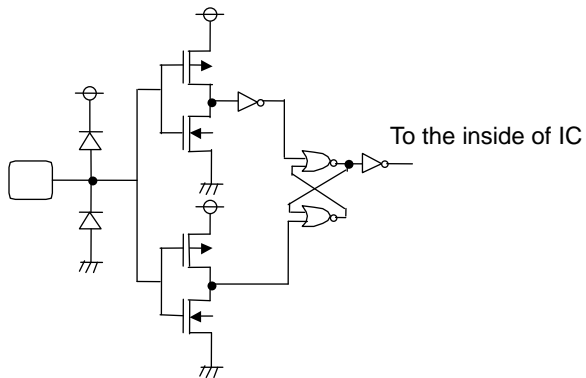

Fig.109

5-pin (Input pin)

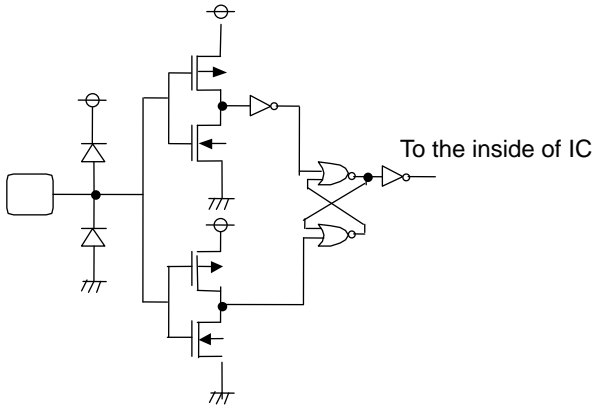

Fig.110  
BU3072HFV, BU3073HFV, BU3076HFV  
BU7322HFV, BU7325HFV

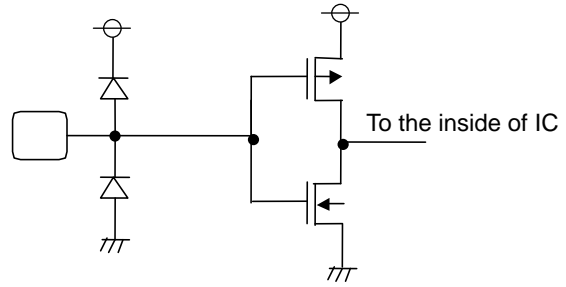

Fig.111  
BU3071HFV

6-pin (Input pin)

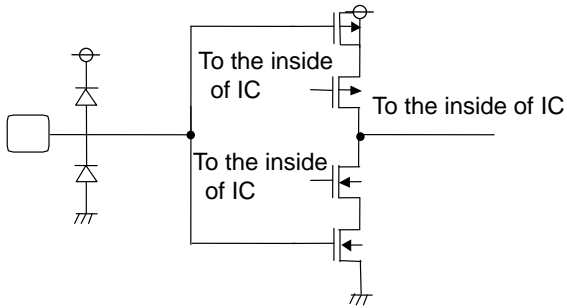

Fig.112  
BU3072HFV, BU3073HFV, BU3076HFV  
BU7322HFV, BU7325HFV

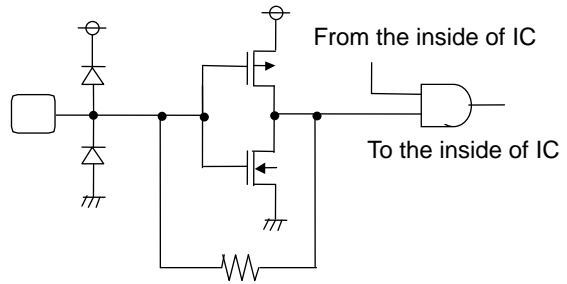

Fig.113  
BU3071HFV

● Appearance of Marker

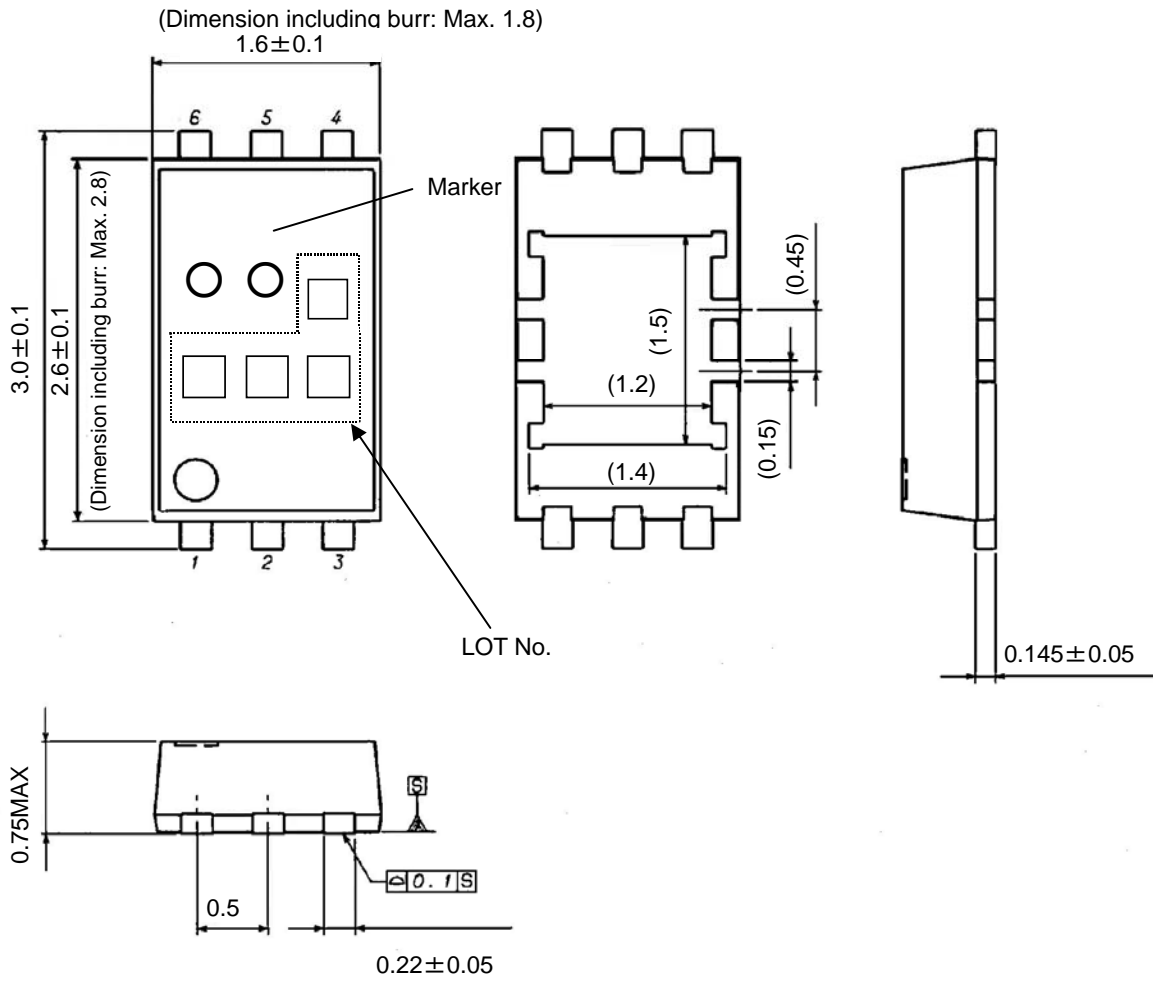

Fig.114

(UNIT : mm)

• List of markers

Model name	Marker
BU3071HFV	AB
BU3072HFV	AC
BU3073HFV	AD
BU3076HFV	AA
BU7322HFV	AE
BU7325HFV	AH

**●Notes for use**

- 1) Absolute Maximum Ratings  
An excess in the absolute maximum ratings, such as applied voltage (VDD or VIN), operating temperature range (Topr), etc., can break down devices, thus making impossible to identify breaking mode such as a short circuit or an open circuit. If any special mode exceeding the absolute maximum ratings is assumed, consideration should be given to take physical safety measures including the use of fuses, etc.
- 2) Recommended operating conditions  
These conditions represent a range within which characteristics can be provided approximately as expected. The electrical characteristics are guaranteed under the conditions of each parameter.
- 3) Reverse connection of power supply connector  
The reverse connection of power supply connector can break down ICs. Take protective measures against the breakdown due to the reverse connection, such as mounting an external diode between the power supply and the IC's power supply terminal.
- 4) Power supply line  
Design PCB pattern to provide low impedance for the wiring between the power supply and the GND lines.  
In this regard, for the digital block power supply and the analog block power supply, even though these power supplies has the same level of potential, separate the power supply pattern for the digital block from that for the analog block, thus suppressing the diffraction of digital noises to the analog block power supply resulting from impedance common to the wiring patterns. For the GND line, give consideration to design the patterns in a similar manner.  
Furthermore, for all power supply terminals to ICs, mount a capacitor between the power supply and the GND terminal. At the same time, in order to use an electrolytic capacitor, thoroughly check to be sure the characteristics of the capacitor to be used present no problem including the occurrence of capacity dropout at a low temperature, thus determining the constant.
- 5) GND voltage  
Make setting of the potential of the GND terminal so that it will be maintained at the minimum in any operating state. Furthermore, check to be sure no terminals are at a potential lower than the GND voltage including an actual electric transient.
- 6) Short circuit between terminals and erroneous mounting  
In order to mount ICs on a set PCB, pay thorough attention to the direction and offset of the ICs. Erroneous mounting can break down the ICs. Furthermore, if a short circuit occurs due to foreign matters entering between terminals or between the terminal and the power supply or the GND terminal, the ICs can break down.
- 7) Operation in strong electromagnetic field  
Be noted that using ICs in the strong electromagnetic field can malfunction them.
- 8) Inspection with set PCB  
On the inspection with the set PCB, if a capacitor is connected to a low-impedance IC terminal, the IC can suffer stress. Therefore, be sure to discharge from the set PCB by each process. Furthermore, in order to mount or dismount the set PCB to/from the jig for the inspection process, be sure to turn OFF the power supply and then mount the set PCB to the jig. After the completion of the inspection, be sure to turn OFF the power supply and then dismount it from the jig. In addition, for protection against static electricity, establish a ground for the assembly process and pay thorough attention to the transportation and the storage of the set PCB.
- 9) Input terminals  
In terms of the construction of IC, parasitic elements are inevitably formed in relation to potential. The operation of the parasitic element can cause interference with circuit operation, thus resulting in a malfunction and then breakdown of the input terminal. Therefore, pay thorough attention not to handle the input terminals, such as to apply to the input terminals a voltage lower than the GND respectively, so that any parasitic element will operate. Furthermore, do not apply a voltage to the input terminals when no power supply voltage is applied to the IC. In addition, even if the power supply voltage is applied, apply to the input terminals a voltage lower than the power supply voltage or within the guaranteed value of electrical characteristics.
- 10) Ground wiring pattern  
If small-signal GND and large-current GND are provided, It will be recommended to separate the large-current GND pattern from the small-signal GND pattern and establish a single ground at the reference point of the set PCB so that resistance to the wiring pattern and voltage fluctuations due to a large current will cause no fluctuations in voltages of the small-signal GND. Pay attention not to cause fluctuations in the GND wiring pattern of external parts as well.
- 11) External capacitor  
In order to use a ceramic capacitor as the external capacitor, determine the constant with consideration given to a degradation in the nominal capacitance due to DC bias and changes in the capacitance due to temperature, etc.

● Ordering part number

B	U
---	---

Part No.

3	0	7	1
---	---	---	---

Part No.  
3071, 3072, 3073  
3076, 7322, 7325

H	F	V
---	---	---

Package  
HFV : HVSO6

T	R
---	---

Packaging and forming specification  
TR: Embossed tape and reel

HVSO6

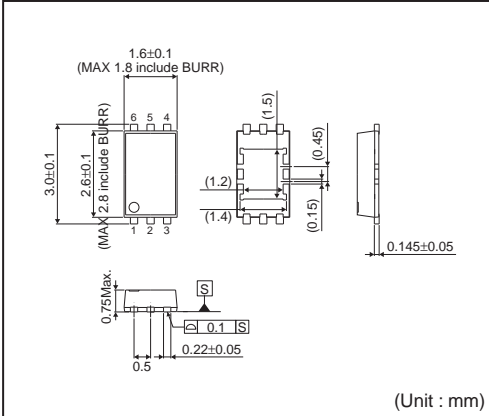

<Tape and Reel information>

Tape	Embossed carrier tape
Quantity	3000pcs
Direction of feed	TR (The direction is the 1 pin of product is at the upper right when you hold reel on the left hand and you pull out the tape on the right hand)

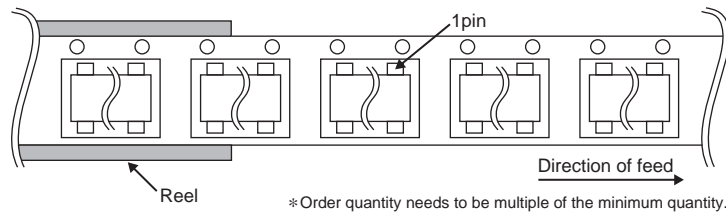

# Notice

## Precaution on using ROHM Products

- Our Products are designed and manufactured for application in ordinary electronic equipments (such as AV equipment, OA equipment, telecommunication equipment, home electronic appliances, amusement equipment, etc.). If you intend to use our Products in devices requiring extremely high reliability (such as medical equipment <sup>(Note 1)</sup>, transport equipment, traffic equipment, aircraft/spacecraft, nuclear power controllers, fuel controllers, car equipment including car accessories, safety devices, etc.) and whose malfunction or failure may cause loss of human life, bodily injury or serious damage to property ("Specific Applications"), please consult with the ROHM sales representative in advance. Unless otherwise agreed in writing by ROHM in advance, ROHM shall not be in any way responsible or liable for any damages, expenses or losses incurred by you or third parties arising from the use of any ROHM's Products for Specific Applications.

(Note1) Medical Equipment Classification of the Specific Applications

JAPAN	USA	EU	CHINA
CLASS III	CLASS III	CLASS II b	CLASS III
CLASS IV		CLASS III	

- ROHM designs and manufactures its Products subject to strict quality control system. However, semiconductor products can fail or malfunction at a certain rate. Please be sure to implement, at your own responsibilities, adequate safety measures including but not limited to fail-safe design against the physical injury, damage to any property, which a failure or malfunction of our Products may cause. The following are examples of safety measures:
  - Installation of protection circuits or other protective devices to improve system safety
  - Installation of redundant circuits to reduce the impact of single or multiple circuit failure
- Our Products are designed and manufactured for use under standard conditions and not under any special or extraordinary environments or conditions, as exemplified below. Accordingly, ROHM shall not be in any way responsible or liable for any damages, expenses or losses arising from the use of any ROHM's Products under any special or extraordinary environments or conditions. If you intend to use our Products under any special or extraordinary environments or conditions (as exemplified below), your independent verification and confirmation of product performance, reliability, etc. prior to use, must be necessary:
  - Use of our Products in any types of liquid, including water, oils, chemicals, and organic solvents
  - Use of our Products outdoors or in places where the Products are exposed to direct sunlight or dust
  - Use of our Products in places where the Products are exposed to sea wind or corrosive gases, including Cl<sub>2</sub>, H<sub>2</sub>S, NH<sub>3</sub>, SO<sub>2</sub>, and NO<sub>2</sub>
  - Use of our Products in places where the Products are exposed to static electricity or electromagnetic waves
  - Use of our Products in proximity to heat-producing components, plastic cords, or other flammable items
  - Sealing or coating our Products with resin or other coating materials
  - Use of our Products without cleaning residue of flux (even if you use no-clean type fluxes, cleaning residue of flux is recommended); or Washing our Products by using water or water-soluble cleaning agents for cleaning residue after soldering
  - Use of the Products in places subject to dew condensation
- The Products are not subject to radiation-proof design.
- Please verify and confirm characteristics of the final or mounted products in using the Products.
- In particular, if a transient load (a large amount of load applied in a short period of time, such as pulse. is applied, confirmation of performance characteristics after on-board mounting is strongly recommended. Avoid applying power exceeding normal rated power; exceeding the power rating under steady-state loading condition may negatively affect product performance and reliability.
- De-rate Power Dissipation (Pd) depending on Ambient temperature (Ta). When used in sealed area, confirm the actual ambient temperature.
- Confirm that operation temperature is within the specified range described in the product specification.
- ROHM shall not be in any way responsible or liable for failure induced under deviant condition from what is defined in this document.

## Precaution for Mounting / Circuit board design

- When a highly active halogenous (chlorine, bromine, etc.) flux is used, the residue of flux may negatively affect product performance and reliability.
- In principle, the reflow soldering method must be used; if flow soldering method is preferred, please consult with the ROHM representative in advance.

For details, please refer to ROHM Mounting specification

### Precautions Regarding Application Examples and External Circuits

1. If change is made to the constant of an external circuit, please allow a sufficient margin considering variations of the characteristics of the Products and external components, including transient characteristics, as well as static characteristics.
2. You agree that application notes, reference designs, and associated data and information contained in this document are presented only as guidance for Products use. Therefore, in case you use such information, you are solely responsible for it and you must exercise your own independent verification and judgment in the use of such information contained in this document. ROHM shall not be in any way responsible or liable for any damages, expenses or losses incurred by you or third parties arising from the use of such information.

### Precaution for Electrostatic

This Product is electrostatic sensitive product, which may be damaged due to electrostatic discharge. Please take proper caution in your manufacturing process and storage so that voltage exceeding the Products maximum rating will not be applied to Products. Please take special care under dry condition (e.g. Grounding of human body / equipment / solder iron, isolation from charged objects, setting of Ionizer, friction prevention and temperature / humidity control).

### Precaution for Storage / Transportation

1. Product performance and soldered connections may deteriorate if the Products are stored in the places where:
  - [a] the Products are exposed to sea winds or corrosive gases, including Cl<sub>2</sub>, H<sub>2</sub>S, NH<sub>3</sub>, SO<sub>2</sub>, and NO<sub>2</sub>
  - [b] the temperature or humidity exceeds those recommended by ROHM
  - [c] the Products are exposed to direct sunshine or condensation
  - [d] the Products are exposed to high Electrostatic
2. Even under ROHM recommended storage condition, solderability of products out of recommended storage time period may be degraded. It is strongly recommended to confirm solderability before using Products of which storage time is exceeding the recommended storage time period.
3. Store / transport cartons in the correct direction, which is indicated on a carton with a symbol. Otherwise bent leads may occur due to excessive stress applied when dropping of a carton.
4. Use Products within the specified time after opening a humidity barrier bag. Baking is required before using Products of which storage time is exceeding the recommended storage time period.

### Precaution for Product Label

QR code printed on ROHM Products label is for ROHM's internal use only.

### Precaution for Disposition

When disposing Products please dispose them properly using an authorized industry waste company.

### Precaution for Foreign Exchange and Foreign Trade act

Since our Products might fall under controlled goods prescribed by the applicable foreign exchange and foreign trade act, please consult with ROHM representative in case of export.

### Precaution Regarding Intellectual Property Rights

1. All information and data including but not limited to application example contained in this document is for reference only. ROHM does not warrant that foregoing information or data will not infringe any intellectual property rights or any other rights of any third party regarding such information or data. ROHM shall not be in any way responsible or liable for infringement of any intellectual property rights or other damages arising from use of such information or data.:
2. No license, expressly or implied, is granted hereby under any intellectual property rights or other rights of ROHM or any third parties with respect to the information contained in this document.

### Other Precaution

1. This document may not be reprinted or reproduced, in whole or in part, without prior written consent of ROHM.
2. The Products may not be disassembled, converted, modified, reproduced or otherwise changed without prior written consent of ROHM.
3. In no event shall you use in any way whatsoever the Products and the related technical information contained in the Products or this document for any military purposes, including but not limited to, the development of mass-destruction weapons.
4. The proper names of companies or products described in this document are trademarks or registered trademarks of ROHM, its affiliated companies or third parties.

**General Precaution**

1. Before you use our Products, you are requested to carefully read this document and fully understand its contents. ROHM shall not be in any way responsible or liable for failure, malfunction or accident arising from the use of any ROHM's Products against warning, caution or note contained in this document.
2. All information contained in this document is current as of the issuing date and subject to change without any prior notice. Before purchasing or using ROHM's Products, please confirm the latest information with a ROHM sales representative.
3. The information contained in this document is provided on an "as is" basis and ROHM does not warrant that all information contained in this document is accurate and/or error-free. ROHM shall not be in any way responsible or liable for any damages, expenses or losses incurred by you or third parties resulting from inaccuracy or errors of or concerning such information.

# Mouser Electronics

Authorized Distributor

Click to View Pricing, Inventory, Delivery & Lifecycle Information:

[ROHM Semiconductor:](#)

[BU7325HFV-TR](#)