

Dual N-channel 100 V, 0.059 Ω typ., 5 A STripFET™ VII DeepGATE™ Power MOSFET in a PowerFLAT™ 5x6 double island package

Datasheet - production data

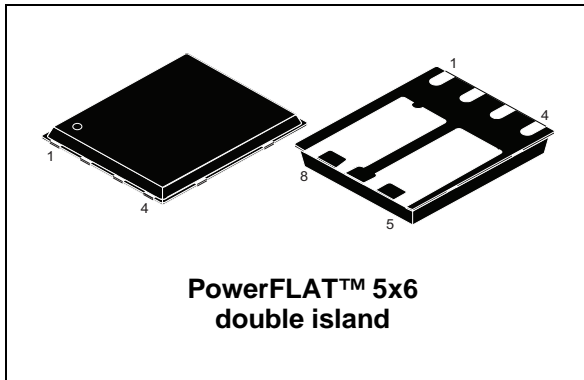

Features

Order code	V_{DS}	$R_{DS(on)}$ max	I_D
STL20DN10F7	100 V	0.067 Ω	5 A

- N-channel enhancement mode
- Lower $R_{DS(on)}$ x area vs previous generation
- 100% avalanche rated

Applications

- Switching applications

Description

This device utilizes the 7th generation of design rules of ST's proprietary STripFET™ technology, with a new gate structure. The resulting Power MOSFET exhibits the lowest $R_{DS(on)}$ in all packages.

Figure 1. Internal schematic diagram

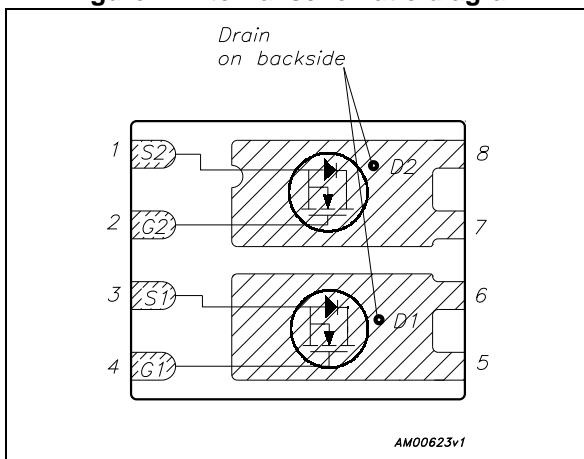

Table 1. Device summary

Order code	Marking	Package	Packaging
STL20DN10F7	20DN10F7	PowerFLAT™ 5x6 double island	Tape and reel

Contents

1	Electrical ratings	3
2	Electrical characteristics	4
	2.1 Electrical characteristics (curves)	6
3	Test circuits	8
4	Package mechanical data	9
5	Revision history	13

1 Electrical ratings

Table 2. Absolute maximum ratings

Symbol	Parameter	Value	Unit
V_{DS}	Drain-source voltage	100	V
V_{GS}	Gate-source voltage	± 20	V
$I_D^{(1)}$	Drain current (continuous) at $T_C = 25^\circ\text{C}$	20	A
$I_D^{(1)}$	Drain current (continuous) at $T_C = 100^\circ\text{C}$	12.3	A
$I_D^{(2)}$	Drain current (continuous) at $T_{pcb} = 25^\circ\text{C}$	5	A
$I_D^{(2)}$	Drain current (continuous) at $T_{pcb}=100^\circ\text{C}$	3.1	A
$I_{DM}^{(2), (3)}$	Drain current (pulsed)	20	A
$P_{TOT}^{(1)}$	Total dissipation at $T_C = 25^\circ\text{C}$	62.5	W
$P_{TOT}^{(2)}$	Total dissipation at $T_{pcb} = 25^\circ\text{C}$	4	W
T_J	Operating junction temperature	-55 to 150	$^\circ\text{C}$
T_{stg}	Storage temperature		$^\circ\text{C}$

1. The value is rated according R_{thj-c}
2. The value is rated according $R_{thj-pcb}$
3. Pulse width limited by safe operating area

Table 3. Thermal resistance

Symbol	Parameter	Value	Unit
$R_{thj-case}$	Thermal resistance junction-case	2	$^\circ\text{C}/\text{W}$
$R_{thj-pcb}^{(1)}$	Thermal resistance junction-pcb	32	$^\circ\text{C}/\text{W}$

1. When mounted on FR-4 board of 1inc^2 , 2oz Cu, $t < 10\text{ sec}$

2 Electrical characteristics

($T_{CASE}=25\text{ °C}$ unless otherwise specified)

Table 4. On/off states

Symbol	Parameter	Test conditions	Min.	Typ.	Max.	Unit
$V_{(BR)DSS}$	Drain-source breakdown voltage	$I_D = 250\ \mu A, V_{GS} = 0$	100			V
I_{DSS}	Zero gate voltage drain current ($V_{GS} = 0$)	$V_{DS} = 100\text{ V}$			1	μA
		$V_{DS} = 100\text{ V}, T_C = 125\text{ °C}$			100	μA
I_{GSS}	Gate body leakage current ($V_{DS} = 0$)	$V_{GS} = +20\text{ V}$			100	nA
$V_{GS(th)}$	Gate threshold voltage	$V_{DS} = V_{GS}, I_D = 250\ \mu A$	2.5		4.5	V
$R_{DS(on)}$	Static drain-source on-resistance	$V_{GS} = 10\text{ V}, I_D = 2.5\text{ A}$		0.059	0.067	Ω

Table 5. Dynamic

Symbol	Parameter	Test conditions	Min.	Typ.	Max.	Unit
C_{iss}	Input capacitance	$V_{DS} = 50\text{ V}, f = 1\text{ MHz}, V_{GS} = 0$	-	408	-	pF
C_{oss}	Output capacitance		-	112	-	pF
C_{rss}	Reverse transfer capacitance		-	10	-	pF
Q_g	Total gate charge	$V_{DD} = 50\text{ V}, I_D = 5\text{ A}$ $V_{GS} = 10\text{ V}$ (see Figure 14)	-	7.8	-	nC
Q_{gs}	Gate-source charge		-	3	-	nC
Q_{gd}	Gate-drain charge		-	1.7	-	nC

Table 6. Switching times

Symbol	Parameter	Test conditions	Min.	Typ.	Max.	Unit
$t_{d(on)}$	Turn-on delay time	$V_{DD} = 50\text{ V}, I_D = 2.5\text{ A}, R_G = 4.7\ \Omega, V_{GS} = 10\text{ V}$ (see Figure 13)	-	6.3	-	ns
t_r	Rise time		-	3	-	ns
$t_{d(off)}$	Turn-off delay time		-	11	-	ns
t_f	Fall time		-	4	-	ns

Table 7. Source drain diode

Symbol	Parameter	Test conditions	Min.	Typ.	Max.	Unit
I_{SD}	Source-drain current		-		5	A
$I_{SDM}^{(1)}$	Source-drain current (pulsed)		-		20	A
$V_{SD}^{(2)}$	Forward on voltage	$I_{SD}= 5 \text{ A}$, $V_{GS}=0$	-		1.1	V
t_{rr}	Reverse recovery time	$I_{SD}= 5 \text{ A}$, $di/dt = 100 \text{ A}/\mu\text{s}$, $V_{DD}= 80 \text{ V}$, $T_j=150 \text{ }^\circ\text{C}$ <i>(see Figure 18)</i>	-	30		ns
Q_{rr}	Reverse recovery charge		-	24		nC
I_{RRM}	Reverse recovery current		-	1.6		A

1. Pulse width limited by safe operating area.
2. Pulsed: pulse duration = 300 μs , duty cycle 1.5 %

2.1 Electrical characteristics (curves)

Figure 2. Safe operating area

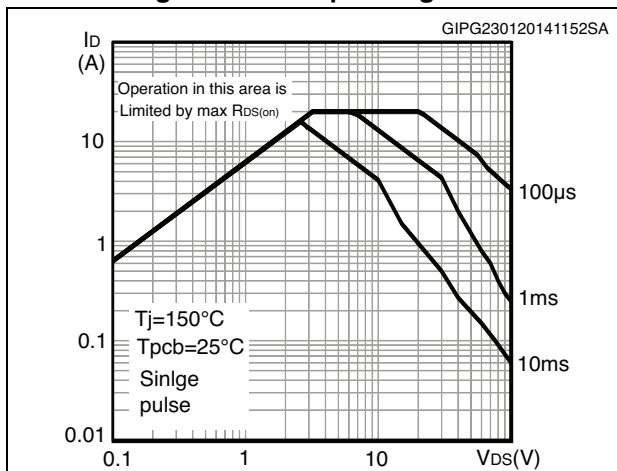

Figure 3. Thermal impedance

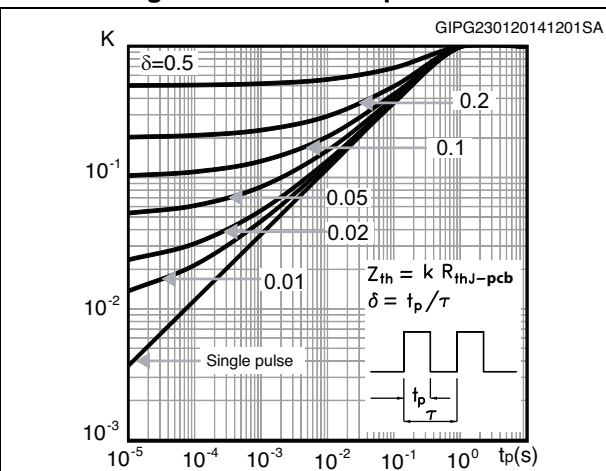

Figure 4. Output characteristics

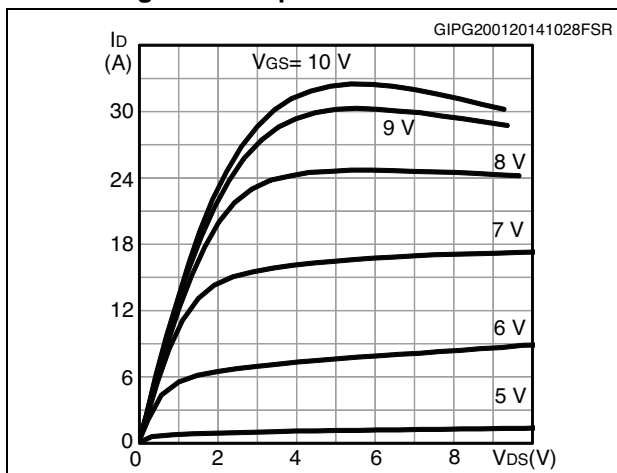

Figure 5. Transfer characteristics

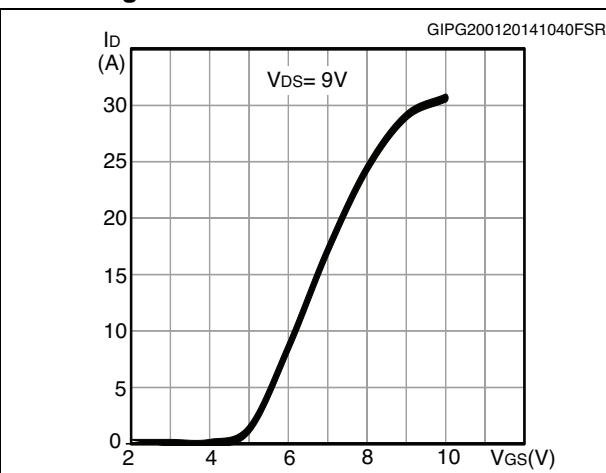

Figure 6. Gate charge vs gate-source voltage

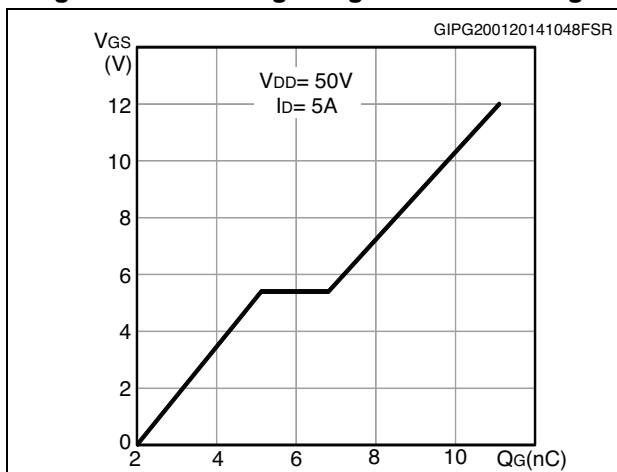

Figure 7. Static drain-source on-resistance

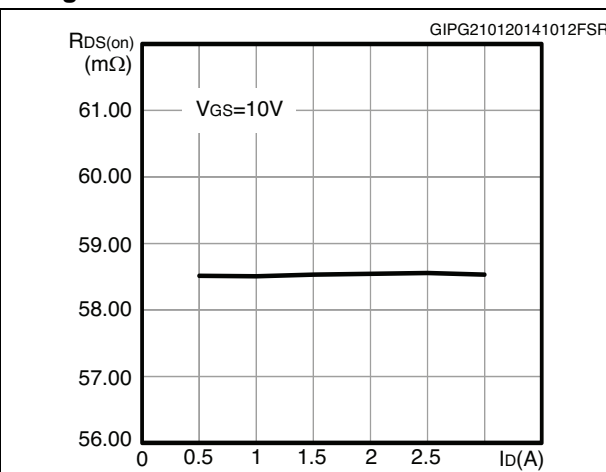

Figure 8. Capacitance variations

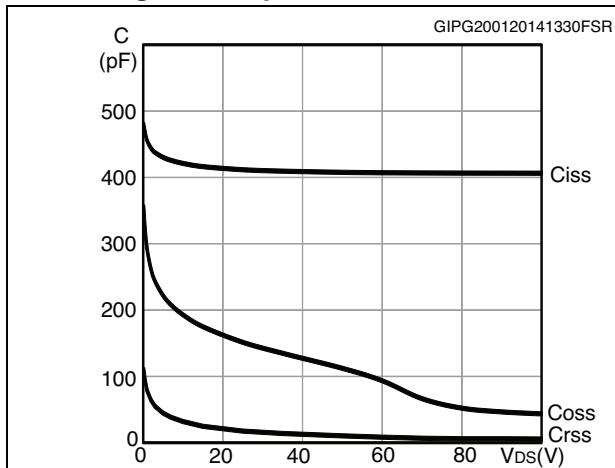

Figure 9. Normalized $V_{(BR)DSS}$ vs temperature

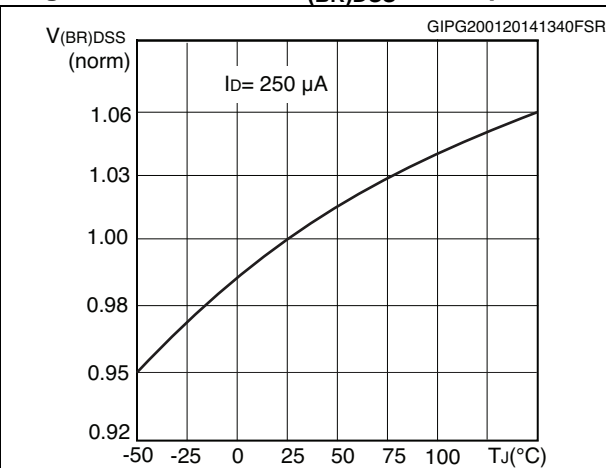

Figure 10. Normalized gate threshold voltage vs temperature

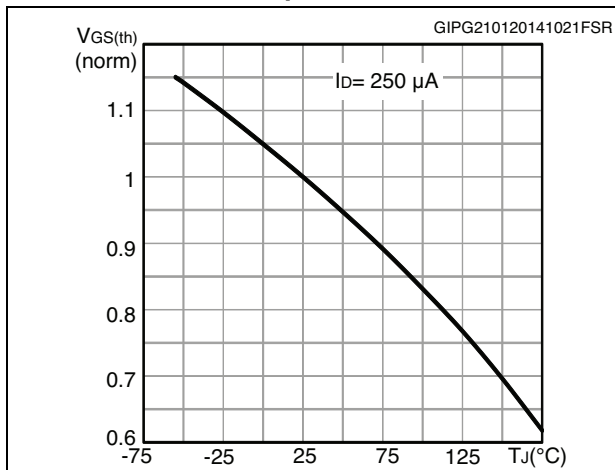

Figure 11. Normalized on-resistance vs temperature

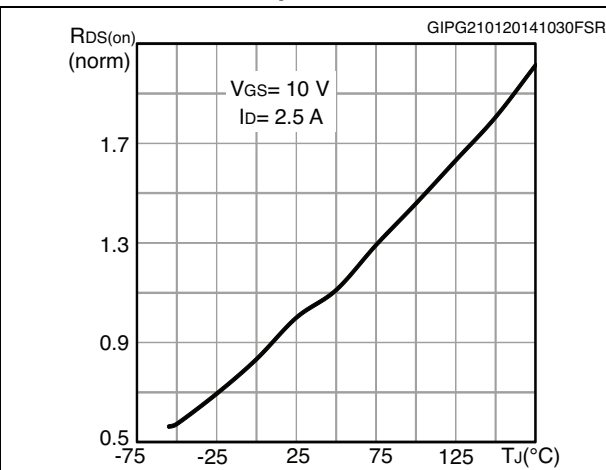
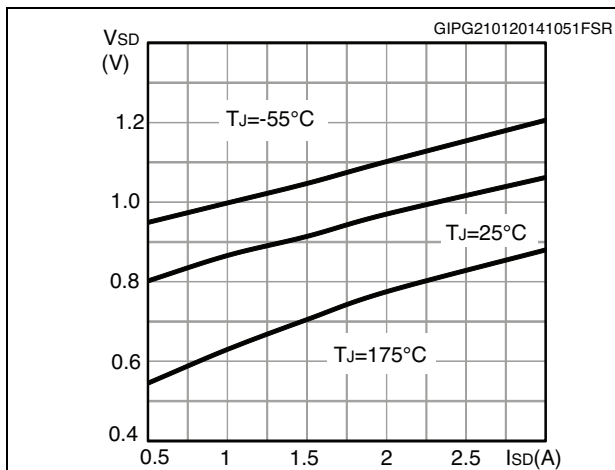

Figure 12. Source-drain diode forward characteristics



3 Test circuits

Figure 13. Switching times test circuit for resistive load



Figure 14. Gate charge test circuit

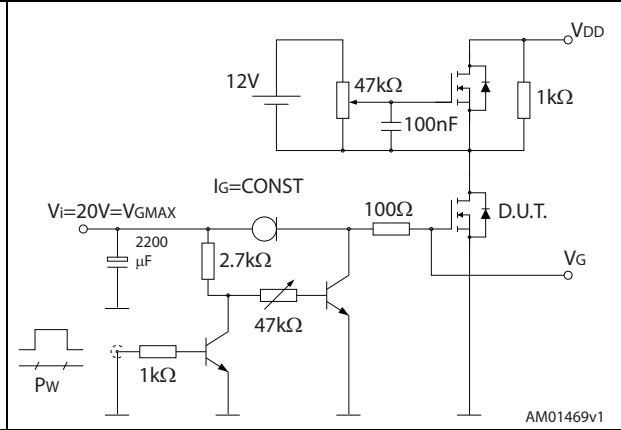

Figure 15. Test circuit for inductive load switching and diode recovery times



Figure 16. Unclamped inductive load test circuit



Figure 17. Unclamped inductive waveform



Figure 18. Switching time waveform



4 Package mechanical data

In order to meet environmental requirements, ST offers these devices in different grades of ECOPACK[®] packages, depending on their level of environmental compliance. ECOPACK[®] specifications, grade definitions and product status are available at: www.st.com. ECOPACK[®] is an ST trademark.

Figure 19. PowerFLAT™ 5x6 - double island type R-B drawing

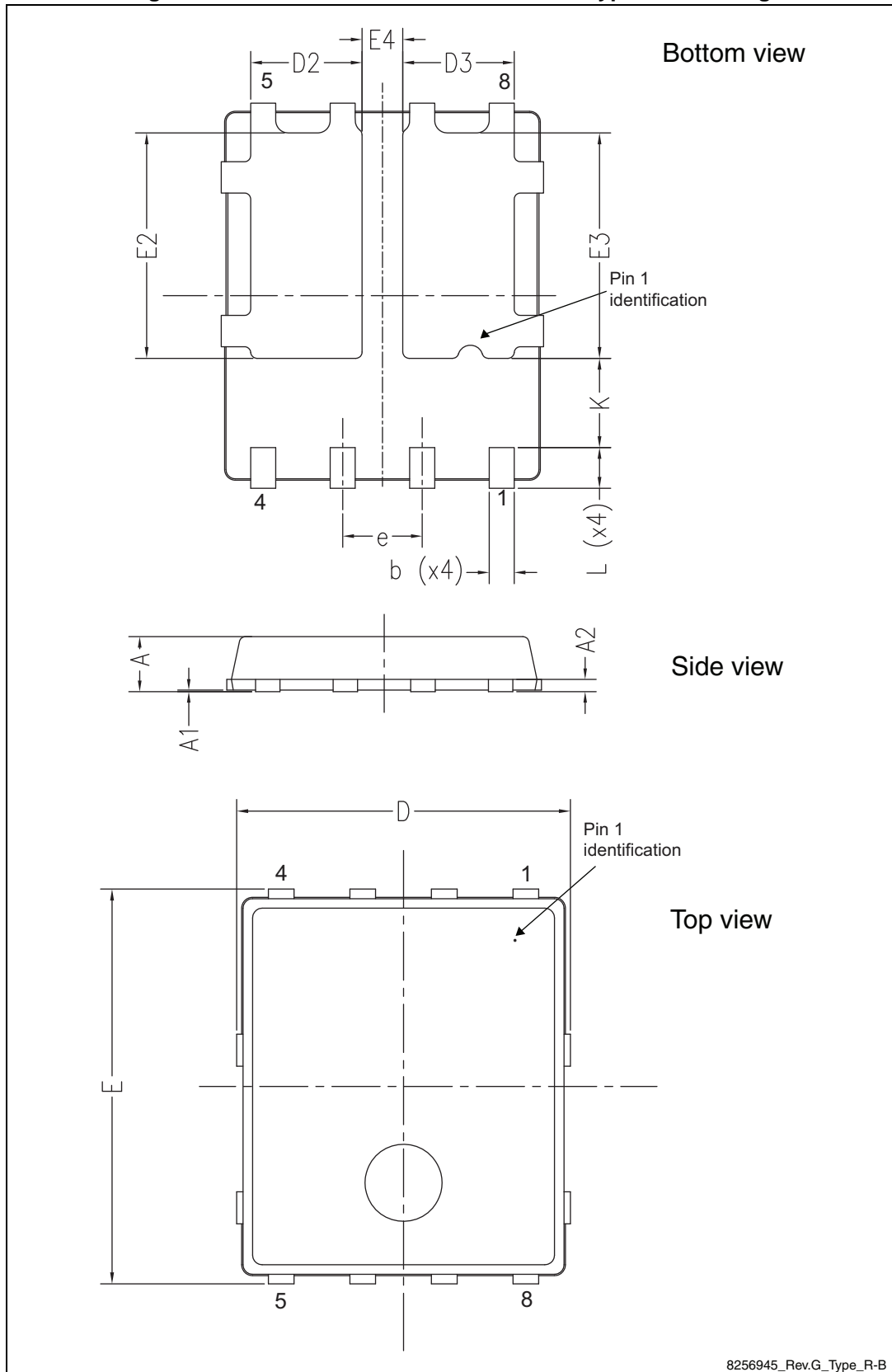

8256945_Rev.G_Type_R-B

Table 8. PowerFLAT™ 5x6 - double island type R-B mechanical data

Ref.	Dimensions (mm)		
	Min.	Typ.	Max.
A	0.80		1.00
A1	0.02		0.05
A2		0.25	
b	0.30		0.50
D	5.00	5.20	5.40
E	5.95	6.15	6.35
D2	1.68		1.88
E2	3.50		3.70
D3	1.68		1.88
E3	3.50		3.70
E4	0.55		0.75
e		1.27	
L	0.60		0.80
K	1.275		1.575

Figure 20. PowerFLAT™ 5x6 - double island type R-B drawing recommended footprint (dimensions are in mm)

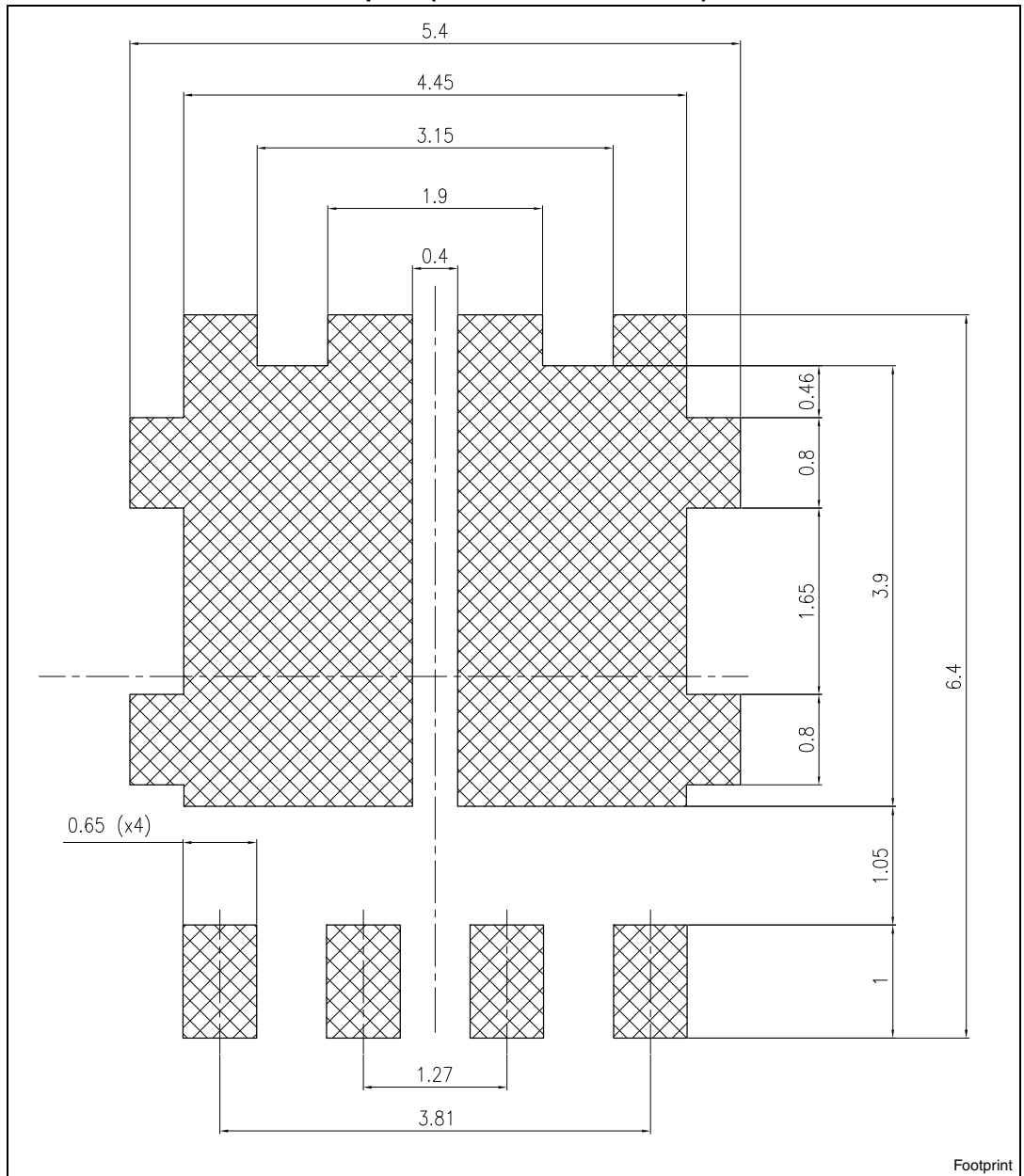

5 Revision history

Table 9. Document revision history

Date	Revision	Changes
19-Nov-2012	1	First release.
18-Feb-2014	2	<ul style="list-style-type: none"> – Modified: $R_{DS(on)}$ value in cover page – Modified: I_{DSS}, I_{GSS}, $V_{GS(th)}$ and $R_{DS(on)}$ values in Table 4 – Modified: the entire typical values in Table 5 and 6 – Updated: Section 4: Package mechanical data – Minor text changes
02-Apr-2014	3	<ul style="list-style-type: none"> – Document status promoted from preliminary to production data – Modified: Figure 7, 10, 11 – Updated: Section 4: Package mechanical data – Minor text changes

Please Read Carefully:

Information in this document is provided solely in connection with ST products. STMicroelectronics NV and its subsidiaries ("ST") reserve the right to make changes, corrections, modifications or improvements, to this document, and the products and services described herein at any time, without notice.

All ST products are sold pursuant to ST's terms and conditions of sale.

Purchasers are solely responsible for the choice, selection and use of the ST products and services described herein, and ST assumes no liability whatsoever relating to the choice, selection or use of the ST products and services described herein.

No license, express or implied, by estoppel or otherwise, to any intellectual property rights is granted under this document. If any part of this document refers to any third party products or services it shall not be deemed a license grant by ST for the use of such third party products or services, or any intellectual property contained therein or considered as a warranty covering the use in any manner whatsoever of such third party products or services or any intellectual property contained therein.

UNLESS OTHERWISE SET FORTH IN ST'S TERMS AND CONDITIONS OF SALE ST DISCLAIMS ANY EXPRESS OR IMPLIED WARRANTY WITH RESPECT TO THE USE AND/OR SALE OF ST PRODUCTS INCLUDING WITHOUT LIMITATION IMPLIED WARRANTIES OF MERCHANTABILITY, FITNESS FOR A PARTICULAR PURPOSE (AND THEIR EQUIVALENTS UNDER THE LAWS OF ANY JURISDICTION), OR INFRINGEMENT OF ANY PATENT, COPYRIGHT OR OTHER INTELLECTUAL PROPERTY RIGHT.

ST PRODUCTS ARE NOT DESIGNED OR AUTHORIZED FOR USE IN: (A) SAFETY CRITICAL APPLICATIONS SUCH AS LIFE SUPPORTING, ACTIVE IMPLANTED DEVICES OR SYSTEMS WITH PRODUCT FUNCTIONAL SAFETY REQUIREMENTS; (B) AERONAUTIC APPLICATIONS; (C) AUTOMOTIVE APPLICATIONS OR ENVIRONMENTS, AND/OR (D) AEROSPACE APPLICATIONS OR ENVIRONMENTS. WHERE ST PRODUCTS ARE NOT DESIGNED FOR SUCH USE, THE PURCHASER SHALL USE PRODUCTS AT PURCHASER'S SOLE RISK, EVEN IF ST HAS BEEN INFORMED IN WRITING OF SUCH USAGE, UNLESS A PRODUCT IS EXPRESSLY DESIGNATED BY ST AS BEING INTENDED FOR "AUTOMOTIVE, AUTOMOTIVE SAFETY OR MEDICAL" INDUSTRY DOMAINS ACCORDING TO ST PRODUCT DESIGN SPECIFICATIONS. PRODUCTS FORMALLY ESCC, QML OR JAN QUALIFIED ARE DEEMED SUITABLE FOR USE IN AEROSPACE BY THE CORRESPONDING GOVERNMENTAL AGENCY.

Resale of ST products with provisions different from the statements and/or technical features set forth in this document shall immediately void any warranty granted by ST for the ST product or service described herein and shall not create or extend in any manner whatsoever, any liability of ST.

ST and the ST logo are trademarks or registered trademarks of ST in various countries.

Information in this document supersedes and replaces all information previously supplied.

The ST logo is a registered trademark of STMicroelectronics. All other names are the property of their respective owners.

© 2014 STMicroelectronics - All rights reserved

STMicroelectronics group of companies

Australia - Belgium - Brazil - Canada - China - Czech Republic - Finland - France - Germany - Hong Kong - India - Israel - Italy - Japan - Malaysia - Malta - Morocco - Philippines - Singapore - Spain - Sweden - Switzerland - United Kingdom - United States of America

www.st.com

Mouser Electronics

Authorized Distributor

Click to View Pricing, Inventory, Delivery & Lifecycle Information:

[STMicroelectronics:](#)

[STL20DN10F7](#)